

# 78th Anniversary Production Sale

Tuesday April 11th, 2023

Industry Leader for  
Low Maintenance, Maternal Traits



YEARS

**1** **Beckton**  
**Red Angus**

*Foundation Herd of the Red Angus Breed*

# 1 Beckton Red Angus

37 Beckton Drive • Sheridan, WY 82801 • [becktonwyo@gmail.com](mailto:becktonwyo@gmail.com)  
Office: 307.674.6095 • Evenings: 674.8162 • Fax: 672.7281

Dear Friends and Cattlemen,

Welcome to Beckton's 78th Anniversary Sale!! It has been that long since our family started putting together the very first herd of Red Angus cattle, basing our new herd on genetic science and selection. The cattle and genetics have come a long way since then. This year both bulls and heifers have come through a cold and snowy winter, but they have done very well. The bulls were wintered in a new and smaller location this year. The owner/operator walks through them every day, and it shows with their easy handling disposition.

Ag economists have long known that the traits which most improve ranch profitability are calving percentage and weaning percentage, the "maternal" traits like fertility, milk and calving ease. Beckton genetics are famous for maternal traits, and for the quality of replacement females and brood cows they produce. 38 of the top 50 sires in the breed for HerdBuilder Index are Beckton sires, or descended from Beckton sires.

Beckton genetics have superb growth as well, and excellent carcass traits which are becoming increasingly important. 44 of the top 50 sires for Marbling EPD are Beckton sires or descended from Beckton sires. Since 2007 we have been selecting for beef "Tenderness" as well. It is well known from meat science that the Calpain and Calpastatin enzymes are important to the tenderness and eating quality of beef. These can be measured using DNA, and scored on a 1 to 10 scale, with 10 being the best for beef tenderness. The beef industry average is about 6. Most Beckton sires are 9's and 10's.

We welcome you again to our 78th Anniversary bull and heifer sale. Please stay a little if you can and join us for our complimentary prime rib dinner at the Ramada Plaza right after the sale ends. We look forward to seeing you, and helping you in the future.

Sincerely,

*Cam Forbes*

Tenderness Scores	
DNA	Ultrasound
9-10 Outstanding	0.8-1.6 Tender+
7-8 Very Good	1.7-2.5 Tender
5-6 Average	2.6-4.0 Tender-
3-4 Poor	4.1-6.0 Fair to Tough
1-3 Very Poor	



• Since 1945  
Red Angus Breed

# 78th Anniversary Production Sale



## Some Facts about the Beckton Herd

Beckton has long been one of America's premier breeders recognized for genetics which combine a genuine balance of desirable traits - calving ease, maternal traits, and rapid growth to yearling age. They are a leading choice for commercial replacement females and for building a great cow herd. And the lower birth weights make them a first choice for breeding heifers.

**HERDBUIDER:** 9 of the top 10 highest ranking sires (and 38 of the top 50 sires) on the **Red Angus Herd Builder Index** for overall profitability are Beckton sires or descended from Beckton sires. To build a great cow herd with the best opportunity for long term profitability, Beckton has the best genetics that can do that for you.

**EASY CALVING:** Beckton has long been the choice for easy calving sires that still have gain and growth. 9 of the top 10 highest ranking sires in the breed for **Calving Ease EPD** (and 44 of the top 50 sires) are Beckton sires or descended from Beckton sires.

**HERD STAYABILITY:** Beckton is the #1 Herd in the Red Angus breed for Stayability, and has been for many years. 15 of the top 20 highest ranking sires in the breed for **Stayability EPD** are Beckton sires or descended from Beckton sires.

**CARCASS QUALITY:** For **Marbling EPD**, 8 of the top 10 highest ranking sires (and 44 of the top 50 sires) are Beckton sires or descended from Beckton sires. Beckton genetics are very popular for grass fed and natural beef programs. Raised and developed on our short grass and mountain pastures here in northern Wyoming, and upgraded from Angus origins, they are a natural source for these private beef marketing programs. We have regular bull customers in most states from California to Texas to Maine and most states in between, who want our genetics for **easy marbling, early maturity, ability to gain on grass and roughage, and high scoring beef tenderness**.

**MODERATE MATURE SIZE:** One characteristic of Beckton cattle which makes them ideal for producing replacement females and building a low cost, efficient cowherd, is the **moderate mature size**. We list the mature weight of the Dam of every Beckton sale bull. Page 5 shows the results of decades of genetic selection. We believe we have the best genetics for **Efficiency** that can be found anywhere.

## Beckton Ranch

37 Beckton Drive

9½ miles West of Sheridan

Phone: 307.674.6095

Please join us for a complimentary dinner after the sale at the Ramada Plaza (formerly the Holiday Inn).

**Tuesday, April 11th, 2023**

1 o'clock pm (Lunch at noon)

## 240 Bulls - 32 Heifers

Selling in catalog order, heifers sell following the bulls

## Catalog Table of Contents

Sale Information.....	2
The Beckton Program.....	4
Beckton History.....	8
The Bulls.....	10
The Yearling Heifers.....	61
Our Reference Sires.....	68
Reference Sire Lot Index.....	78
Sale Terms and Conditions.....	79
RAAA Herd EPD Tables.....	80
Sire Bloodline Charts.....	82
Lot-Tag Cross Reference.....	84

# Sale Information

**Catalog Order:** The animals sell in catalog order. We will have a conference call available for telephone bidding. You must register in advance, and conference number and instructions will be available then.

**Health Program:** Beckton has a comprehensive herd-wide health program which includes vaccinations for 7-Way, IBR, BVD, PI3, BRSV, Lepto, and ivermectin. The heifers are also vaccinated for bangs and vibrio.

**Fertility Tested:** All bulls have passed a rigorous fertility exam that included live semen evaluation, scrotal measurements, and reproductive tract examinations.

**All Bulls "Trich" Tested:** In all the years we have been selling and delivering bulls, Beckton has never had a bull test positive for "trich". But because an increasing number of states require testing of yearling bulls, and to avoid any delay in delivery time, we will have all the sale bulls tested negative for "trich" prior to the sale. Customers from any state may also come to the sale with their trailer and load out directly after the sale.

**Osteopetrosis Tested:** When a genetic test was developed by RAAA for osteopetrosis (OS), Beckton tested every sire in use in our program, as well as our major AI sires. Every Beckton bred sire (nearly 80 in total) tested OS Free.

**Semen Collection:** We plan to have semen collected on some of the bulls before the sale. We will also work with the buyer to collect bulls after the sale.

**Semen Interest Retention:** Buyer receives full possession and one half semen interest in all the bulls in the catalog. Seller is retaining one half interest in all bulls in the catalog. This is done so we can use some of the bulls in herd and reserve the right to collect and market semen on these bulls. Any collection on our behalf would be at our expense and could be done during the off-season and at the convenience of the buyer. The buyer would have the option to share in the collection and retain semen for the buyer's use also. If semen is marketed by either party, Seller receives one half royalty interest on gross semen sales, and buyer receives one half interest. Regardless of semen collection and marketing, the buyer retains full possession, full pasture use rights, and full salvage value in these bulls.

**Free Delivery:** We provide free delivery for all bulls throughout the continental U.S. If you bring a trailer to haul your own, \$200 will be deducted from the price of each bull. Heifers will be delivered free within 400 miles, and at cost for additional miles. Most of the sale cattle will be delivered from 1 to 3 weeks after the sale, although we will try to accommodate if you need your bulls right away. Although there occasionally are limitations, in most cases we can deliver the cattle directly to your ranch.

**Payment:** Payments can be made with cash, check payable to Beckton Stock Farm, Inc. or Visa/Mastercard on sale day.



Auctioneer Roger Jacobs  
406-698-7686



Curt Cox  
Wyoming Livestock Roundup  
307-630-4604



Brady Williams  
Tri-State Livestock  
406-938-3071



Pete Crow  
Western Livestock Journal  
303-722-7600

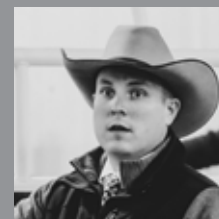

Devin Murnin  
Western Livestock Journal  
406-696-1502



Bob Hough  
817-296-0976



Alan Sears  
Western Ag Reporter  
970-454-3986

## BECKTON BULL AND HEIFER WARRANTY

Optional protection against injury or death, plus Pregnancy coverage for heifers

**BULLS:** Injury or loss protection coverage - If your bull is permanently injured or dies any time up to 5 months after purchase, you will receive a credit toward purchase of another bull in the amount of the original purchase price minus salvage. The cost is 5% of the purchase price paid at settlement (eg. \$150 for a \$3,000 bull).

**HEIFERS:** Injury or loss protection plus Pregnancy Guarantee - likewise good for 5 months after purchase. If your heifer fails to become pregnant when exposed to a bull who settles 75% of the other heifers in the same pasture; or in the event your heifer is permanently injured or dies, you will receive a credit toward purchase of another heifer in the amount of the original purchase price minus any salvage. The cost is 10% of the purchase price paid at settlement (eg. \$200 for a \$2,000 heifer).

## Accommodations

### Ramada Plaza

307-672-8931, I-90, Exit 25  
Ask for special Beckton Sale rate

### Best Western Sheridan Center

307-674-7421, 612 N. Main Street

### Days Inn

307-672-2888, 1104 Brundage Lane

### Super 8 Motel

307-672-9725, 2435 N. Main Street

## Transportation

### United Airlines

Daily flights to/from Denver  
united.com

### Avis Car Rental

307-672-2226, Sheridan Airport

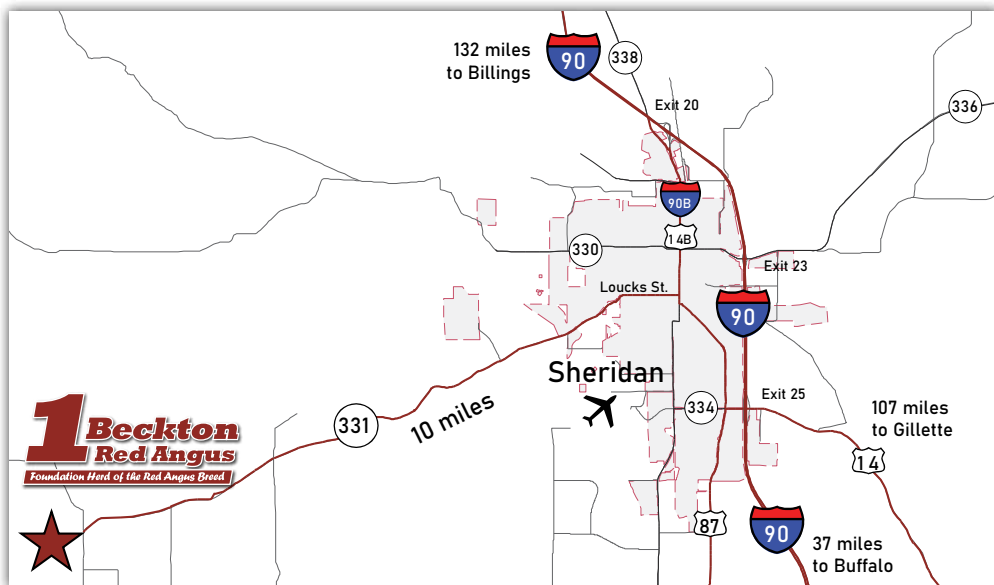

## How to Participate as an Absentee Bidder

Buyers purchasing via Superior or Pelton Livestock can mail a check after the sale with brief delivery instructions and an approximate date you would like delivery by. If you would like to pay with a credit card, please call the office the day after the sale.

### 1. Site-Unseen Purchase

If you are unable to attend the sale, we can help you select the bulls or heifers to fit your needs. Give us a call, letter, fax or email, and we can handle bidding for you according to your directions. Satisfaction is guaranteed on all animals purchased "sight-unseen". Over a quarter of our bulls sell this way, mostly to long-time and repeat customers. To provide adequate time to assist you, please contact us before sale day.

### 2. Superior Livestock Productions: Two Options

Pre-register at [www.superiorlivestock.com](http://www.superiorlivestock.com) prior to the sale, and then select one of the following methods to bid:

**Turn in Bids Over the Phone.** To get started simply go online to [www.superiorlivestock.com](http://www.superiorlivestock.com) and click on the tab titled "Register for a Buyer Number". Select the registration form for Superior Productions and print the registration form, fill it out and fax it in to Superior Productions at 817-378-3380 with a signature on it, or scan and email the form to [info@superiorauction.com](mailto:info@superiorauction.com). You can also mail it in to the address provided on the form. Upon receipt of this information Superior will call you with a buyer's number and the bid line phone number that you will use on sale day to place bids over the phone.



OR

**Online Click-To-Bid.** This is Superior's online bidding platform for cattle buying. Please note that high speed internet is required – this is not for dial-up or satellite internet. Registration is free, but you must become a member of [www.superiorclicktobid.com](http://www.superiorclicktobid.com) to sign up. Becoming a member is easy – just go to the homepage of [www.superiorclicktobid.com](http://www.superiorclicktobid.com) and follow the out-lined steps to get started. Input your information and select a username and password. You will receive an e-mail confirming you are a member. From that point forward you just have to sign in and select the sale you would like to register for and once approved you will receive an e-mail confirming which sale you are now registered for.

### 3. Pelton Livestock Sale Day Conference Call

Call Bill Pelton at 406-671-5100 or visit [www.billpelton.com](http://www.billpelton.com) in advance to pre-register for your buyer number, receive the toll-free call-in number and PIN, and get last minute instructions before the call.



Serving our customers for 78 years with industry leading genetics and the highest quality cattle.



# The Beckton Program



Beckton has used  
believe our

## Beckton's Efficiency Gain

Over the past 45 years, Beckton has been selecting for increased early rate of growth (to slaughter age) while holding cow weights constant. We have accomplished this by selecting for growth, restricting birth weight and cow size creep, and using rapid generation turnover to multiply each incremental change rapidly throughout our entire cowherd and all of our bloodlines. We have seen a dramatic increase in economic efficiency. **Our average cow weighs about 96% of what she weighed in 1978, but our average yearling weight is 128% of what it was in 1978.**

The U.S. cattle industry has also been increasing average steer slaughter weights, but industry-wide there has been no effort to control cow size. It turns out that industry cow weights are increasing at about the same percentage as steer and heifer slaughter weights. (Industry-wide, cows weigh 129% and steers weigh 133%, compared to 1978 weights). **Over 45 years, there has been minimal improvement in overall cow herd efficiency.** The increase in growth and value of market animals is being largely offset by the increase in feed requirements and maintenance cost of the mother cow herd.

The accompanying graphic shows the increase in efficiency of Beckton cattle compared to the U.S. beef industry. In the promotion of composites, the impact of retained heterosis on mature weight is too often ignored. Cross-breeding and composite breeding have done little more than simply increase general cattle size. Crossbreeding and composites are sold as a free lunch, but they aren't free.

### Cow Efficiency

We present two indicators of efficiency. The first is Weaning Percent, a simple percentage of calf 205 day weight divided by the dam's actual weight at weaning. The second is PRI Cow Efficiency. This also measures calf weaning weight, but relative to the cow's metabolic weight, and is expressed as an index above or below 100.

These efficiency measures are best used as indicators of where an animal is relative to others, rather than directly for selection. For example, if we see an animal with a low efficiency, we would look at the actual calf and cow weights to decide if the calf is too small, or the cow too big for the environment. That in turn will suggest corrective actions. In general, select for the traits you need to change to make cattle more efficient, and efficiency will be the result.



## The Beckton Crew today...



Randy Zier



Alan Sanders



Roger Zier

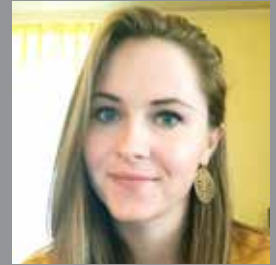

Shelby MacMillan



Allison Natzel



Matt Zier



Eli Hague



Grace Hague



Isaac Moss



Kyle Milliken

performance tested selection since 1945, and we cattle today are the most efficient in the industry.

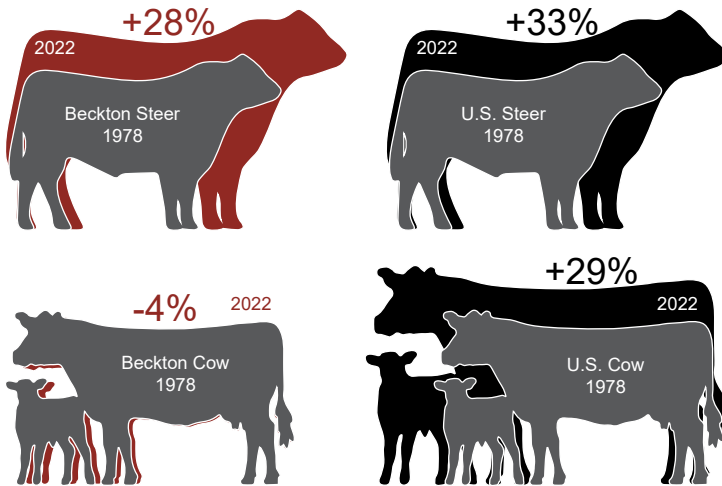

### Dam Information

A major difference with our catalog is the greater amount of information about the dams we provide. Weaning percent and Cow Efficiency are explained above. In addition, with each sale animal we give the dam's age when this calf was born, and the dam's actual weight when the calf was weaned the previous fall. We also provide her progeny averages — the average birth weight, weaning ratio, and yearling ratio — of her calves.



## Management

### **One Bull: the Simple Solution is the Best Solution**

Many cattlemen use Beckton bulls for their heifers because of their low birth weights and high calving ease. Our bulls are even better when used on cows, because replacement heifers tend to be selected from calves out of older cows. **Keeping replacement heifers sired by Beckton bulls is the quickest way to limit cow size creep and to moderate cow size for the future.** In our own program we use the same bulls on both heifers and cows. Every bull is used his first year with heifers to evaluate calving ease, and used in future years with older cows. We get calving ease, growth, and moderate-sized replacements, all with the same bull.

### **Quietness and Ease of Handling**

The necessity of record keeping means that our cattle will be handled much more than commercial cows. **This benefits our seedstock customers because our cattle will be quieter and easier to handle.** Good disposition is one of our most valued traits.

### **Selection for Industry Requirements**

In order to make selection decisions appropriate to the commercial beef industry, seedstock cattle need to be managed and measured under conditions which will approximate the commercial industry. **Our cows are run entirely on grass, with hay only if weather conditions require it, because that is how the commercial industry runs cows.** However,





almost all commercial calves go into feedlots before slaughter, so feedlot performance and efficiency is an important trait for calves. **Simply put, a producer needs to know how his cows perform on grass, and how his calves perform with feed.**

Our bulls are run on a performance test designed to provide the fairest basis of comparison among them, and this requires a compromise. Our bulls receive a “growing” ration high in roughage and protein and not as high in energy as a steer would receive. **We want to get a good measure of gainability with which to compare bulls, but we don’t want the bulls fat.**

## Beckton Performance

### Birth weight

- ★ Every sire entering our own program is used first on our own heifers, then on our cows.
- ★ We have never used high birth weight sires in any part of our program, so big birth weights are rare.
- ★ We get the pay weight, but with lower birth weights and greater calving ease.
- ★ Full production from heifers. We use the same bulls on heifers and cows.

### Growth

- ★ Weaning efficiency, and rate of gain to slaughter weight second to none.
- ★ Growth traits must be consistent with maintaining maternal qualities.
- ★ Beckton cattle are ideally sized for today’s packer demand.

### Hardiness

- ★ Every cow in the herd has spent part of her life in the Big Horn Mountain summer range, at elevations from 7000 to 10,500 feet.
- ★ In 2001 we PAP tested all of our herd sires. The herd average PAP score was 32.5 at 4000’, equivalent to a herd average PAP of 39 at 8000’ (excellent scores).
- ★ By the time she is 5, our average cow will have been trailed over 80 miles, above and beyond normal pasture rotation.

### Efficiency

- ★ The typical dam of our bulls weans over 50% of her body weight in 205 days, under range conditions, with no creep-feeding.
- ★ The average dam produces over 100% of her own body weight in a year.

### Fertility

- ★ Every bull in our program is used in natural service, with 30-50 heifers/cows.
- ★ Every cow in our program must cycle naturally and breed early under range conditions.

### Value

- ★ Beckton Red Angus produce more growth without high birth weights.
- ★ They are the one-bull solution that can be used on both heifers and cows.
- ★ Carcass quality is an extra benefit.

### Reliability

- ★ Beckton has been genetically improving Red Angus since 1945, a 30-60 year lead time over other producers.
- ★ It is a complete, genetically sound breeding program, which demands whole-herd performance.

# Beckton History

Beckton is one of the oldest ranches in the Sheridan, Wyoming area. It came into Forbes family ownership in 1899, and has grown since then. The home ranch lies in the foothills of the Bighorn Mountains, near the original Bozeman Trail. The site of the current ranch headquarters once included a post office and flour mill, founded by George Beck, from whom came the name "Beckton". George Beck's house, built in 1887, now serves as the Beckton ranch office.

In 1936, Waldo Forbes took over management of the Forbes family ranch. Waldo was interested in applying to beef cattle the ideas of performance testing and genetic selection for economically important traits. Waldo married Sal in 1939, just before World War II, and the two of them embarked on the undertaking that would make a contribution to the future direction of the beef industry — the establishment of an entirely new breed of cattle to be based on selection by performance traits of economic importance.

They bought top red calves from 18 leading registered Black Angus herds across the United States, using these red cattle to build the foundation herd of a new breed that was independent of existing breed associations. During the next decade, Beckton added many more red bulls and females from registered Black Angus herds. From early on, Beckton was active with crossbreeding their new Red Angus sires into their existing commercial Hereford herd, to create dual herds — one purebred Red Angus, and the other high-percentage Red Angus from the Hereford base. Today the two herds run side-by-side, sharing the use of our Red Angus sires.

In 1954 this new breed was formally established when the Red Angus Association of America was founded with performance testing as the cornerstone of breed improvement. Waldo served as the first president of the association until his death at the end of 1955. Sal served as the association's first Executive Secretary.

Today Beckton is the oldest and one of the largest Red Angus herds in the country, running approximately 1050 mother cows, 350 replacement females, and 100+ bulls (as well as several hundred deer and elk) on 15,000 deeded and State lease acres. Each year, much of the cowherd is moved to high mountain pastures in mid-summer. The ranch grows all its own hay, primarily as grass-alfalfa mixes.

The forage and other resources are managed as much for information as for production. Simply put, we don't manage the cattle to maximize weaning weights or even conception rates. Our business is maximizing information; therefore the cattle are pushed far beyond industry norms. For example, 90% of the main cowherd is bred in single sire pastures at a rate of 40-50 cows per bull. The other 10% of the cowherd is bred AI. Heifers are divided into groups of 20-30 per bull. All yearling bulls potentially

entering our program are used with a heifer group first, for comparative progeny testing and calving ease evaluation. Every bull in our program must be able to be used without difficulty on first-calf heifers as well as older cows.

Likewise, the stocking rate we use is higher than other purebred or commercial ranches would use in our area. The



Beckton Larkabeau O "220" in 1959, the 1st Red Angus Bull at ABS.



high stocking rate plus the scattered nature of our pastures and the high mountain ground, means the cattle are moved frequently. We once calculated that by the time she is five, our average cow has been trailed (not trucked) over 100 miles.

Our product is a package of genetic improvements which contribute to the production efficiency of other growers, both commercial and purebred. The value of our product derives from the information we can provide about its likely performance, combined with the reliability and consistency of our quality control. We use random mating almost exclusively to get meaningful and statistically unbiased data.

We believe that the most important livestock component of a commercial ranch is its cowherd, the focus of nearly all ranch costs. The cow is a production unit, with a set of costs attached, so the data we collect has to relate to the economics of that unit. The overwhelming share of operating costs depends on the quantity of feed required, not on the number of cows being run. For example, the cost of building and maintaining fence depends on the size of the pasture, not on the number of cows within the pasture. A focus on production efficiency has kept our cow size quite stable over the years. Birth EPD's give us an effective selection tool for managing mature size. We have also steadily improved the post-calving, pre-slaughter growth rate.

In summary, we have four basic production goals; to maximize the validity, usefulness and repeatability of our genetic information; to maximize the health and lifetime production capabilities of the animals we sell; to maximize the sustainability of our own natural resources, and to do all these things in the most efficient and cost-effective way possible. Ultimately, our success is measured by the success of the commercial beef producers who use our genetics.



Beckton house/office in 1899. The antlers are still on the porch, and it is one of the oldest buildings in Sheridan County.



Sal and Waldo enjoyed square dancing.



Young Sal Forbes up on the mountain.



1960s Beckton Sale with Berdon's broadcast van.



# The Bulls

Our bulls are managed in a manner to gain important performance data and information, and equally importantly, to develop and provide our customers with many years of productive service. We have been testing breeding bulls over 50 years, longer than almost any other producer. Our own breeding is based primarily on natural service, not AI, so we see how our bulls work in the pasture. We use bulls raised and managed just this way, with our own cows and heifers, on every kind of terrain, and high in the Bighorn Mountains.



Lot 182

## A few of our sale bulls this year...



## 1 Beckton Nebula K302 L5

1-A 100% # 4676415 Tat: BSF2 K302



Birth: 3-20-22  
 Beckton Nebula B557 J3 < Beckton Nebula P P707  
 Beckton Larkaba T813 JC  
**Beckton Nebula G249 N4**  
 Ref. N-4 < Beckton Nebula W022 D3  
 Beckton Lana W525 D  
 Beckton Legend S670 < Beckton Lancer F442 T  
 Beckton Kit F468 JL  
**Beckton Jane B220 L**  
 Beckton Jane P410 NP < Beckton Neptune R2 K065  
 Beckton Jane J874 CC

BWt	78
WR	106
YWt.	1124
YR	107
FebADG	3.05
Frame	5.0
Feet	Good

DAM	Age	Calv.Ease	BW	WW	YW	Milk	HPG	Stay	Maint.En.
8	8	13	-2.3	53	86	31	14	20	3.0
Wt	1260	EPDs							
Prog. BW	75	Marb	+0.46	REA	+0.04	Bfat	+0.03		
WR	107	Beef Tenderness	→	DNA	7 / Very Good	Scan	1.8 / Tender		
YR	107	HerdBuilder Index	79	Pct.	10%	ProS	116	Pct.	16%
Udder	Very Good	★★★★★ for Growth, Marbling, Superior Cow, Calving Ease.							
Wean Pct.	47%								
Cow Eff.	98								



Lot 1

## 2 Beckton Likable K294 A5

1-A 100% # 4675219 Tat: BKT2 K294



Birth: 3-20-22  
 Beckton Likable C229 R3 < Beckton Likable U130 L2  
 Beckton Tamara X447 J  
**Beckton Likable G403 N4**  
 Ref. L-6 < Beckton Minerva Y385 N  
 Beckton Minerva U310 LO  
 Beckton Accent W180 C2 < Beckton Cody K1 P014  
 Beckton Christy R046 CQ  
**Beckton Belga A160 A**  
 Beckton Belga W103 N < Beckton Nebula T398 V3  
 Beckton Belga T551 EP

BWt	77
WR	105
YWt.	1115
YR	112
FebADG	3.97
Frame	5.5
Feet	Good

DAM	Age	Calv.Ease	BW	WW	YW	Milk	HPG	Stay	Maint.En.
9	9	18	-4.7	64	107	27	11	23	0.0
Wt	1190	EPDs							
Prog. BW	67	Marb	+0.31	REA	-0.03	Bfat	+0.04		
WR	97	Beef Tenderness	→	DNA	10 / Outstanding	Scan	1.7 / Tender		
YR	107	HerdBuilder Index	103	Pct.	1%	ProS	146	Pct.	2%
Udder	Very Good	★★★★★ for Low Maintenance, Growth, Gainability, Marbling, Calving Ease.							
Wean Pct.	43%								
Cow Eff.	91								



Lot 2



Lot 3

## 3 Beckton Likable K250 L6

1-A 100% # 4675457 Tat: BKT2 K250



Birth: 3-17-22  
 Beckton Likable Z057 L4 < Beckton Likable X445 J3  
 Beckton Minola X107 L  
**Beckton Likable G289 J5**  
 Ref. L-5 < Beckton Julian GG B571  
 Beckton Coca B785 J < Beckton Coca X787 N  
 Beckton Likable Y124 L3 < Beckton Likable U130 L2  
 BKT Pine Marie S802 LO  
**Beckton Tamara D313 L**  
 Beckton Legend S670  
 Beckton Tamara X409 L < Beckton Tamara P243 JO

BWt	74
WR	115
YWt.	1079
YR	108
FebADG	3.40
Frame	5.5
Feet	Good

DAM	Age	Calv.Ease	BW	WW	YW	Milk	HPG	Stay	Maint.En.
6	6	15	-3.2	58	94	30	14	18	-1.0
Wt	1140	EPDs							
Prog. BW	70	Marb	+0.43	REA	+0.17	Bfat	+0.04		
WR	103	Beef Tenderness	→	DNA	10 / Outstanding	Scan	1.9 / Tender		
YR	116	HerdBuilder Index	77	Pct.	13%	ProS	106	Pct.	28%
Udder	Very Good	★★★★★ for Low Maintenance, Growth, Marbling, Rib-eye area, Superior Cow, Calving Ease.							
Wean Pct.	49%								
Cow Eff.	104								

\*Note: Scrotal and ultrasound data will be available later

**4****Beckton Accent K324 A4**

1-A 100% # 4676605 Tat: BSF2 K324



Birth: 3-22-22	Beckton Accent W180 C2	Beckton Cody K1 P014	BWt	77
	Beckton Accent F602 L3	Beckton Christy R046 CQ	WR	120
Ref. A-4	Beckton Lana B670 L	Beckton Likable U130 L2	YWt.	1074
		Beckton Lana Y541 W	YR	108
	Beckton Accent A175 O3	Beckton Accent W180 C2	FebADG	2.51
<b>Beckton Jane E340 A</b>		Beckton Lana R214 RA	Frame	5.5
	Beckton Jane B220 L	Beckton Legend S670	Feet	Good
		Beckton Jane P410 NP		

<b>DAM</b>	Calv.Ease	BW	WW	YW	Milk	HPG	Stay	Maint.En.		
Age	5	EPDs	15	-2.8	66	99	29	11	20	1.0
Wt	1110	Marb	+0.39		REA	+0.26		Bfat	+0.03	
Prog. BW	78	Beef Tenderness →	DNA: 6 / Average		Scan:	1.5 / Tender +				
WR	114	HerdBuilder Index:	94	Pct.: 2%	ProS:	109	Pct.: 24%			
YR	109	★★★★★ for Growth, Marbling, Rib-eye area, Superior Cow, Calving Ease.								
Udder	Very Good									
Wean Pct.	53%									
Cow Eff.	111									



Lot 4

**6****Beckton New Era K726 N2**

1-A 100% # 4676421 Tat: BSF2 K726



Birth: 4-19-22	Beckton Nebula P P707	Beckton Nebula M045	BWt	68
	<b>Beckton New Era Y194</b>	Beckton Lana M809 EP	WR	129
Ref. N-1	BKT Larkeisa T310 JC	Beckton Justice C1 R483	YWt.	1145
		BKT Larkeisa R775 JC	YR	114
	Beckton New Era Y194	Beckton Nebula P P707	FebADG	3.21
<b>Beckton Larkaba B277 N</b>		BKT Larkeisa T310 JC	Frame	5.5
	Beckton Larkaba U062 CB	Beckton Cobalt S029	Feet	Good
		Beckton Larkaba S374 NB		

<b>DAM</b>	Calv.Ease	BW	WW	YW	Milk	HPG	Stay	Maint.En.		
Age	8	EPDs	17	-4.3	67	107	29	15	20	5.0
Wt	1230	Marb	+0.34		REA	-0.05		Bfat	+0.03	
Prog. BW	69	Beef Tenderness →	DNA: 6 / Average		Scan:	1.8 / Tender				
WR	106	HerdBuilder Index:	73	Pct.: 18%	ProS:	103	Pct.: 32%			
YR	109	★★★★★ for Growth, Marbling, Superior Cow, Calving Ease.								
Udder	Very Good									
Wean Pct.	49%									
Cow Eff.	104									

**7****Beckton Jet K247 E3**

1-A 100% # 4676431 Tat: BSF2 K247



Birth: 3-17-22	Beckton Jet L P491	TR Julian Lt151	BWt	64
	<b>Beckton Jet G441 N2</b>	Beckton Minerva L278 LN	WR	113
Ref. J-5	Beckton Susan B246 N	Beckton New Era Y194	YWt.	1079
		Beckton Susan R022 CQ	YR	108
	Beckton Epic U749 D5	Beckton Epic K4 N795	FebADG	3.05
<b>Beckton Coca B405 E</b>		Beckton Denise R308 DM	Frame	5.5
	Beckton Coca W362 J	Beckton Justice C1 R483	Feet	Good
		Beckton Coca P440 JL		

<b>DAM</b>	Calv.Ease	BW	WW	YW	Milk	HPG	Stay	Maint.En.		
Age	8	EPDs	20	-6.8	53	85	32	11	16	6.0
Wt	1220	Marb	+0.47		REA	-0.04		Bfat	+0.04	
Prog. BW	61	Beef Tenderness →	DNA: 9 / Outstanding		Scan:	2.0 / Tender				
WR	107	HerdBuilder Index:	50	Pct.: 61%	ProS:	88	Pct.: 57%			
YR	103	★★★★★ for Growth, Marbling, Calving Ease.								
Udder	Fair									
Wean Pct.	45%									
Cow Eff.	95									



Lot 5

**5****Beckton New Era K561 L2**

1-A 100% # 4675289 Tat: BKT2 K561



Birth: 4-4-22	Beckton Nebula P P707	Beckton Nebula M045	BWt	91
	<b>Beckton New Era Y194</b>	Beckton Lana M809 EP	WR	121
Ref. N-1	BKT Larkeisa T310 JC	Beckton Justice C1 R483	YWt.	1176
		BKT Larkeisa R775 JC	YR	118
	Beckton Legend Z689 J3	Beckton Legend X561 J2	FebADG	4.83
<b>Beckton Susan B120 L</b>		Beckton Larkaba W868 J	Frame	5.5
	Beckton Susan Z427 L	Beckton Legend X561 J2	Feet	Good
		Beckton Susan W837 N		

<b>DAM</b>	Calv.Ease	BW	WW	YW	Milk	HPG	Stay	Maint.En.		
Age	8	EPDs	10	0.4	76	118	28	14	17	0.0
Wt	1020	Marb	+0.30		REA	+0.07		Bfat	+0.03	
Prog. BW	75	Beef Tenderness →	DNA: 10 / Outstanding		Scan:	1.6 / Tender +				
WR	108	HerdBuilder Index:	59	Pct.: 44%	ProS:	92	Pct.: 51%			
YR	104	★★★★★ for Low Maintenance, Growth, Gainability, Marbling, Superior Cow, Cow Efficiency.								
Udder	Very Good									
Wean Pct.	58%									
Cow Eff.	122									

\*Note: Scrotal and ultrasound data will be available later

**8** **Beckton Scamp K188 N7**   
 1-A 100% # 4676447 Tat: BSF2 K188

Birth: 3-11-22  
 Beckton Scamp D325 N5 < Beckton Scamp A627 J4  
 Beckton Scamp G236 L6 < Beckton Tamara Y039 N  
 Ref. S-3 < Beckton Likable U130 L2  
 Beckton Indigo Y406 L < Beckton Indigo R745 WR  
 Beckton Nebula Z180 H4 < Beckton Nebula X353 E3  
 Beckton Barmaid B802 N < Beckton Mona X817 H  
 Beckton Barmaid Z227 C < Beckton Clifftop W577 E3  
 Beckton Barmaid P323 HR

BWt	65
WR	100
YWt.	1022
YR	103
FebADG	3.78
Frame	5.0
Feet	Good

DAM		Calv.Ease	BW	WW	YW	Milk	HPG	Stay	Maint.En.	
Age	8	EPDs	17	-5.3	57	94	29	NA	15	-7.0
Wt	1050	Marb	+.25		REA	-.07		Bfat	+.03	
Prog. BW	64	Beef Tenderness →	DNA: 8 / Very Good		Scan: 1.7 / Tender					
WR	98	HerdBuilder Index: 65	Pct.: 31%		ProS: 91	Pct.: 52%				
YR	103	★★★★★ for Low Maintenance, Gainability, Marbling, Calving Ease.								
Udder	Very Good									
Wean Pct.	46%									
Cow Eff.	97									



Lot 8



Lot 7

**10** **BSF Nebula K295 N5**   
 1-B 99% # 4676367 Tat: BSF2 K295

Birth: 3-20-22  
 Beckton Nebula B557 J3 < Beckton Nebula P P707  
 Beckton Nebula G249 N4 < Beckton Larkaba T813 JC  
 Ref. N-4 < Beckton Nebula W022 D3  
 Beckton Lana Y130 N < Beckton Lana W525 D  
 Beckton Nomad X290 N3 < Beckton Nomad V 9871  
 BSF Nebulann Z158 N < Beckton Birdie S110 NB  
 BSF Nebulann X483 J < Beckton Roman J S158  
 BSF Nebulann R163 NB

BWt	75
WR	118
YWt.	1191
YR	118
FebADG	3.91
Frame	5.5
Feet	Good

DAM		Calv.Ease	BW	WW	YW	Milk	HPG	Stay	Maint.En.	
Age	10	EPDs	16	-4.4	63	108	31	12	15	-2.0
Wt	1070	Marb	+.42		REA	-.05		Bfat	+.03	
Prog. BW	65	Beef Tenderness →	DNA: 4 / Poor		Scan: 1.1 / Tender +					
WR	105	HerdBuilder Index: 53	Pct.: 55%		ProS: 102	Pct.: 34%				
YR	104	★★★★★ for Low Maintenance, Growth, Gainability, Marbling, Superior Cow, Calving Ease.								
Udder	Very Good									
Wean Pct.	52%									
Cow Eff.	109									

**9** **BSF Ranger K404 N7**   
 1-B 100% # 4675321 Tat: BSF2 K404

Birth: 3-27-22  
 Beckton Ranger B006 D5 < Beckton Ranger Z225 J4  
 Beckton Ranger G299 N6 < Beckton Suffeina Z731 D  
 Ref. R-1 < Beckton Nebula A773 L4  
 Beckton Indigo C018 N < Beckton Indigo A849 N  
 Beckton Nebula EN S347 < Beckton Nebula E P084  
 Beckton Rose C767 N < Beckton Eola P530 NB  
 Beckton Rose W816 C < BKT Clifftop TP R288  
 Beckton Rose S487 LN

BWt	73
WR	120
YWt.	1105
YR	111
FebADG	2.91
Frame	5.5
Feet	Good

DAM		Calv.Ease	BW	WW	YW	Milk	HPG	Stay	Maint.En.	
Age	7	EPDs	16	-3.7	63	103	32	12	17	-3.0
Wt	1270	Marb	+.42		REA	+.05		Bfat	+.06	
Prog. BW	67	Beef Tenderness →	DNA: 10 / Outstanding		Scan: 2.3 / Tender					
WR	105	HerdBuilder Index: 78	Pct.: 12%		ProS: 112	Pct.: 21%				
YR	98	★★★★★ for Low Maintenance, Growth, Marbling, Calving Ease.								
Udder	NA									
Wean Pct.	46%									
Cow Eff.	97									

**11** **BSF Ranger K361 J7**   
 1-B 99% # 4676361 Tat: BSF2 K361

Birth: 3-24-22  
 Beckton Ranger B006 D5 < Beckton Ranger Z225 J4  
 Beckton Ranger G299 N6 < Beckton Suffeina Z731 D  
 Ref. R-1 < Beckton Nebula A773 L4  
 Beckton Indigo C018 N < Beckton Indigo A849 N  
 Beckton Julian X721 E6 < Beckton Julian U699 L5  
 BSF Justicia Z119 J < Beckton Lana U329 EP  
 BSF Justicia X113 J < Beckton Jet U473 L2  
 BSF Justicia U855 JC

BWt	65
WR	111
YWt.	1063
YR	107
FebADG	3.06
Frame	5.5
Feet	Good

DAM		Calv.Ease	BW	WW	YW	Milk	HPG	Stay	Maint.En.	
Age	10	EPDs	18	-4.3	61	101	34	12	18	1.0
Wt	1075	Marb	+.44		REA	+.11		Bfat	+.05	
Prog. BW	69	Beef Tenderness →	DNA: 8 / Very Good		Scan: 1.7 / Tender					
WR	117	HerdBuilder Index: 82	Pct.: 8%		ProS: 120	Pct.: 13%				
YR	102	★★★★★ for Growth, Marbling, Superior Cow, Calving Ease.								
Udder	Fair									
Wean Pct.	50%									
Cow Eff.	106									

\*Note: Scrotal and ultrasound data will be available later

# 12

## Beckton Julian K838 N8

1-A 100% # 4675343 Tat: BKT2 K838



Birth: 5-1-22

Beckton Julian D551 C6  
**Beckton Julian F067 L7**  
 Ref. J-4  
 Beckton Indigo D786 L  
 Beckton Nebula A773 L4  
**Beckton Pine Marie C072 N**  
 Beckton Pine Marie A513 A

Beckton Julian X465 J5  
 Beckton Tamara W550 A  
 Beckton Likable Z057 L4  
 Beckton Indigo Y026 N  
 Beckton Nebula T398 V3  
 Beckton Mona X022 L  
 Beckton Accent U777 C2  
 BKT Pine Marie X424 H

BWt 82  
 WR 114  
 YWt. 1160  
 YR 115  
 FebADG 3.63  
 Frame 5.5  
 Feet Good

DAM		Calv.Ease	BW	WW	YW	Milk	HPG	Stay	Maint.En.	
Age	7	EPDs	14	-2.0	66	123	27	14	18	9.0
Wt	995	Marb	+0.36		REA	+1.0		Bfat	+0.03	
Prog. BW	69	Beef Tenderness	→		DNA	NA / NA		Scan	2.4 / Tender	
WR	106	HerdBuilder Index	61	Pct.	38%		ProS	120	Pct.: 12%	
YR	105	★★★★★ for Growth, Gainability, Marbling, Superior Cow, Calving Ease.								
Udder	Very Good									
Wean Pct.	54%									
Cow Eff.	113									



Lot 12

# 14

## Beckton Scamp K698 A7

1-A 100% # 4675553 Tat: BKT2 K698



Birth: 4-16-22

Beckton Scamp D325 N5  
**Beckton Scamp G236 L6**  
 Ref. S-3  
 Beckton Indigo Y406 L  
 Beckton Accent A175 03  
**Beckton Indigo E653 A**  
 Beckton Indigo A297 S

Beckton Scamp A627 J4  
 Beckton Tamara Y039 N  
 Beckton Likable U130 L2  
 Beckton Indigo R745 WR  
 Beckton Accent W180 C2  
 Beckton Lana R214 RA  
 Beckton Scamp T A825  
 Beckton Indigo W772 N

BWt 62  
 WR 106  
 YWt. 1106  
 YR 110  
 FebADG 3.91  
 Frame 5.5  
 Feet Good

DAM		Calv.Ease	BW	WW	YW	Milk	HPG	Stay	Maint.En.	
Age	5	EPDs	19	-5.4	64	106	30	10	15	-1.0
Wt	1190	Marb	+0.28		REA	+1.7		Bfat	+0.02	
Prog. BW	60	Beef Tenderness	→		DNA	10 / Outstanding		Scan	1.6 / Tender +	
WR	101	HerdBuilder Index	59	Pct.	42%		ProS	102	Pct.: 34%	
YR	106	★★★★★ for Low Maintenance, Growth, Gainability, Marbling, Rib-eye area, Calving Ease.								
Udder	NA									
Wean Pct.	42%									
Cow Eff.	88									

# 15

## BSF Dominor K322 N9

1-B 99% # 4676459 Tat: BSF2 K322



Birth: 3-22-22

Beckton Dominor A378 W7  
**Beckton Dominor F263 N8**  
 Ref. D-1  
 Beckton Larkaba W272 N  
 Beckton New Era A409 N2  
**BSF Epiquette C255 N**  
 BSF Epiquette Z961 A

Beckton Dominor Y005 V6  
 Beckton Lana Y541 W  
 Beckton Nebula EN S347  
 Beckton Larkaba N643 HR  
 Beckton New Era Y194  
 Beckton Eola W796 N  
 Beckton Accent U777 C2  
 BSF Epiquette U279 CT

BWt 85  
 WR 118  
 YWt. 1102  
 YR 111  
 FebADG 2.47  
 Frame 4.5  
 Feet Good

DAM		Calv.Ease	BW	WW	YW	Milk	HPG	Stay	Maint.En.	
Age	7	EPDs	15	-0.8	64	103	37	13	17	6.0
Wt	1160	Marb	+0.38		REA	+1.3		Bfat	+0.05	
Prog. BW	75	Beef Tenderness	→		DNA	9 / Outstanding		Scan	1.7 / Tender	
WR	117	HerdBuilder Index	67	Pct.	28%		ProS	96	Pct.: 44%	
YR	107	★★★★★ for Growth, Marbling, Rib-eye area, Superior Cow, Calving Ease.								
Udder	Very Good									
Wean Pct.	50%									
Cow Eff.	104									



Lot 15

# 13

## BSF Warrior K108 N8

1-B 99% # 4676333 Tat: BSF2 K108



Birth: 2-28-22

Beckton Warrior D359 L6  
**Beckton Warrior G356 N7**  
 Ref. W-1  
 Beckton Larkaba B277 N  
 Beckton Nebula T398 V3  
**BSF Helena X529 N**  
 BSF Helena T014 JD

Beckton Warrior Y108 E5  
 Beckton Lana W463 L  
 Beckton New Era Y194  
 Beckton Larkaba U062 CB  
 Beckton Nebula L P093  
 Beckton Minerva J615 VG  
 TR Julian RT561  
 BSF Helena R016 CQ

BWt 74  
 WR 87  
 YWt. 1125  
 YR 95  
 FebADG 3.22  
 Frame 5.0  
 Feet Good

DAM		Calv.Ease	BW	WW	YW	Milk	HPG	Stay	Maint.En.	
Age	12	EPDs	15	-3.2	50	85	24	12	19	0.0
Wt	1220	Marb	+0.25		REA	-0.23		Bfat	+0.03	
Prog. BW	72	Beef Tenderness	→		DNA	8 / Very Good		Scan	1.4 / Tender +	
WR	97	HerdBuilder Index	74	Pct.	17%		ProS	107	Pct.: 27%	
YR	99	★★★★★ for Low Maintenance, Marbling, Calving Ease.								
Udder	Very Good									
Wean Pct.	35%									
Cow Eff.	74									

\*Note: Scrotal and ultrasound data will be available later



## 16 BSF Warrior K320 E8

1-B 99% # 4676633 Tat: BSF2 K320



Birth: 3-21-22  
 Beckton Warrior D359 L6 < Beckton Warrior Y108 E5  
 Beckton Lana W463 L  
**Beckton Warrior G356 N7**  
 Ref. W-1 < Beckton Larkaba B277 N < Beckton New Era Y194  
 Beckton Larkaba U062 CB  
**BSF Lanette E831 E**  
 < Beckton Epic C776 J6 < Beckton Epic X464 L5  
 Beckton Sierra Y058 J  
 < Beckton Scamp X458 H3  
 BSF Lanette X568 W

BWt	82
WR	105
YWt.	1088
YR	109
FebADG	3.25
Frame	5.0
Feet	Good

DAM		Calv.Ease	BW	WW	YW	Milk	HPG	Stay	Maint.En.	
Age	5	EPDs	15	-2.7	63	105	31	NA	16	1.0
Wt	1030	Marb	+0.24		REA	+0.11		Bfat	+0.03	
Prog. BW	74	Beef Tenderness →	DNA: 10 / Outstanding		Scan:	1.7 / Tender				
WR	111	HerdBuilder Index:	58	Pct.: 45%	ProS:	91	Pct.: 53%			
YR	107	★★★★★ for Growth, Marbling, Superior Cow, Calving Ease.								
Udder	Very Good									
Wean Pct.	50%									
Cow Eff.	104									



Lot 16

## 18 Beckton Cardinal K396 L3

1-A 100% # 4675447 Tat: BKT2 K396



Birth: 3-27-22  
 Beckton Cardinal E673 L < TR Double Eagle ZT220  
 Beckton Larkaba A911 L  
**Beckton Cardinal G043 C2**  
 Ref. C-2 < Beckton Minerva E181 D < TR Double Eagle ZT220  
 Beckton Minerva W901 J  
 Beckton Likable X445 J3  
**Beckton Larkeisa D242 L**  
 < Beckton Likable Z057 L4 < Beckton Minola X107 L  
 Beckton Hasten H S462  
 BKT Larkeisa U535 HS < BKT Larkeisa S637 HS

BWt	80
WR	118
YWt.	1127
YR	113
FebADG	3.49
Frame	5.5
Feet	Good

DAM		Calv.Ease	BW	WW	YW	Milk	HPG	Stay	Maint.En.	
Age	6	EPDs	16	-3.0	71	118	27	13	16	5.0
Wt	1085	Marb	+0.36		REA	+0.34		Bfat	+0.03	
Prog. BW	64	Beef Tenderness →	DNA: 7 / Very Good		Scan:	1.8 / Tender				
WR	97	HerdBuilder Index:	59	Pct.: 42%	ProS:	101	Pct.: 37%			
YR	100	★★★★★ for Growth, Marbling, Rib-eye area, Calving Ease.								
Udder	Very Good									
Wean Pct.	53%									
Cow Eff.	111									

## 19 Beckton Julian K154 H9

1-A 100% # 4676281 Tat: BKT2 K154



Birth: 3-7-22  
 Beckton Julian F067 L7 < Beckton Julian D551 C6  
 Beckton Indigo D786 L  
**Beckton Julian H042 S8**  
 Ref. J-7 < Beckton Indigo F643 S < Beckton Scamp B720 L4  
 Beckton Indigo A849 N  
 Beckton Heritage B612 J4  
**Beckton Lana H031 H**  
 < Beckton Heritage F615 L5 < Beckton Mona X022 L  
 Beckton Likable D432 N3  
 Beckton Lana D429 L

BWt	60
WR	113
YWt.	1118
YR	114
FebADG	4.22
Frame	5.5
Feet	Good

DAM		Calv.Ease	BW	WW	YW	Milk	HPG	Stay	Maint.En.	
Age	2	EPDs	16	-3.4	69	123	27	NA	17	8.0
Wt	780	Marb	+0.50		REA	+0.15		Bfat	+0.04	
Prog. BW	60	Beef Tenderness →	DNA: 9 / Outstanding		Scan:	2.3 / Tender				
WR	113	HerdBuilder Index:	61	Pct.: 38%	ProS:	128	Pct.: 8%			
YR	114	★★★★★ for Growth, Gainability, Marbling, Rib-eye area, Superior Cow, Cow Efficiency, Calving Ease.								
Udder	Very Good									
Wean Pct.	58%									
Cow Eff.	121									

## 17 BSF Hughes K824 W4

1-B 99% # 4676627 Tat: BSF2 K824



Birth: 4-30-22  
 Beckton Hughes D589 S2 < Bieber H Hughes W109  
 Beckton Sierra Z353 S  
**Beckton Hughes F076 H3**  
 Ref. B-1 < Beckton Emera D487 B < Bieber H Hughes W109  
 Beckton Emera A186 A  
 Beckton Warrior Y108 E5  
**BSF Codette E051 W**  
 < Beckton Warrior C237 H6 < Beckton Christy T749 HT  
 Beckton Nebula X096 N4  
 BSF Codette Z044 N

BWt	76
WR	122
YWt.	1151
YR	116
FebADG	3.53
Frame	5.0
Feet	Good

DAM		Calv.Ease	BW	WW	YW	Milk	HPG	Stay	Maint.En.	
Age	5	EPDs	16	-2.8	66	108	30	NA	18	9.0
Wt	1065	Marb	+0.32		REA	-0.02		Bfat	+0.03	
Prog. BW	72	Beef Tenderness →	DNA: 9 / Outstanding		Scan:	1.7 / Tender				
WR	112	HerdBuilder Index:	75	Pct.: 15%	ProS:	108	Pct.: 26%			
YR	106	★★★★★ for Growth, Gainability, Marbling, Superior Cow, Cow Efficiency, Calving Ease.								
Udder	Very Good									
Wean Pct.	55%									
Cow Eff.	117									

## 20 Beckton Accent K469 L5

1-A 100% # 4676961 Tat: BSF2 K469



Birth: 3-30-22  
 Beckton Accent B549 N3 < Beckton Accent W180 C2  
 Beckton Minerva Y654 N  
**Beckton Accent H410 A4**  
 Ref. A-9 < Beckton Minola C198 A < Beckton Accent A485 C3  
 Beckton Minola A330 S  
 Beckton Likable U130 L2  
**Beckton Firefly H257 L**  
 < Beckton Likable D432 N3 < Beckton Firefly W013 N  
 Beckton Accent W180 C2  
 Beckton Firefly U409 JD

BWt	70
WR	120
YWt.	1108
YR	113
FebADG	3.75
Frame	6.0
Feet	Good

DAM		Calv.Ease	BW	WW	YW	Milk	HPG	Stay	Maint.En.	
Age	2	EPDs	15	-2.2	71	115	29	NA	18	4.0
Wt	835	Marb	+0.26		REA	+0.31		Bfat	+0.03	
Prog. BW	70	Beef Tenderness →	DNA: 7 / Very Good		Scan:	1.6 / Tender +				
WR	113	HerdBuilder Index:	79	Pct.: 11%	ProS:	96	Pct.: 43%			
YR	120	★★★★★ for Growth, Gainability, Marbling, Rib-eye area, Superior Cow, Cow Efficiency, Calving Ease.								
Udder	Very Good									
Wean Pct.	58%									
Cow Eff.	122									

\*Note: Scrotal and ultrasound data will be available later

**21****Beckton Accent K186 D6**

1-A 100% # 4676273 Tat: BKT2 K186



Birth: 3-10-22	Beckton Accent F363 L4	Beckton Accent B549 N3	
	Beckton Coca B062 L		
<b>Beckton Accent H121 H5</b>	Beckton Heritage B612 J4		
Ref. A-8	Beckton Christy Z229 N		
	Beckton Dominor F263 N8	Beckton Dominor A378 W7	
<b>Beckton Lana H043 D</b>	Beckton Larkaba W272 N		
	Beckton Likable D432 N3		
	Beckton Lana F092 L	Beckton Lana D796 L	

BWt	56
WR	112
YWt.	1120
YR	114
FebADG	4.10
Frame	5.5
Feet	Good

<b>DAM</b>	Age	2	Calv.Ease	BW	WW	YW	Milk	HPG	Stay	Maint.En.	
	Wt	800	EPDs	19	-3.9	63	106	33	NA	14	1.0
	Prog. BW	56	Marb	+3.6		REA	+1.5		Bfat	+0.5	
	WR	112	Beef Tenderness	→		DNA: 9 / Outstanding	Scan: 1.7 / Tender				
	YR	114	HerdBuilder Index:	64	Pct.: 32%	ProS:	106	Pct.: 29%			
	Udder	Very Good	★★★★★ for Growth, Gainability, Marbling, Rib-eye area, Superior Cow, Cow Efficiency, Calving Ease.								
	Wean Pct.	56%									
	Cow Eff.	117									

**24****Beckton Likable K505 H4**

1-A 100% # 4675967 Tat: BKT2 K505



Birth: 4-1-22	Beckton Likable U130 L2	Beckton Likable S633	
	Beckton Kit S478 LN		
<b>Beckton Likable C229 R3</b>	Beckton Roman J S158		
Ref. L-2	Beckton Tamara X447 J	Beckton Tamara R834 JC	
	Beckton Hughes E113 S3	Beckton Hughes C350 N2	
<b>Beckton Minola G055 H</b>	Beckton Lana C003 S		
	Beckton Dominor A378 W7	Beckton Minola B538 E	

BWt	79
WR	121
YWt.	1127
YR	115
FebADG	3.71
Frame	5.5
Feet	Good

<b>DAM</b>	Age	3	Calv.Ease	BW	WW	YW	Milk	HPG	Stay	Maint.En.	
	Wt	810	EPDs	12	1.6	78	125	28	12	15	0.0
	Prog. BW	76	Marb	+2.8		REA	+2.7		Bfat	+0.3	
	WR	121	Beef Tenderness	→		DNA: 9 / Outstanding	Scan: 1.6 / Tender +				
	YR	115	HerdBuilder Index:	59	Pct.: 43%	ProS:	83	Pct.: 65%			
	Udder	Very Good	★★★★★ for Low Maintenance, Growth, Gainability, Marbling, Rib-eye area, Superior Cow, Cow Efficiency, Calving Ease.								
	Wean Pct.	61%									
	Cow Eff.	129									

**22****Beckton Likable K114 H6**

1-A 100% # 4676947 Tat: BSF2 K114



Birth: 3-2-22	Beckton Likable E391 N4	Beckton Likable Y124 L3	
	Beckton Lana X466 N		
<b>Beckton Likable H518 N5</b>	Beckton Nebula T398 V3		
Ref. L-7	Beckton Serena X338 N	Beckton Serena S649 LO	
	Beckton Hughes C463 N2	Bieber H Hughes W109	
<b>Beckton Angel H328 H</b>	Beckton Lakme T689 NX		
	Beckton Cody K1 P014	Beckton Angel H164 LO	

BWt	69
WR	113
YWt.	1029
YR	105
FebADG	3.46
Frame	5.5
Feet	Good

<b>DAM</b>	Age	2	Calv.Ease	BW	WW	YW	Milk	HPG	Stay	Maint.En.	
	Wt	870	EPDs	12	-0.6	72	112	27	12	20	5.0
	Prog. BW	69	Marb	+3.7		REA	+0.3		Bfat	+0.3	
	WR	113	Beef Tenderness	→		DNA: 7 / Very Good	Scan: 1.3 / Tender +				
	YR	105	HerdBuilder Index:	87	Pct.: 5%	ProS:	111	Pct.: 22%			
	Udder	Very Good	★★★★★ for Marbling, Superior Cow, Calving Ease.								
	Wean Pct.	52%									
	Cow Eff.	109									

**25****Beckton Nebula K421 W5**

1-A 100% # 4675241 Tat: BKT2 K421



Birth: 3-28-22	Beckton Nebula T398 V3	Beckton Nebula L P093	
	Beckton Minerva J615 VG		
<b>Beckton Nebula A773 L4</b>	Beckton Likable U130 L2		
Ref. N-2	Beckton Mona X022 L	Beckton Mona U584 CD	
	Beckton Warrior Y108 E5	Beckton Warrior W534 N4	
<b>Beckton Minola A873 W</b>	Beckton Susan W058 E		
	Beckton Nebula U206 V3	Beckton Minola R720 JJ	

BWt	69
WR	98
YWt.	1097
YR	110
FebADG	3.59
Frame	5.5
Feet	Good

<b>DAM</b>	Age	9	Calv.Ease	BW	WW	YW	Milk	HPG	Stay	Maint.En.	
	Wt	1020	EPDs	16	-4.9	60	102	29	14	21	1.0
	Prog. BW	63	Marb	+2.6		REA	-0.8		Bfat	+0.4	
	WR	104	Beef Tenderness	→		DNA: 9 / Outstanding	Scan: 1.6 / Tender +				
	YR	106	HerdBuilder Index:	92	Pct.: 3%	ProS:	134	Pct.: 5%			
	Udder	Very Good	★★★★★ for Growth, Gainability, Marbling, Superior Cow, Calving Ease.								
	Wean Pct.	47%									
	Cow Eff.	98									

**23****WCRA Likable K201**

B 99% # 4659649 Tat: WCRA2K201



Birth: 3-16-22	Beckton Likable Z057 L4	Beckton Likable X445 J3	
	Beckton Minola X107 L		
<b>Beckton Likable B032 C5</b>	Beckton Clifftop W577 E3		
Ref. L-1	Beckton Mona Z270 C	Beckton Mona U584 CD	
	Beckton Scamp B720 L4	Beckton Scamp X458 H3	
<b>BSF Nebulann E272 S</b>	Beckton Larkaba Y448 L		
	Beckton Loki Y448 L	Beckton Nebulann X393 N	

BWt	80
WR	107
YWt.	1023
YR	111
FebADG	3.84
Frame	5.5
Feet	Good

<b>DAM</b>	Age	5	Calv.Ease	BW	WW	YW	Milk	HPG	Stay	Maint.En.	
	Wt	1245	EPDs	15	-3.3	62	118	23	12	12	18.0
	Prog. BW	83	Marb	+4.9		REA	+0.5		Bfat	+0.3	
	WR	101	Beef Tenderness	→		DNA: NA / NA	Scan: 2.5 / Tender				
	YR	105	HerdBuilder Index:	10	Pct.: 99%	ProS:	81	Pct.: 69%			
	Udder	Very Good	★★★★★ for Growth, Gainability, Marbling, Calving Ease.								
	Wean Pct.	43%									
	Cow Eff.	NA									



Lot 23

\*Note: Scrotal and ultrasound data will be available later

## 26 Beckton Accent K490 H4

1-A 100% # 4675651 Tat: BKT2 K490



Birth: 3-31-22

Beckton Accent B740 W3  
 Ref. A-3

Beckton Emera F625 H

Beckton Cody K1 P014  
 Beckton Christy R046 CQ  
 Beckton Warrior W534 N4  
 Beckton Lana W370 E  
 Bieber H Hughes W109  
 Beckton Lakme T689 NX  
 Beckton Clifftop Z824 C4  
 Beckton Emera Z775 C

BWt	73
WR	118
YWt.	1131
YR	113
FebADG	3.59
Frame	6.0
Feet	Good

DAM	
Age	4
Wt	1075
Prog. BW	62
WR	110
YR	110
Udder	Very Good
Wean Pct.	52%
Cow Eff.	108

Calv.Ease	BW	WW	YW	Milk	HPG	Stay	Maint.En.	
EPDs	17	-3.3	73	116	27	11	18	5.0
Marb	+0.37		REA	+0.04		Bfat		+0.04
Beef Tenderness	→		DNA: 9 / Outstanding	Scan: 1.9 / Tender				
HerdBuilder Index:	76	Pct.: 13%	ProS: 103		Pct.: 33%			

★★★★★ for Growth, Gainability, Marbling, Superior Cow, Calving Ease.

## 29 Beckton Accent K456 L4

1-A 100% # 4675395 Tat: BKT2 K456



Birth: 3-30-22

Beckton Accent F602 L3  
 Ref. A-4

Beckton Susan D621 L

Beckton Cody K1 P014  
 Beckton Christy R046 CQ  
 Beckton Likable U130 L2  
 Beckton Lana Y541 W  
 Beckton Likable U130 L2  
 BKT Pine Marie S802 L0  
 Beckton Likable U120 L2  
 Beckton Susan N023 JE

BWt	57
WR	107
YWt.	1002
YR	101
FebADG	2.92
Frame	5.5
Feet	Good

DAM	
Age	6
Wt	970
Prog. BW	56
WR	103
YR	103
Udder	Very Good
Wean Pct.	53%
Cow Eff.	113

Calv.Ease	BW	WW	YW	Milk	HPG	Stay	Maint.En.	
EPDs	21	-6.3	56	90	28	13	20	-4.0
Marb	+0.31		REA	+0.22		Bfat		+0.03
Beef Tenderness	→		DNA: 10 / Outstanding	Scan: 1.6 / Tender +				
HerdBuilder Index:	104	Pct.: 1%	ProS: 128		Pct.: 7%			

★★★★★ for Low Maintenance, Marbling, Rib-eye area, Calving Ease.

## 27 Beckton Likable K673 E4

1-A 100% # 4675565 Tat: BKT2 K673



Birth: 4-14-22

Beckton Likable C229 R3  
 Ref. L-2

Beckton Sheba E355 E

Beckton Likable U130 L2  
 Beckton Kit S478 LN  
 Beckton Roman J S158  
 Beckton Tamara R834 JC  
 Beckton Epic Y484 N6  
 Beckton Larkaba Y648 E  
 Beckton Julian X465 J5  
 Beckton Sheba P631 JC

BWt	89
WR	124
YWt.	1210
YR	121
FebADG	4.60
Frame	5.5
Feet	Good

DAM	
Age	5
Wt	1020
Prog. BW	72
WR	115
YR	111
Udder	Fair
Wean Pct.	59%
Cow Eff.	125

Calv.Ease	BW	WW	YW	Milk	HPG	Stay	Maint.En.	
EPDs	10	0.5	78	128	26	11	14	3.0
Marb	+0.49		REA	+0.36		Bfat		+0.03
Beef Tenderness	→		DNA: 10 / Outstanding	Scan: 1.7 / Tender				
HerdBuilder Index:	38	Pct.: 82%	ProS: 92		Pct.: 51%			

★★★★★ for Growth, Gainability, Marbling, Rib-eye area, Superior Cow, Cow Efficiency.



Lot 29

## 28 Beckton Accent K400 W4

1-A 100% # 4676541 Tat: BSF2 K400



Birth: 3-27-22

Beckton Accent B549 N3  
 Ref. A-2

Beckton Encino D840 W

Beckton Cody K1 P014  
 Beckton Christy R046 CQ  
 Beckton Nebula T398 V3  
 Beckton Minerva M369 L0  
 Beckton Warrior W534 N4  
 Beckton Susan W058 E  
 Beckton Cody K1 P014  
 Beckton Encino R488 JL

BWt	70
WR	112
YWt.	1090
YR	109
FebADG	3.40
Frame	5.5
Feet	Good

DAM	
Age	6
Wt	1190
Prog. BW	63
WR	107
YR	105
Udder	Very Good
Wean Pct.	46%
Cow Eff.	97

Calv.Ease	BW	WW	YW	Milk	HPG	Stay	Maint.En.	
EPDs	16	-3.9	66	109	26	13	15	12.0
Marb	+0.34		REA	+0.05		Bfat		+0.04
Beef Tenderness	→		DNA: 9 / Outstanding	Scan: 1.9 / Tender				
HerdBuilder Index:	46	Pct.: 68%	ProS: 76		Pct.: 76%			

★★★★★ for Growth, Marbling, Superior Cow, Calving Ease.

## 30 Beckton Cardinal K266 H2

1-A 100% # 4675747 Tat: BKT2 K266



Birth: 3-18-22

Beckton Cardinal E673 L  
 Ref. C-1

Beckton Indigo F114 H

TR Double Eagle ZT220  
 Beckton Lana U182 JC  
 Beckton Legend U331 E2  
 Beckton Larkaba T418 WA  
 Beckton Heritage A767 C3  
 Beckton Susan W846 L  
 Beckton Nebula A773 L4  
 Beckton Indigo A849 N

BWt	64
WR	113
YWt.	1033
YR	104
FebADG	2.83
Frame	5.0
Feet	Good

DAM	
Age	4
Wt	895
Prog. BW	66
WR	103
YR	113
Udder	Very Good
Wean Pct.	59%
Cow Eff.	125

Calv.Ease	BW	WW	YW	Milk	HPG	Stay	Maint.En.	
EPDs	19	-5.6	65	104	30	10	20	5.0
Marb	+0.48		REA	+0.11		Bfat		+0.04
Beef Tenderness	→		DNA: 9 / Outstanding	Scan: 1.9 / Tender				
HerdBuilder Index:	79	Pct.: 11%	ProS: 117		Pct.: 15%			

★★★★★ for Marbling, Cow Efficiency, Calving Ease.

\*Note: Scrotal and ultrasound data will be available later

# 31

## Beckton Likable K176 L7

1-A 100% # 4675181 Tat: BKT2 K176



Birth: 3-9-22	Beckton Likable B032 C5	Beckton Likable Z057 L4	BWt	65
	Beckton Larkaba X064 J	Beckton Mona Z270 C	WR	110
<b>Beckton Likable F287 J6</b>		Beckton Julian U699 L5	YWt.	1072
Ref. L-4		Beckton Larkaba U475 CT	YR	106
	Beckton Likable X445 J3	Beckton Likable U130 L2	FebADG	3.43
<b>BKT Pine Marie Z194 L</b>		Beckton Indigo U658 JL	Frame	5.0
	BKT Pine Marie X339 N	Beckton Nebula T269 E2	Feet	Good
		BKT Pine Marie S467 JE		

<b>DAM</b>	Calv.Ease	BW	WW	YW	Milk	HPG	Stay	Maint.En.
Age	10							
Wt	1030	EPDs	15	-4.3	59	100	28	13
Prog. BW	73	Marb	+4.8		REA	-1.0		Bfat
WR	110	Beef Tenderness →	DNA: 9 / Outstanding		Scan:	1.8 / Tender		
YR	106	HerdBuilder Index:	59	Pct.: 42%	ProS:	93	Pct.: 48%	
Udder	Very Good	★★★★★ for Low Maintenance, Growth, Marbling, Superior Cow, Calving Ease.						
Wean Pct.	50%							
Cow Eff.	105							



Lot 31

# 33

## Beckton Scamp K246 L6

1-A 100% # 4676345 Tat: BSF2 K246



Birth: 3-17-22	Beckton Scamp B720 L4	Beckton Scamp X458 H3	BWt	69
	Beckton Belga W103 N	Beckton Larkaba Y448 L	WR	103
<b>Beckton Scamp E175 N5</b>		Beckton Nebula T398 V3	YWt.	1071
Ref. S-1		Beckton Belga T551 EP	YR	108
	Beckton Likable U120 L2	Beckton Likable S633	FebADG	3.24
<b>Beckton Coca Y399 L</b>		Beckton Lana S718 LN	Frame	5.0
	Beckton Coca H051 CH	Beckton Champ RH F275	Feet	Good
		Beckton Coca F048 LN		

<b>DAM</b>	Calv.Ease	BW	WW	YW	Milk	HPG	Stay	Maint.En.
Age	11							
Wt	900	EPDs	18	-4.7	49	85	29	8
Prog. BW	66	Marb	+3.8		REA	+0.0		Bfat
WR	104	Beef Tenderness →	DNA: 10 / Outstanding		Scan:	2.1 / Tender		
YR	102	HerdBuilder Index:	67	Pct.: 27%	ProS:	112	Pct.: 21%	
Udder	Very Good	★★★★★ for Low Maintenance, Growth, Marbling, Calving Ease.						
Wean Pct.	54%							
Cow Eff.	113							

# 34

## Beckton Cardinal K446 A2

1-A 100% # 4675559 Tat: BKT2 K446



Birth: 3-29-22	TR Double Eagle ZT220	TR Ricardo DOS	BWt	81
	Beckton Larkaba A911 L	Beckton Lana U182 JC	WR	104
<b>Beckton Cardinal E673 L</b>		Beckton Legend U331 E2	YWt.	1037
Ref. C-1		Beckton Larkaba T418 WA	YR	99
	Beckton Accent W180 C2	Beckton Cody K1 P014	FebADG	2.73
<b>Beckton Emera E160 A</b>		Beckton Christy R046 CQ	Frame	5.5
	Beckton Emera A029 D	Beckton Dominor Y005 V6	Feet	Good
		Beckton Emera Y009 D		

<b>DAM</b>	Calv.Ease	BW	WW	YW	Milk	HPG	Stay	Maint.En.
Age	5							
Wt	1000	EPDs	19	-5.4	61	95	27	13
Prog. BW	67	Marb	+4.7		REA	+1.4		Bfat
WR	102	Beef Tenderness →	DNA: 7 / Very Good		Scan:	1.9 / Tender		
YR	98	HerdBuilder Index:	94	Pct.: 2%	ProS:	130	Pct.: 6%	
Udder	Very Good	★★★★★ for Low Maintenance, Marbling, Rib-eye area, Cow Efficiency, Calving Ease.						
Wean Pct.	58%							
Cow Eff.	122							



Lot 34

# 32

## Beckton Nebula K360 S5

1-A 100% # 4675267 Tat: BKT2 K360



Birth: 3-24-22	Beckton Nebula T398 V3	Beckton Nebula L P093	BWt	77
	Beckton Mona X022 L	Beckton Minerva J615 VG	WR	107
<b>Beckton Nebula A773 L4</b>		Beckton Likable U130 L2	YWt.	1016
Ref. N-2		Beckton Mona U584 CD	YR	101
	Beckton Scamp X494 E3	Beckton Scamp T A825	FebADG	3.33
<b>Beckton Tamara B253 S</b>		Beckton Lana S074 EP	Frame	5.0
	Beckton Tamara X587 J	Beckton Julian U699 L5	Feet	Good
		Beckton Tamara S432 DM		

<b>DAM</b>	Calv.Ease	BW	WW	YW	Milk	HPG	Stay	Maint.En.
Age	8							
Wt	1030	EPDs	12	-2.4	59	92	31	14
Prog. BW	67	Marb	+3.2		REA	-0.3		Bfat
WR	105	Beef Tenderness →	DNA: 7 / Very Good		Scan:	1.3 / Tender +		
YR	104	HerdBuilder Index:	96	Pct.: 2%	ProS:	118	Pct.: 14%	
Udder	Very Good	★★★★★ for Low Maintenance, Marbling, Superior Cow, Calving Ease.						
Wean Pct.	49%							
Cow Eff.	103							

\*Note: Scrotal and ultrasound data will be available later

## 35 Beckton Epic K182 L9

1-A 100% # 4676055 Tat: BKT2 K182

Birth: 3-10-22

Beckton Epic H312 A8  
Ref. E-2

Beckton Lana H637 L

Beckton Epic D001 L7

Beckton Larkaba B352 A

Beckton Epic B483 N6

Beckton Mona B713 L

Beckton Accent Y260 L3

Beckton Larkaba Y156 N

Beckton Likable Y124 L3

Beckton Lana X466 N

Beckton Likable B032 C5

Beckton Lana B153 A

BWt 71

WR 111

YWt. 1052

YR 107

FebADG 3.71

Frame 5.5

Feet Good

DAM		Calv.Ease	BW	WW	YW	Milk	HPG	Stay	Maint.En.	
Age	2	EPDs	12	-1.4	68	113	29	NA	20	13.0
Wt	870	Marb	+0.46		REA	-0.02		Bfat	+0.05	
Prog. BW	71	Beef Tenderness	→		DNA	7 / Very Good		Scan	1.6 / Tender +	
WR	111	HerdBuilder Index	69	Pct.	24%	ProS	107	Pct.	27%	
YR	107	★★★★★ for Growth, Gainability, Marbling, Superior Cow, Calving Ease.								
Udder	Very Good									
Wean Pct.	51%									
Cow Eff.	107									

## 38 Beckton Oracle K382 N3

1-A 100% # 4675245 Tat: BKT2 K382

Birth: 3-26-22

Beckton Oracle G222 J2  
Ref. O-4

Beckton Susan B246 N

Schuler Oracle-7142E

Beckton Rose E470 J

Beckton New Era Y194

Beckton Susan R022 CQ

Schuler Sudden Impact 0004X

Sor Marlee Cmmtmnt 0470X

Beckton Julian GG B571

Beckton Rose W346 E

Beckton Nebula P P707

BKT Larkeisa T310 JC

Beckton Cherokee N N479

Beckton Susan N023 JE

BWt 68

WR 109

YWt. 1004

YR 101

FebADG 2.83

Frame 5.0

Feet Good

DAM		Calv.Ease	BW	WW	YW	Milk	HPG	Stay	Maint.En.	
Age	8	EPDs	21	-7.1	57	88	28	13	18	2.0
Wt	1110	Marb	+0.54		REA	+0.09		Bfat	+0.04	
Prog. BW	60	Beef Tenderness	→		DNA	10 / Outstanding		Scan	2.0 / Tender	
WR	101	HerdBuilder Index	78	Pct.	11%	ProS	122	Pct.	11%	
YR	106	★★★★★ for Marbling, Calving Ease.								
Udder	Very Good									
Wean Pct.	48%									
Cow Eff.	101									

## 36 Beckton Accent K512 J2

1-A 100% # 4675269 Tat: BKT2 K512

Birth: 4-1-22

Beckton Accent W180 C2  
Ref. A-1

Beckton Coca B785 J

Beckton Cody K1 P014

Beckton Christy R046 CQ

Beckton Cody KH M390

Beckton Rose M126 WR

Beckton Cherokee N N479

Beckton Christy N740 HR

Beckton Julian 7526G

Bkt Marta 9A13 JL

Beckton Nebula T398 V3

Beckton Coca P602 JL

BWt 71

WR 106

YWt. 1018

YR 102

FebADG 3.30

Frame 5.0

Feet Good

DAM		Calv.Ease	BW	WW	YW	Milk	HPG	Stay	Maint.En.	
Age	8	EPDs	17	-4.2	60	94	27	15	21	-5.0
Wt	1130	Marb	+0.37		REA	+0.02		Bfat	+0.04	
Prog. BW	72	Beef Tenderness	→		DNA	9 / Outstanding		Scan	1.6 / Tender +	
WR	103	HerdBuilder Index	105	Pct.	1%	ProS	128	Pct.	8%	
YR	106	★★★★★ for Low Maintenance, Marbling, Calving Ease.								
Udder	Very Good									
Wean Pct.	46%									
Cow Eff.	96									

## 39 Beckton Scamp K202 N6

1-A 100% # 4676355 Tat: BSF2 K202

Birth: 3-12-22

Beckton Scamp E175 N5  
Ref. S-1

Beckton Larkaba Y156 N

Beckton Scamp B720 L4

Beckton Belga W103 N

Beckton Nebula T398 V3

Beckton Larkaba U274 JL

Beckton Scamp X458 H3

Beckton Larkaba Y448 L

Beckton Nebula T398 V3

Beckton Belga T551 EP

Beckton Nebula L P093

Beckton Minerva J615 VG

Beckton Julian G3 P608

Beckton Larkaba N708 HR

BWt 62

WR 112

YWt. 1015

YR 102

FebADG 3.14

Frame 5.0

Feet Good

DAM		Calv.Ease	BW	WW	YW	Milk	HPG	Stay	Maint.En.	
Age	11	EPDs	19	-6.0	54	90	29	12	20	3.0
Wt	1240	Marb	+0.38		REA	-0.07		Bfat	+0.04	
Prog. BW	69	Beef Tenderness	→		DNA	10 / Outstanding		Scan	2.3 / Tender	
WR	103	HerdBuilder Index	83	Pct.	7%	ProS	112	Pct.	21%	
YR	102	★★★★★ for Marbling, Calving Ease.								
Udder	Good									
Wean Pct.	42%									
Cow Eff.	89									

## 37 Beckton Scamp K124 D7

1-A 100% # 4676295 Tat: BKT2 K124

Birth: 3-3-22

Beckton Scamp H076 E6  
Ref. S-4

Beckton Lana H011 D

Beckton Scamp F172 N5

Beckton Larkaba F349 E

Beckton Scamp B720 L4

Beckton Angel X450 N

Beckton Epic B310 J6

Beckton Larkaba B409 L

Beckton Dominor D254 N8

Beckton Larkaba D014 A

Beckton Accent D174 N3

Beckton Lana D445 A

BWt 67

WR 120

YWt. 1066

YR 108

FebADG 3.46

Frame 5.5

Feet Good

DAM		Calv.Ease	BW	WW	YW	Milk	HPG	Stay	Maint.En.	
Age	2	EPDs	16	-1.9	72	112	31	NA	17	7.0
Wt	895	Marb	+0.32		REA	+0.14		Bfat	+0.04	
Prog. BW	67	Beef Tenderness	→		DNA	10 / Outstanding		Scan	1.6 / Tender +	
WR	120	HerdBuilder Index	71	Pct.	20%	ProS	92	Pct.	51%	
YR	108	★★★★★ for Growth, Marbling, Rib-eye area, Superior Cow, Calving Ease.								
Udder	Very Good									
Wean Pct.	54%									
Cow Eff.	113									

## 40 BSF Likable K443 L6

1-B 99% # 4676847 Tat: BSF2 K443

Birth: 3-29-22

Beckton Likable F520 N5  
Ref. L

BSF Epiquette G077 L

Beckton Likable Z057 L4

Beckton Sierra A836 N

Beckton Legend E032 E3

BSF Epiquette E681 A

Beckton Likable X445 J3

Beckton Minola X107 L

Beckton New Era Y194

Beckton Sierra S847 WR

Beckton Legend C313 C2

Beckton Emera C066 E

Beckton Accent W180 C2

BSF Epiquette B051 E

BWt 71

WR 121

YWt. 1146

YR 117

FebADG 3.38

Frame 5.5

Feet Good

DAM		Calv.Ease	BW	WW	YW	Milk	HPG	Stay	Maint.En.	
Age	3	EPDs	11	-1.0	73	123	23	13	14	4.0
Wt	1000	Marb	+0.42		REA	+0.20		Bfat	+0.03	
Prog. BW	71	Beef Tenderness	→		DNA	7 / Very Good		Scan	2.0 / Tender	
WR	121	HerdBuilder Index	39	Pct.	80%	ProS	85	Pct.	62%	
YR	117	★★★★★ for Growth, Marbling, Rib-eye area, Superior Cow.								
Udder	Very Good									
Wean Pct.	49%									
Cow Eff.	104									

\*Note: Scrotal and ultrasound data will be available later

**41****BSF Epic K233 L9**

1-B 99% # 4676987 Tat: BSF2 K233



Birth: 3-15-22	Beckton Epic D001 L7	Beckton Epic B483 N6	BWt	55
		Beckton Mona B713 L	WR	119
<b>Beckton Epic H312 A8</b>	Beckton Larkaba B352 A	Beckton Accent Y260 L3	YWt.	1111
Ref. E-2		Beckton Larkaba Y156 N	YR	113
	Beckton Likable F816 A4	Beckton Likable B509 J3	FebADG	2.72
<b>BSF Hustelle H157 L</b>	Beckton Barmmaid B366 A	Beckton Roosevelt D391 L2	Frame	5.5
	BSF Hustelle F214 R	BSF Hustelle B134 E	Feet	Good

<b>DAM</b>	Calv.Ease	BW	WW	YW	Milk	HPG	Stay	Maint.En.
Age	2							
Wt	820	EPDs	14	-2.4	72	118	33	NA 18 7.0
Prog. BW	55	Marb	+.42		REA	+.12		Bfat
WR	119	Beef Tenderness	→ DNA: 10 / Outstanding		Scan	2.2 / Tender		
YR	113	HerdBuilder Index:	72	Pct.: 19%	ProS:	107	Pct.: 27%	
Udder	Very Good	★★★★★ for Growth, Marbling, Superior Cow, Cow Efficiency, Calving Ease.						
Wean Pct.	58%							
Cow Eff.	122							

**44****Beckton Dominor K509 E9**

1-A 100% # 4676679 Tat: BSF2 K509



Birth: 4-1-22	Beckton Dominor A378 W7	Beckton Dominor Y005 V6	BWt	65
		Beckton Lana Y541 W	WR	102
<b>Beckton Dominor F263 N8</b>	Beckton Larkaba W272 N	Beckton Nebula EN S347	YWt.	1095
Ref. D-1		Beckton Larkaba N643 HR	YR	110
	Beckton Epic D457 C7	Beckton Epic Z674 E6	FebADG	3.56
<b>Beckton Barmmaid F515 E</b>	Beckton Mona Z270 C	Beckton Accent U777 C2	Frame	5.5
	Beckton Barmmaid D653 A	Beckton Barmmaid A410 J	Feet	Good

<b>DAM</b>	Calv.Ease	BW	WW	YW	Milk	HPG	Stay	Maint.En.
Age	4							
Wt	1000	EPDs	20	-4.7	56	96	32	14 15 0.0
Prog. BW	60	Marb	+.42		REA	+.12		Bfat
WR	100	Beef Tenderness	→ DNA: 10 / Outstanding		Scan	1.4 / Tender +		
YR	101	HerdBuilder Index:	64	Pct.: 33%	ProS:	109	Pct.: 25%	
Udder	Very Good	★★★★★ for Low Maintenance, Growth, Gainability, Marbling, Calving Ease.						
Wean Pct.	47%							
Cow Eff.	100							

**42****BSF Warrior K778 R8**

1-B 99% # 4676739 Tat: BSF2 K778



Birth: 4-25-22	Beckton Warrior D359 L6	Beckton Warrior Y108 E5	BWt	80
		Beckton Lana W463 L	WR	110
<b>Beckton Warrior G356 N7</b>	Beckton Larkaba B277 N	Beckton New Era Y194	YWt.	1163
Ref. W-1		Beckton Larkaba U062 CB	YR	117
	Beckton Roosevelt D305 C2	Bieber Roosevelt W384	FebADG	3.78
<b>BSF Julianne F120 R</b>	Beckton Lana W277 A	Beckton Likable B154 W4	Frame	5.5
	BSF Julianne D131 L	BSF Julianne B007 M8	Feet	Good

<b>DAM</b>	Calv.Ease	BW	WW	YW	Milk	HPG	Stay	Maint.En.
Age	4							
Wt	1050	EPDs	15	-2.0	64	107	28	12 17 2.0
Prog. BW	67	Marb	+.29		REA	+.03		Bfat
WR	107	Beef Tenderness	→ DNA: 7 / Very Good		Scan	2.0 / Tender		
YR	109	HerdBuilder Index:	61	Pct.: 39%	ProS:	106	Pct.: 28%	
Udder	Very Good	★★★★★ for Growth, Gainability, Marbling, Superior Cow, Calving Ease.						
Wean Pct.	49%							
Cow Eff.	103							



Lot 44

**43****BSF Scamp K191 N7**

1-B 99% # 4676403 Tat: BSF2 K191



Birth: 3-11-22	Beckton Scamp E175 N5	Beckton Scamp B720 L4	BWt	52
		Beckton Belga W103 N	WR	92
<b>Beckton Scamp G006 C6</b>	Beckton Firefly E769 C	Beckton Cardinal B074 N	YWt.	1028
Ref. S-2		Beckton Firefly B052 W	YR	102
	Beckton Nebula Y002 C5	Beckton Nebula W778 J4	FebADG	3.50
<b>BSF Dominique A092 N</b>	BKT Pine Marie W102 C	Beckton Accent W180 C2	Frame	5.0
	BSF Dominique Y109 A	BSF Dominique W352 J	Feet	Good

<b>DAM</b>	Calv.Ease	BW	WW	YW	Milk	HPG	Stay	Maint.En.
Age	9							
Wt	1070	EPDs	22	-8.5	54	96	23	NA 20 6.0
Prog. BW	65	Marb	+.37		REA	-.06		Bfat
WR	95	Beef Tenderness	→ DNA: 10 / Outstanding		Scan	2.1 / Tender		
YR	99	HerdBuilder Index:	82	Pct.: 8%	ProS:	131	Pct.: 6%	
Udder	Very Good	★★★★★ for Gainability, Marbling, Calving Ease.						
Wean Pct.	40%							
Cow Eff.	85							

**45****Beckton Oracle K130 H3**

1-A 100% # 4676085 Tat: BKT2 K130



Birth: 3-4-22	Schuler Oracle-7142E	Schuler Sudden Impact 0004X	BWt	56
		Sor Marlee Cmmtmnt 0470X	WR	102
<b>Beckton Oracle H376 A2</b>	Beckton Minerva A683 A	Beckton Accent W180 C2	YWt.	1076
Ref. 0		Beckton Minerva L324 LN	YR	109
	Beckton Heritage C477 J4	Beckton Heritage X403 L3	FebADG	3.75
<b>Beckton Christy H570 H</b>	Beckton Ruth Z858 J	Beckton Epic A587 N7	Frame	5.5
	Beckton Christy E626 E	Beckton Christy T749 HT	Feet	Good

<b>DAM</b>	Calv.Ease	BW	WW	YW	Milk	HPG	Stay	Maint.En.
Age	2							
Wt	765	EPDs	15	-2.7	66	114	26	NA 17 3.0
Prog. BW	56	Marb	+.47		REA	+.24		Bfat
WR	102	Beef Tenderness	→ DNA: 10 / Outstanding		Scan	1.6 / Tender +		
YR	109	HerdBuilder Index:	68	Pct.: 26%	ProS:	126	Pct.: 8%	
Udder	Good	★★★★★ for Growth, Gainability, Marbling, Rib-eye area, Calving Ease.						
Wean Pct.	52%							
Cow Eff.	109							

\*Note: Scrotal and ultrasound data will be available later

## 46 Beckton Nebula K583 A5

1-A 100% # 4675173 Tat: BKT2 K583

Birth: 4-6-22

Beckton Nebula B557 J3

**Beckton Nebula G249 N4**

Ref. N-4

Beckton Lana Y130 N

Beckton Accent U777 C2

**Beckton Susan Z770 A**

Beckton Susan W058 E

Beckton Nebula P P707

Beckton Larkaba T813 JC

Beckton Nebula W022 D3

Beckton Lana W525 D

Beckton Cody K1 P014

Beckton Susan R022 CQ

Beckton Epic T330 L5

Beckton Susan T048 NB

BWt **74**

WR **104**

YWt. **1081**

YR **107**

FebADG **3.34**

Frame **5.0**

Feet **Good**

DAM		Calv.Ease	BW	WW	YW	Milk	HPG	Stay	Maint.En.	
Age	10	EPDs	16	-4.3	53	99	35	14	16	5.0
Wt	1120	Marb	+51		REA	+04		Bfat	+05	
Prog. BW	66	Beef Tenderness →	DNA: 9 / Outstanding		Scan:	1.6 / Tender +				
WR	106	HerdBuilder Index:	59	Pct.: 42%	ProS:	118	Pct.: 15%			
YR	104	★★★★★ for Growth, Marbling, Superior Cow, Calving Ease.								
Udder	Very Good									
Wean Pct.	43%									
Cow Eff.	91									

## 49 Beckton Likable K667 E7

1-A 100% # 4675681 Tat: BKT2 K667

Birth: 4-13-22

Beckton Likable B032 C5

**Beckton Likable F287 J6**

Ref. L-4

Beckton Larkaba X064 J

Beckton Epic B310 J6

**Beckton Larkaba F405 E**

Beckton Larkaba Y083 N

Beckton Likable Z057 L4

Beckton Mona Z270 C

Beckton Julian U699 L5

Beckton Larkaba U475 CT

Beckton Epic X464 L5

Beckton Minerva Y116 J

Beckton Nebula W130 D3

Beckton Larkaba W264 W

BWt **61**

WR **100**

YWt. **1100**

YR **110**

FebADG **4.06**

Frame **5.5**

Feet **Good**

DAM		Calv.Ease	BW	WW	YW	Milk	HPG	Stay	Maint.En.	
Age	4	EPDs	17	-4.7	60	106	26	13	15	3.0
Wt	940	Marb	+50		REA	+01		Bfat	+05	
Prog. BW	61	Beef Tenderness →	DNA: 9 / Outstanding		Scan:	2.6 / Tender -				
WR	103	HerdBuilder Index:	58	Pct.: 45%	ProS:	119	Pct.: 14%			
YR	106	★★★★★ for Growth, Gainability, Marbling, Superior Cow, Calving Ease.								
Udder	Very Good									
Wean Pct.	50%									
Cow Eff.	104									

## 47 Beckton Warrior K782 D8

1-A 100% # 4675575 Tat: BKT2 K782

Birth: 4-25-22

Beckton Warrior D359 L6

**Beckton Warrior G356 N7**

Ref. W-1

Beckton Larkaba B277 N

TR Double Eagle ZT220

**Beckton Susan E418 D**

Beckton Susan B120 L

Beckton Warrior Y108 E5

Beckton Lana W463 L

Beckton New Era Y194

Beckton Larkaba U062 CB

TR Ricardo DOS

Beckton Lana U182 JC

Beckton Legend Z689 J3

Beckton Susan Z427 L

BWt **81**

WR **113**

YWt. **1114**

YR **111**

FebADG **3.47**

Frame **5.5**

Feet **Good**

DAM		Calv.Ease	BW	WW	YW	Milk	HPG	Stay	Maint.En.	
Age	5	EPDs	13	-1.3	68	110	31	12	15	1.0
Wt	1050	Marb	+35		REA	+19		Bfat	+03	
Prog. BW	61	Beef Tenderness →	DNA: 10 / Outstanding		Scan:	1.7 / Tender				
WR	106	HerdBuilder Index:	49	Pct.: 64%	ProS:	92	Pct.: 50%			
YR	100	★★★★★ for Growth, Marbling, Rib-eye area, Calving Ease.								
Udder	Very Good									
Wean Pct.	50%									
Cow Eff.	106									

## 50 Beckton Likable K379 A5

1-A 100% # 4676443 Tat: BSF2 K379

Birth: 3-26-22

Beckton Likable C229 R3

**Beckton Likable G403 N4**

Ref. L-6

Beckton Minerva Y385 N

Beckton Accent W180 C2

**Beckton Minerva B452 A**

Beckton Minerva Y520 J

Beckton Likable U130 L2

Beckton Tamara X447 J

Beckton Nebula T398 V3

Beckton Minerva U310 L0

Beckton Cody K1 P014

Beckton Christy R046 CQ

Beckton Julian U742 W5

Beckton Minerva U586 CT

BWt **62**

WR **109**

YWt. **1041**

YR **104**

FebADG **3.56**

Frame **5.0**

Feet **Good**

DAM		Calv.Ease	BW	WW	YW	Milk	HPG	Stay	Maint.En.	
Age	8	EPDs	19	-6.2	58	92	27	12	21	-3.0
Wt	1120	Marb	+38		REA	+11		Bfat	+04	
Prog. BW	72	Beef Tenderness →	DNA: 9 / Outstanding		Scan:	1.6 / Tender +				
WR	103	HerdBuilder Index:	97	Pct.: 2%	ProS:	125	Pct.: 9%			
YR	104	★★★★★ for Low Maintenance, Gainability, Marbling, Superior Cow, Calving Ease.								
Udder	Very Good									
Wean Pct.	48%									
Cow Eff.	100									

## 48 Beckton Likable K284 A6

1-A 100% # 4675587 Tat: BKT2 K284

Birth: 3-19-22

Beckton Likable Z057 L4

**Beckton Likable G289 J5**

Ref. L-5

Beckton Coca B785 J

Beckton Accent C557 N4

**Beckton Lana E097 A**

Beckton Lana C471 N

Beckton Likable X445 J3

Beckton Minola X107 L

Beckton Julian GG B571

Beckton Coca X787 N

Beckton Accent Y312 N3

Beckton Minerva Y654 N

Beckton New Era Y194

Beckton Lana W019 H

BWt **56**

WR **91**

YWt. **1027**

YR **103**

FebADG **3.91**

Frame **5.0**

Feet **Good**

DAM		Calv.Ease	BW	WW	YW	Milk	HPG	Stay	Maint.En.	
Age	5	EPDs	18	-5.6	56	98	26	12	17	0.0
Wt	920	Marb	+54		REA	-02		Bfat	+05	
Prog. BW	55	Beef Tenderness →	DNA: 10 / Outstanding		Scan:	1.5 / Tender +				
WR	101	HerdBuilder Index:	58	Pct.: 45%	ProS:	129	Pct.: 7%			
YR	108	★★★★★ for Low Maintenance, Gainability, Marbling, Calving Ease.								
Udder	Very Good									
Wean Pct.	48%									
Cow Eff.	101									

## 51 Beckton Julian K440 A8

1-A 100% # 4676533 Tat: BSF2 K440

Birth: 3-29-22

Beckton Julian D551 C6

**Beckton Julian F067 L7**

Ref. J-4

Beckton Indigo D786 L

Beckton Accent Y260 L3

**Beckton Barmaid D218 A**

Beckton Barmaid P323 HR

Beckton Julian X465 J5

Beckton Tamara W550 A

Beckton Likable Z057 L4

Beckton Indigo Y026 N

Beckton Accent W180 C2

Beckton Lana W463 L

Beckton Herald FV J537

Beckton Barmaid J012 CO

BWt **79**

WR **117**

YWt. **1099**

YR **110**

FebADG **3.27**

Frame **5.0**

Feet **Good**

DAM		Calv.Ease	BW	WW	YW	Milk	HPG	Stay	Maint.En.	
Age	6	EPDs	15	-2.4	61	109	29	13	17	8.0
Wt	1055	Marb	+55		REA	-05		Bfat	+05	
Prog. BW	70	Beef Tenderness →	DNA: 7 / Very Good		Scan:	1.8 / Tender				
WR	114	HerdBuilder Index:	50	Pct.: 62%	ProS:	105	Pct.: 29%			
YR	111	★★★★★ for Growth, Marbling, Superior Cow, Calving Ease.								
Udder	Very Good									
Wean Pct.	54%									
Cow Eff.	113									

\*Note: Scrotal and ultrasound data will be available later

## 52 Beckton Cardinal K636 D2

1-A 100% # 4675531 Tat: BKT2 K636

Birth: 4-10-22

**Beckton Cardinal E673 L**  
Ref. C-1

**Beckton Minerva E287 D**

TR Double Eagle ZT220  
Beckton Larkaba A911 L

TR Ricardo DOS  
Beckton Lana U182 JC  
Beckton Legend U331 E2  
Beckton Larkaba T418 WA

TR Ricardo DOS  
Beckton Lana U182 JC  
Beckton Julian W743 H5  
Beckton Minerva W081 N



BWt **68**  
WR **104**  
YWt. **1042**  
YR **105**  
FebADG **3.30**  
Frame **5.0**  
Feet **Good**

DAM		Calv.Ease	BW	WW	YW	Milk	HPG	Stay	Maint.En.	
Age	5	EPDs	21	-5.3	60	103	30	13	19	0.0
Wt	1140	Marb	+4.8		REA +2.7		Bfat +.03			
Prog. BW	60	Beef Tenderness	→		DNA: 7 / Very Good		Scan: 1.5 / Tender +			
WR	90	HerdBuilder Index	87	Pct.: 5%	ProS: 140		Pct.: 3%			
YR	102	★★★★★ for Low Maintenance, Marbling, Rib-eye area, Calving Ease.								
Udder	Good									
Wean Pct.	45%									
Cow Eff.	94									

## 55 Beckton Legend K496 L5

1-A 100% # 4675631 Tat: BKT2 K496

Birth: 4-1-22

**Beckton Legend E464 L4**  
Ref. L

**Beckton Coca F798 L**

Beckton Legend Z689 J3  
Beckton Ucola X143 L

Beckton Legend X561 J2  
Beckton Larkaba W868 J  
Beckton Likable U120 L2  
Beckton Ucola U709 L0  
Beckton Likable U130 L2  
Beckton Coca T363 JL  
Beckton Legend Z689 J3  
Beckton Coca Z239 N



BWt **69**  
WR **110**  
YWt. **1029**  
YR **103**  
FebADG **2.98**  
Frame **5.0**  
Feet **Good**

DAM		Calv.Ease	BW	WW	YW	Milk	HPG	Stay	Maint.En.	
Age	4	EPDs	15	-2.0	63	95	29	NA	16	5.0
Wt	975	Marb	+3.2		REA +.24		Bfat +.02			
Prog. BW	65	Beef Tenderness	→		DNA: 10 / Outstanding		Scan: 1.4 / Tender +			
WR	109	HerdBuilder Index	65	Pct.: 32%	ProS: 79		Pct.: 71%			
YR	102	★★★★★ for Marbling, Rib-eye area, Calving Ease.								
Udder	Very Good									
Wean Pct.	53%									
Cow Eff.	111									

## 53 Beckton Oracle K126 L3

1-A 100% # 4676177 Tat: BKT2 K126

Birth: 3-3-22

**Beckton Oracle H390 L2**  
Ref. 0-5

**Beckton Lana H256 L**

Schuler Oracle-7142E  
Sor Marlee Cmmtmnt 0470X

Beckton Legend S670  
Beckton Lana T348 NB

Beckton Likable B032 C5  
Beckton Firefly Z112 L

Beckton Heritage B612 J4  
Beckton Lana Z276 W



BWt **56**  
WR **110**  
YWt. **1078**  
YR **110**  
FebADG **3.81**  
Frame **5.0**  
Feet **Good**

DAM		Calv.Ease	BW	WW	YW	Milk	HPG	Stay	Maint.En.	
Age	2	EPDs	17	-4.7	64	112	27	NA	14	6.0
Wt	815	Marb	+4.3		REA +.15		Bfat +.03			
Prog. BW	56	Beef Tenderness	→		DNA: 9 / Outstanding		Scan: 1.4 / Tender +			
WR	110	HerdBuilder Index	51	Pct.: 59%	ProS: 103		Pct.: 32%			
YR	110	★★★★★ for Growth, Gainability, Marbling, Rib-eye area, Superior Cow, Calving Ease.								
Udder	Very Good									
Wean Pct.	53%									
Cow Eff.	112									

## 56 BSF Likable K767 L4

1-B 99% # 4676763 Tat: BSF2 K767

Birth: 4-23-22

**Beckton Likable C229 R3**  
Ref. L-2

**BSF Justicia G581 L**

Beckton Likable U130 L2  
Beckton Tamara X447 J

Beckton Likable S633  
Beckton Kit S478 LN  
Beckton Roman J S158  
Beckton Tamara R834 JC  
Beckton Likable X445 J3  
Beckton Minola X107 L  
Beckton Hasten U108 J3  
BSF Justicia U290 JC



BWt **66**  
WR **113**  
YWt. **1168**  
YR **119**  
FebADG **4.41**  
Frame **5.5**  
Feet **Good**

DAM		Calv.Ease	BW	WW	YW	Milk	HPG	Stay	Maint.En.	
Age	3	EPDs	13	-2.0	69	115	27	13	15	3.0
Wt	995	Marb	+4.4		REA +.23		Bfat +.03			
Prog. BW	66	Beef Tenderness	→		DNA: 9 / Outstanding		Scan: 1.9 / Tender			
WR	113	HerdBuilder Index	47	Pct.: 66%	ProS: 86		Pct.: 61%			
YR	119	★★★★★ for Growth, Gainability, Marbling, Rib-eye area, Superior Cow, Calving Ease.								
Udder	Very Good									
Wean Pct.	49%									
Cow Eff.	103									

## 54 Beckton Cardinal K534 A2

1-A 100% # 4675427 Tat: BKT2 K532

Birth: 4-3-22

**Beckton Cardinal E673 L**  
Ref. C-1

**Beckton Tamara D561 A**

TR Double Eagle ZT220  
Beckton Larkaba A911 L

TR Ricardo DOS  
Beckton Lana U182 JC  
Beckton Legend U331 E2  
Beckton Larkaba T418 WA

Beckton Cody K1 P014  
Beckton Susan R022 CQ  
Beckton Cherokee N N479  
Beckton Tamara N765 CO



BWt **68**  
WR **118**  
YWt. **1093**  
YR **108**  
FebADG **2.83**  
Frame **4.5**  
Feet **Good**

DAM		Calv.Ease	BW	WW	YW	Milk	HPG	Stay	Maint.En.	
Age	6	EPDs	20	-5.3	67	105	31	14	19	1.0
Wt	1120	Marb	+5.0		REA +.20		Bfat +.05			
Prog. BW	67	Beef Tenderness	→		DNA: 7 / Very Good		Scan: 2.5 / Tender			
WR	102	HerdBuilder Index	86	Pct.: 5%	ProS: 117		Pct.: 15%			
YR	100	★★★★★ for Growth, Marbling, Rib-eye area, Calving Ease.								
Udder	Good									
Wean Pct.	49%									
Cow Eff.	103									

## 57 Beckton Oracle K067 L3

1-A 100% # 4676257 Tat: BKT2 K067

Birth: 2-20-22

**Beckton Oracle H390 L2**  
Ref. 0-5

**Beckton Firefly H083 L**

Schuler Oracle-7142E  
Beckton Lana D222 L

Schuler Sudden Impact 0004X  
Sor Marlee Cmmtmnt 0470X  
Beckton Legend S670  
Beckton Lana T348 NB  
Beckton Likable Y124 L3  
Beckton Firefly A022 D  
Beckton Scamp D325 N5  
Beckton Firefly C265 N



BWt **59**  
WR **110**  
YWt. **1071**  
YR **111**  
FebADG **3.53**  
Frame **5.0**  
Feet **Good**

DAM		Calv.Ease	BW	WW	YW	Milk	HPG	Stay	Maint.En.	
Age	2	EPDs	18	-4.1	68	117	27	NA	16	2.0
Wt	805	Marb	+5.1		REA +.19		Bfat +.04			
Prog. BW	59	Beef Tenderness	→		DNA: NA / NA		Scan: 0.8 / Tender +			
WR	110	HerdBuilder Index	68	Pct.: 25%	ProS: 127		Pct.: 8%			
YR	111	★★★★★ for Growth, Gainability, Marbling, Rib-eye area, Superior Cow, Calving Ease.								
Udder	Very Good									
Wean Pct.	50%									
Cow Eff.	105									

\*Note: Scrotal and ultrasound data will be available later



**58** **BSF Jet K431 W3** 

1-B 99% # 4676625 Tat: BSF2 K431

Birth: 3-29-22

Beckton Jet L P491 < TR Julian Lt151  
 Beckton Minerva L278 LN

**Beckton Jet G441 N2**  
 Ref. J-5 Beckton Susan B246 N < Beckton New Era Y194  
 Beckton Susan R022 CQ

Beckton Warrior C695 W6 < Beckton Warrior Y108 E5  
 Beckton Lana Y033 W

**BSF Hustelle E198 W**  
 BSF Hustelle C558 N < Beckton Nebula W778 J4  
 BSF Hustelle Z850 S

BWt	60
WR	113
YWt.	1080
YR	108
FebADG	NA
Frame	5.0
Feet	Good

DAM	
Age	5
Wt	1010
Prog. BW	64
WR	114
YR	113
Udder	Good
Wean Pct.	54%
Cow Eff.	114

Calv.Ease	BW	WW	YW	Milk	HPG	Stay	Maint.En.	
EPDs	21	-7.7	57	90	32	12	15	1.0
Marb	+4.6		REA	-1.2		Bfat		+0.3
Beef Tenderness	→ DNA: 9 / Outstanding		Scan: 2.5 / Tender					
HerdBuilder Index:	59	Pct.: 42%	ProS: 90		Pct.: 54%			

★★★★★ for Growth, Marbling, Superior Cow, Calving Ease.



Lot 58

**59** **Beckton Cardinal K101 C3** 

1-A 100% # 4676155 Tat: BKT2 K101

Birth: 2-27-22

Beckton Cardinal E673 L < TR Double Eagle ZT220  
 Beckton Larkaba A911 L

**Beckton Cardinal H671 E2**  
 Ref. C-3 Beckton Tamara B700 E < Beckton Epic X464 L5  
 Beckton Tamara Y585 N

Beckton Cardinal E673 L < TR Double Eagle ZT220  
 Beckton Larkaba A911 L

**Beckton Indigo H350 C**  
 Beckton Indigo A297 S < Beckton Scamp T A825  
 Beckton Indigo W772 N

BWt	74
WR	109
YWt.	1091
YR	113
FebADG	4.00
Frame	5.0
Feet	Good

DAM	
Age	2
Wt	850
Prog. BW	74
WR	109
YR	113
Udder	NA
Wean Pct.	47%
Cow Eff.	99

Calv.Ease	BW	WW	YW	Milk	HPG	Stay	Maint.En.	
EPDs	16	-2.5	72	123	30	NA	18	4.0
Marb	+4.8		REA	+2.3		Bfat		+0.05
Beef Tenderness	→ DNA: 7 / Very Good		Scan: 1.2 / Tender +					
HerdBuilder Index:	75	Pct.: 15%	ProS: 135		Pct.: 4%			

★★★★★ for Growth, Gainability, Marbling, Rib-eye area, Superior Cow, Calving Ease.

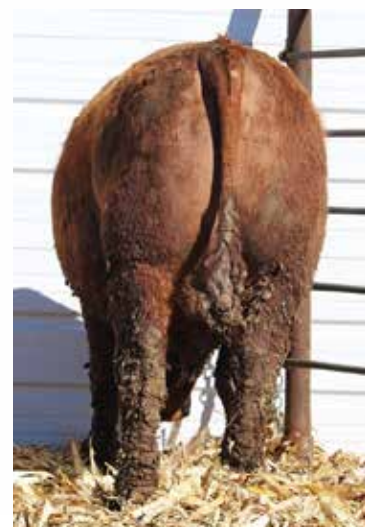

Lot 59



Lot 59

**60** **BSF Julian K773 E8** 

1-B 99% # 4676643 Tat: BSF2 K773

Birth: 4-24-22

Beckton Julian D551 C6 < Beckton Julian X465 J5  
 Beckton Tamara W550 A

**Beckton Julian F067 L7**  
 Ref. J-4 Beckton Indigo D786 L < Beckton Likable Z057 L4  
 Beckton Indigo Y026 N

Beckton Epic C776 J6 < Beckton Epic X464 L5  
 Beckton Sierra Y058 J

**BSF Cliftana E126 E**  
 BSF Cliftana C120 N < Beckton Nebula A773 L4  
 BSF Cliftana A563 L

BWt	67
WR	104
YWt.	1103
YR	111
FebADG	4.19
Frame	5.0
Feet	Good

DAM	
Age	5
Wt	985
Prog. BW	70
WR	109
YR	108
Udder	Very Good
Wean Pct.	51%
Cow Eff.	108

Calv.Ease	BW	WW	YW	Milk	HPG	Stay	Maint.En.	
EPDs	18	-3.9	62	114	29	13	15	8.0
Marb	+3.6		REA	+1.7		Bfat		+0.03
Beef Tenderness	→ DNA: 10 / Outstanding		Scan: 1.4 / Tender +					
HerdBuilder Index:	49	Pct.: 63%	ProS: 106		Pct.: 28%			

★★★★★ for Growth, Gainability, Marbling, Rib-eye area, Superior Cow, Calving Ease.

\*Note: Scrotal and ultrasound data will be available later

**61****Beckton Oracle K378 N3**

1-A 100% # 4676347 Tat: BSF2 K378



Birth: 3-26-22  
 Schuler Oracle-7142E < Schuler Sudden Impact 0004X  
 Sor Marlee Cmmmtnt 0470X  
**Beckton Oracle G222 J2**  
 Ref. 0-4 < Beckton Rose E470 J < Beckton Julian GG B571  
 Beckton Rose W346 E  
 Beckton Nebula T398 V3 < Beckton Nebula L P093  
**Beckton Indigo Y343 N** < Beckton Minerva J615 VG  
 Beckton Indigo H150 LN < Beckton Lancer TE F363  
 Beckton Indigo F376 CT

BWt **58**  
 WR **104**  
 YWt. **1033**  
 YR **102**  
 FebADG **2.91**  
 Frame **5.0**  
 Feet **Good**

DAM		Calv.Ease	BW	WW	YW	Milk	HPG	Stay	Maint.En.	
Age	11	EPDs	21	-7.2	50	82	28	12	20	1.0
Wt	1030	Marb	+5.5		REA		-0.6	Bfat		+0.4
Prog. BW	69	Beef Tenderness	→ DNA: 10 / Outstanding		Scan:		1.7 / Tender			
WR	104	HerdBuilder Index:	93	Pct.: 3%	ProS:		141	Pct.: 3%		
YR	104	★★★★★ for Marbling, Superior Cow, Calving Ease.								
Udder	Good									
Wean Pct.	45%									
Cow Eff.	95									

**64****Beckton Nebula K444 J5**

1-A 100% # 4676301 Tat: BSF2 K444



Birth: 3-29-22  
 Beckton Nebula B557 J3 < Beckton Nebula P P707  
 Beckton Larkaba T813 JC  
**Beckton Nebula G249 N4**  
 Ref. N-4 < Beckton Nebula W022 D3  
 Beckton Lana W525 D  
 Beckton Justice T124 C1 < Beckton Justice C1 R483  
**Beckton Barmaid W423 J** < Beckton Scarlett R808 NB  
 Beckton Barmaid G565 LN < Beckton Lancer T A664  
 Bkt Barmaid 9517 RN

BWt **69**  
 WR **99**  
 YWt. **1042**  
 YR **105**  
 FebADG **3.31**  
 Frame **5.0**  
 Feet **Good**

DAM		Calv.Ease	BW	WW	YW	Milk	HPG	Stay	Maint.En.	
Age	13	EPDs	17	-5.3	47	88	30	13	16	-2.0
Wt	1140	Marb	+4.8		REA		-0.9	Bfat		+0.3
Prog. BW	68	Beef Tenderness	→ DNA: 9 / Outstanding		Scan:		1.7 / Tender			
WR	101	HerdBuilder Index:	59	Pct.: 43%	ProS:		117	Pct.: 15%		
YR	109	★★★★★ for Low Maintenance, Marbling, Calving Ease.								
Udder	Fair									
Wean Pct.	41%									
Cow Eff.	85									

**62****Beckton Nebula K475 D5**

1-A 100% # 4676389 Tat: BSF2 K475



Birth: 3-31-22  
 Beckton Nebula B557 J3 < Beckton Nebula P P707  
 Beckton Larkaba T813 JC  
**Beckton Nebula G249 N4**  
 Ref. N-4 < Beckton Nebula W022 D3  
 Beckton Lana W525 D  
 Beckton Dominor W640 C5 < Beckton Dominor Z1 R610  
**Beckton Minerva A560 D** < Beckton Mona R166 CQ  
 Beckton Minerva U313 NB < Beckton Nebula PJ S543  
 Beckton Minerva S839 HW

BWt **76**  
 WR **100**  
 YWt. **1005**  
 YR **100**  
 FebADG **3.28**  
 Frame **5.0**  
 Feet **Good**

DAM		Calv.Ease	BW	WW	YW	Milk	HPG	Stay	Maint.En.	
Age	9	EPDs	15	-3.3	53	88	27	14	17	7.0
Wt	1180	Marb	+5.5		REA		-0.6	Bfat		+0.4
Prog. BW	70	Beef Tenderness	→ DNA: 9 / Outstanding		Scan:		1.6 / Tender +			
WR	102	HerdBuilder Index:	56	Pct.: 49%	ProS:		107	Pct.: 27%		
YR	99	★★★★★ for Marbling, Calving Ease.								
Udder	Very Good									
Wean Pct.	40%									
Cow Eff.	83									

**65****Beckton Nebula K429 D5**

1-A 100% # 4676373 Tat: BKT2 K429



Birth: 3-28-22  
 Beckton Nebula B557 J3 < Beckton Nebula P P707  
 Beckton Larkaba T813 JC  
**Beckton Nebula G249 N4**  
 Ref. N-4 < Beckton Nebula W022 D3  
 Beckton Lana W525 D  
 Beckton Dominor W640 C5 < Beckton Dominor Z1 R610  
**Beckton Coca Z639 D** < Beckton Mona R166 CQ  
 Beckton Coca T080 NB < Beckton Nebula N R573  
 Beckton Coca R375 WR

BWt **64**  
 WR **100**  
 YWt. **1015**  
 YR **101**  
 FebADG **3.00**  
 Frame **5.0**  
 Feet **Good**

DAM		Calv.Ease	BW	WW	YW	Milk	HPG	Stay	Maint.En.	
Age	10	EPDs	19	-6.0	52	92	26	13	16	0.0
Wt	1065	Marb	+5.4		REA		-1.3	Bfat		+0.5
Prog. BW	69	Beef Tenderness	→ DNA: 9 / Outstanding		Scan:		1.9 / Tender			
WR	103	HerdBuilder Index:	65	Pct.: 31%	ProS:		124	Pct.: 10%		
YR	106	★★★★★ for Low Maintenance, Marbling, Superior Cow, Calving Ease.								
Udder	Very Good									
Wean Pct.	44%									
Cow Eff.	93									

**63****Beckton Likable K839 N4**

1-A 100% # 4676305 Tat: BSF2 K839



Birth: 5-1-22  
 Beckton Likable U130 L2 < Beckton Likable S633  
 Beckton Kit S478 LN  
**Beckton Likable E636 C3**  
 Ref. L-3 < BKT Clifftop TP R288  
 Beckton Minola W808 C < Beckton Minola R604 CD  
 Beckton Nebula EN S347 < Beckton Nebula E P084  
**Beckton Lana W518 N** < Beckton Eola P530 NB  
 Beckton Lana P073 EP < Beckton Epic KM M115  
 Beckton Lana M393 LN

BWt **62**  
 WR **119**  
 YWt. **1115**  
 YR **111**  
 FebADG **3.16**  
 Frame **5.0**  
 Feet **Good**

DAM		Calv.Ease	BW	WW	YW	Milk	HPG	Stay	Maint.En.	
Age	13	EPDs	17	-5.4	59	91	38	13	17	-1.0
Wt	1150	Marb	+3.6		REA		+1.1	Bfat		+0.5
Prog. BW	65	Beef Tenderness	→ DNA: 7 / Very Good		Scan:		2.3 / Tender			
WR	111	HerdBuilder Index:	78	Pct.: 11%	ProS:		96	Pct.: 45%		
YR	108	★★★★★ for Low Maintenance, Growth, Marbling, Superior Cow, Calving Ease.								
Udder	Very Good									
Wean Pct.	47%									
Cow Eff.	98									

**66****Beckton Accent K338 A5**

1-A 100% # 4676713 Tat: BSF2 K338



Birth: 3-22-22  
 Beckton Accent E172 L3 < Beckton Accent W180 C2  
 Beckton Indigo Y406 L  
**Beckton Accent G107 C4**  
 Ref. A-5 < TR Double Eagle ZT220  
 Beckton Pine Marie E206 D < BKT Pine Marie W404 J  
 Beckton Accent B549 N3 < Beckton Accent W180 C2  
**Beckton Barmaid F268 A** < Beckton Minerva Y654 N  
 Beckton Barmaid C194 N < Beckton New Era Y194  
 Beckton Barmaid X654 N

BWt **60**  
 WR **96**  
 YWt. **1023**  
 YR **103**  
 FebADG **3.41**  
 Frame **5.0**  
 Feet **Good**

DAM		Calv.Ease	BW	WW	YW	Milk	HPG	Stay	Maint.En.	
Age	4	EPDs	18	-5.8	57	97	28	11	20	1.0
Wt	1065	Marb	+4.8		REA		+1.7	Bfat		+0.3
Prog. BW	58	Beef Tenderness	→ DNA: 9 / Outstanding		Scan:		1.5 / Tender +			
WR	99	HerdBuilder Index:	80	Pct.: 10%	ProS:		145	Pct.: 2%		
YR	93	★★★★★ for Marbling, Rib-eye area, Calving Ease.								
Udder	Very Good									
Wean Pct.	42%									
Cow Eff.	88									

\*Note: Scrotal and ultrasound data will be available later

## 67 Beckton Cardinal K721 E2

1-A 100% # 4676525 Tat: BSF2 K721

Birth: 4-18-22

TR Double Eagle ZT220  
 Beckton Cardinal E673 L  
 Ref. C-1  
 Beckton Larkaba A911 L

TR Ricardo DOS  
 Beckton Lana U182 JC  
 Beckton Legend U331 E2  
 Beckton Larkaba T418 WA  
 Beckton Epic Y484 N6  
 Beckton Serena X338 N  
 Beckton Epic B545 N7  
 Beckton Minerva D154 E  
 Beckton Minerva B452 A

BWt 57  
 WR 99  
 YWt. 1050  
 YR 105  
 FebADG 3.41  
 Frame 5.0  
 Feet Good

DAM		Calv.Ease	BW	WW	YW	Milk	HPG	Stay	Maint.En.	
Age	6	EPDs	20	-5.8	63	106	28	12	17	7.0
Wt	1140	Marb	+5.56		REA	+3.4		Bfat	+0.04	
Prog. BW	62	Beef Tenderness →	DNA: 7 / Very Good		Scan: 1.1 / Tender +					
WR	102	HerdBuilder Index: 64	Pct: 32%	ProS: 124	Pct: 9%					
YR	104	★★★★★ for Growth, Marbling, Rib-eye area, Calving Ease.								
Udder	Very Good									
Wean Pct.	42%									
Cow Eff.	89									

## 70 Beckton Lancer K472 D2

1-A 100% # 4675551 Tat: BKT2 K472

Birth: 3-30-22

Redhill 9B Lancer 11E  
 Ref. O-1  
 Redhill T189 Barmaid 190W

Buf Crk The Right Kind U199  
 Buf Crk Redpride P154  
 Buf Crk Nice N Easy T189  
 1BWJ Barmaid 54P  
 TR Ricardo DOS  
 Beckton Lana U182 JC  
 Beckton Accent U777 C2  
 Beckton Tamara W204 E

BWt 82  
 WR 110  
 YWt. 1040  
 YR 104  
 FebADG 2.83  
 Frame 5.5  
 Feet Good

DAM		Calv.Ease	BW	WW	YW	Milk	HPG	Stay	Maint.En.	
Age	5	EPDs	12	-1.8	63	96	32	13	17	6.0
Wt	1000	Marb	+4.6		REA	-.01		Bfat	+0.03	
Prog. BW	72	Beef Tenderness →	DNA: 7 / Very Good		Scan: 2.2 / Tender					
WR	108	HerdBuilder Index: 62	Pct: 36%	ProS: 92	Pct: 51%					
YR	104	★★★★★ for Marbling, Superior Cow, Calving Ease.								
Udder	Very Good									
Wean Pct.	54%									
Cow Eff.	113									

## 68 BSF Scamp K143 N6

1-B 99% # 4676573 Tat: BSF2 K143

Birth: 3-5-22

Beckton Scamp B720 L4  
 Beckton Scamp E175 N5  
 Ref. S-1  
 Beckton Belga W103 N

Beckton Scamp X458 H3  
 Beckton Larkaba Y448 L  
 Beckton Nebula T398 V3  
 Beckton Belga T551 EP  
 Beckton Nebula T269 E2  
 Beckton Indigo T613 JT  
 Beckton Nebula X267 J3  
 BSF Hustelle E785 N  
 BSF Hustelle U447 HH

BWt 57  
 WR 83  
 YWt. 986  
 YR 99  
 FebADG 3.53  
 Frame 5.0  
 Feet Good

DAM		Calv.Ease	BW	WW	YW	Milk	HPG	Stay	Maint.En.	
Age	5	EPDs	19	-7.3	43	81	26	10	17	-3.0
Wt	1015	Marb	+3.39		REA	-.15		Bfat	+0.04	
Prog. BW	57	Beef Tenderness →	DNA: 9 / Outstanding		Scan: 1.7 / Tender					
WR	93	HerdBuilder Index: 67	Pct: 27%	ProS: 110	Pct: 23%					
YR	92	★★★★★ for Low Maintenance, Gainability, Marbling, Calving Ease.								
Udder	Very Good									
Wean Pct.	40%									
Cow Eff.	84									

## 71 Beckton Accent K705 A3

1-A 100% # 4676501 Tat: BSF2 K705

Birth: 4-16-22

Beckton Cody K1 P014  
 Beckton Accent W180 C2  
 Ref. A-1  
 Beckton Christy R046 CQ

Beckton Cody KH M390  
 Beckton Rose M126 WR  
 Beckton Cherokee N N479  
 Beckton Christy N740 HR  
 Beckton Accent Y260 L3  
 Beckton Ruth Y015 E  
 Beckton Accent A110 E4  
 Beckton Larkabel C101 A  
 Beckton Larkabel A015 A

BWt 79  
 WR 111  
 YWt. 1028  
 YR 103  
 FebADG 3.14  
 Frame 5.0  
 Feet Good

DAM		Calv.Ease	BW	WW	YW	Milk	HPG	Stay	Maint.En.	
Age	7	EPDs	16	-2.6	63	96	28	14	22	-2.0
Wt	1045	Marb	+3.37		REA	-.04		Bfat	+0.04	
Prog. BW	69	Beef Tenderness →	DNA: 7 / Very Good		Scan: 1.9 / Tender					
WR	101	HerdBuilder Index: 104	Pct: 1%	ProS: 122	Pct: 11%					
YR	105	★★★★★ for Low Maintenance, Marbling, Calving Ease.								
Udder	Fair									
Wean Pct.	52%									
Cow Eff.	108									

## 69 WCRA Dominor K215

A 100% # 4659661 Tat: WCRA2K215

Birth: 5-1-22

Beckton Dominor D254 N8  
 Beckton Dominor H423 N9  
 Ref. D-4  
 Beckton Lana Y130 N

Beckton Dominor A378 W7  
 Beckton Indigo W772 N  
 Beckton Nebula W022 D3  
 Beckton Lana W525 D  
 Beckton Nebula M045  
 Beckton Lana M809 EP  
 Beckton Nebula P P707  
 WCRA Sirra E120 N  
 Beckton Sierra C254 W

BWt 80  
 WR 130  
 YWt. 1063  
 YR 115  
 FebADG NA  
 Frame 5.0  
 Feet Good

DAM		Calv.Ease	BW	WW	YW	Milk	HPG	Stay	Maint.En.	
Age	5	EPDs	16	-4.9	59	97	35	11	16	4.0
Wt	985	Marb	+5.50		REA	-.07		Bfat	+0.05	
Prog. BW	75	Beef Tenderness →	DNA: NA / NA		Scan: 1.8 / Tender					
WR	116	HerdBuilder Index: 61	Pct: 78%	ProS: 104	Pct: 32%					
YR	111	★★★★★ for Growth, Marbling, Superior Cow, Calving Ease.								
Udder	Very Good									
Wean Pct.	66%									
Cow Eff.	NA									

## 72 Beckton Scamp K241 A6

1-A 100% # 4675407 Tat: BKT2 K241

Birth: 3-17-22

Beckton Scamp B720 L4  
 Beckton Scamp E175 N5  
 Ref. S-1  
 Beckton Belga W103 N

Beckton Scamp X458 H3  
 Beckton Larkaba Y448 L  
 Beckton Nebula T398 V3  
 Beckton Belga T551 EP  
 Beckton Accent U777 C2  
 Beckton Christy W779 C  
 Beckton Accent B653 C3  
 Beckton Serena D008 A  
 Beckton Serena B275 A

BWt 64  
 WR 95  
 YWt. 1040  
 YR 104  
 FebADG 3.08  
 Frame 5.5  
 Feet Good

DAM		Calv.Ease	BW	WW	YW	Milk	HPG	Stay	Maint.En.	
Age	6	EPDs	18	-5.7	50	92	28	11	17	-2.0
Wt	1095	Marb	+4.6		REA	-.05		Bfat	+0.04	
Prog. BW	67	Beef Tenderness →	DNA: 10 / Outstanding		Scan: 1.5 / Tender +					
WR	98	HerdBuilder Index: 61	Pct: 38%	ProS: 114	Pct: 18%					
YR	95	★★★★★ for Low Maintenance, Marbling, Calving Ease.								
Udder	Very Good									
Wean Pct.	42%									
Cow Eff.	89									

\*Note: Scrotal and ultrasound data will be available later

# 73

## Beckton Likable K343 R4

1-A 100% # 4675759 Tat: BKT2 K343



Birth: 3-23-22  
 Beckton Likable U130 L2 < Beckton Likable S633  
 Beckton Kit S478 LN  
**Beckton Likable E636 C3**  
 Ref. L-3 < Beckton Minola W808 C < BKT Clifftop TP R288  
 Beckton Minola R604 CD  
 Beckton Roosevelt D391 L2 < Bieber Roosevelt W384  
 Beckton Indigo Y406 L  
**Beckton Coca F060 R**  
 Beckton Coca D301 D < Beckton Dominor A378 W7  
 Beckton Coca X701 N

BWt 61  
 WR 103  
 YWt. 1015  
 YR 101  
 FebADG 3.21  
 Frame 5.5  
 Feet Good

DAM		Calv.Ease	BW	WW	YW	Milk	HPG	Stay	Maint.En.	
Age	4	EPDs	18	-4.7	53	81	29	13	17	-2.0
Wt	745	Marb	+3.0		REA	+2.7		Bfat	+0.4	
Prog. BW	62	Beef Tenderness →	DNA: 9 / Outstanding		Scan:	1.7 / Tender				
WR	105	HerdBuilder Index:	78	Pct.: 12%	ProS:	93	Pct.: 49%			
YR	104	★★★★★ for Low Maintenance, Marbling, Rib-eye area, Superior Cow, Cow Efficiency, Calving Ease.								
Udder	Very Good									
Wean Pct.	62%									
Cow Eff.	131									



Lot 73

# 75

## Beckton Ranger K363 H7

1-A 100% # 4675413 Tat: BKT2 K363



Birth: 3-24-22  
 Beckton Ranger B006 D5 < Beckton Ranger Z225 J4  
 Beckton Suffeina Z731 D  
**Beckton Ranger G299 N6**  
 Ref. R-1 < Beckton Indigo C018 N < Beckton Nebula A773 L4  
 Beckton Indigo A849 N  
 Beckton Heritage B612 J4 < Beckton Heritage X403 L3  
 Beckton Lana N291 JC  
**Beckton Lana D088 H**  
 Beckton Lana B526 L < Beckton Likable U130 L2  
 Beckton Lana Y193 N

BWt 61  
 WR 100  
 YWt. 1021  
 YR 102  
 FebADG 3.56  
 Frame 5.5  
 Feet Good

DAM		Calv.Ease	BW	WW	YW	Milk	HPG	Stay	Maint.En.	
Age	6	EPDs	17	-4.9	61	100	27	12	17	2.0
Wt	1100	Marb	+4.8		REA	+0.1		Bfat	+0.4	
Prog. BW	68	Beef Tenderness →	DNA: 8 / Very Good		Scan:	1.5 / Tender +				
WR	101	HerdBuilder Index:	68	Pct.: 26%	ProS:	114	Pct.: 19%			
YR	98	★★★★★ for Gainability, Marbling, Calving Ease.								
Udder	Very Good									
Wean Pct.	44%									
Cow Eff.	93									



Lot 75

# 74

## Beckton Scamp K213 L7

1-A 100% # 4676473 Tat: BSF2 K213



Birth: 3-14-22  
 Beckton Scamp E175 N5 < Beckton Scamp B720 L4  
 Beckton Belga W103 N  
**Beckton Scamp G006 C6**  
 Ref. S-2 < Beckton Firefly E769 C < Beckton Cardinal B074 N  
 Beckton Firefly B052 W  
 Beckton Likable Y362 L3 < Beckton Likable U130 L2  
 Beckton Tamara M515 LN  
**Beckton Angel C816 L**  
 Beckton Angel X450 N < Beckton Nebula T398 V3  
 Beckton Angel T004 CT

BWt 53  
 WR 101  
 YWt. 994  
 YR 100  
 FebADG 3.27  
 Frame 5.0  
 Feet Good

DAM		Calv.Ease	BW	WW	YW	Milk	HPG	Stay	Maint.En.	
Age	7	EPDs	21	-8.6	46	80	29	10	18	0.0
Wt	1040	Marb	+3.9		REA	-0.4		Bfat	+0.4	
Prog. BW	61	Beef Tenderness →	DNA: 7 / Very Good		Scan:	1.9 / Tender				
WR	99	HerdBuilder Index:	69	Pct.: 23%	ProS:	106	Pct.: 28%			
YR	98	★★★★★ for Low Maintenance, Marbling, Calving Ease.								
Udder	Very Good									
Wean Pct.	47%									
Cow Eff.	100									

\*Note: Scrotal and ultrasound data will be available later

# 76

## Beckton Nebula K633 L5

1-A 100% # 4676559 Tat: BSF2 K633



Birth: 4-9-22  
 Beckton Nebula T398 V3 < Beckton Nebula L P093  
 Beckton Minerva J615 VG  
**Beckton Nebula A773 L4**  
 Ref. N-2 < Beckton Mona X022 L < Beckton Likable U130 L2  
 Beckton Mona U584 CD  
 Beckton Likable Z057 L4 < Beckton Likable X445 J3  
 Beckton Minola X107 L  
**Beckton Indigo D691 L**  
 Beckton Indigo Y343 N < Beckton Nebula T398 V3  
 Beckton Indigo H150 LN

BWt 66  
 WR 114  
 YWt. 1001  
 YR 99  
 FebADG 4.00  
 Frame 5.5  
 Feet Good

DAM		Calv.Ease	BW	WW	YW	Milk	HPG	Stay	Maint.En.	
Age	6	EPDs	15	-4.6	57	90	31	14	23	3.0
Wt	1085	Marb	+3.4		REA	-0.5		Bfat	+0.3	
Prog. BW	64	Beef Tenderness →	DNA: 10 / Outstanding		Scan:	1.6 / Tender +				
WR	103	HerdBuilder Index:	103	Pct.: 1%	ProS:	127	Pct.: 8%			
YR	100	★★★★★ for Gainability, Marbling, Calving Ease.								
Udder	Very Good									
Wean Pct.	49%									
Cow Eff.	104									

\*Note: Scrotal and ultrasound data will be available later

## 77 Beckton Scamp K508 A6

1-A 100% # 4675741 Tat: BKT2 K508

Birth: 4-1-22

**Beckton Scamp E175 N5**  
Ref. S-1

**Beckton Mona F161 A**

Beckton Scamp B720 L4 < Beckton Scamp X458 H3  
Beckton Larkaba Y448 L

Beckton Nebula T398 V3  
Beckton Belga T551 EP

Beckton Accent B653 C3 < Beckton Accent U777 C2  
Beckton Christy W779 C

Beckton Legend U331 E2  
Beckton Mona U564 JT

BWt **64**

WR **109**

YWt. **1046**

YR **104**

FebADG **3.18**

Frame **5.5**

Feet **Good**

DAM		Calv.Ease	BW	WW	YW	Milk	HPG	Stay	Maint.En.	
Age	4	EPDs	19	-6.4	49	85	29	10	16	-1.0
Wt	895	Marb	+0.36		REA	-0.03		Bfat	+0.03	
Prog. BW	57	Beef Tenderness →	DNA: 10 / Outstanding		Scan:	2.3 / Tender				
WR	103	HerdBuilder Index:	60	Pct.: 40%	ProS:	95	Pct.: 45%			
YR	101	★★★★★ for Low Maintenance, Marbling, Calving Ease.								
Udder	Very Good									
Wean Pct.	55%									
Cow Eff.	115									

## 80 BSF Oracle K172 J3

2 99% # 4676923 Tat: BSF2 K172

Birth: 3-8-22

**Beckton Oracle H390 L2**  
Ref. 0-5

**BSF Justicia H475 J**

Schuler Oracle-7142E < Schuler Sudden Impact 0004X  
Sor Marlee Cmmtmt 0470X

Beckton Lana D222 L < Beckton Legend S670  
Beckton Lana T348 NB

Beckton Julian E423 N8 < Beckton Julian Z382 J7  
Beckton Belga B004 N

Beckton Julian X465 J5  
BSF Justicia S777 JC

BWt **65**

WR **108**

YWt. **1072**

YR **109**

FebADG **3.78**

Frame **5.5**

Feet **Good**

DAM		Calv.Ease	BW	WW	YW	Milk	HPG	Stay	Maint.En.	
Age	2	EPDs	16	-2.6	71	121	27	NA	16	8.0
Wt	870	Marb	+0.62		REA	+0.15		Bfat	+0.04	
Prog. BW	65	Beef Tenderness →	DNA: 7 / Very Good		Scan:	1.9 / Tender				
WR	108	HerdBuilder Index:	55	Pct.: 50%	ProS:	122	Pct.: 11%			
YR	109	★★★★★ for Growth, Gainability, Marbling, Rib-eye area, Superior Cow, Calving Ease.								
Udder	Very Good									
Wean Pct.	49%									
Cow Eff.	103									

## 78 Beckton Heritage K539 A6

1-A 100% # 4675521 Tat: BKT2 K539

Birth: 4-3-22

**Beckton Heritage F615 L5**  
Ref. H-1

**Beckton Ruth E689 A**

Beckton Heritage B612 J4 < Beckton Heritage X403 L3  
Beckton Lana N291 JC

Beckton Likable U130 L2  
Beckton Mona U584 CD

Beckton Accent A485 C3 < Beckton Accent U777 C2  
Beckton Tamara R175 CQ

Beckton Jet U473 L2  
Beckton Ruth U557 JT

BWt **71**

WR **101**

YWt. **1024**

YR **97**

FebADG **2.64**

Frame **5.0**

Feet **Good**

DAM		Calv.Ease	BW	WW	YW	Milk	HPG	Stay	Maint.En.	
Age	5	EPDs	12	-2.3	60	89	29	10	15	-5.0
Wt	1220	Marb	+0.42		REA	+0.08		Bfat	+0.04	
Prog. BW	71	Beef Tenderness →	DNA: 10 / Outstanding		Scan:	2.1 / Tender				
WR	106	HerdBuilder Index:	44	Pct.: 71%	ProS:	78	Pct.: 74%			
YR	99	★★★★★ for Low Maintenance, Marbling, Calving Ease.								
Udder	Very Good									
Wean Pct.	46%									
Cow Eff.	97									

## 81 BSF Cardinal K235 A3

1-B 99% # 4677047 Tat: BKB2 K235

Birth: 3-15-22

**Beckton Cardinal E673 L**  
Ref. C-1

**BSF Lanette F217 A**

TR Ricardo DOS < TR Double Eagle ZT220  
Beckton Lana U182 JC

Beckton Legend U331 E2 < Beckton Larkaba T418 WA  
Beckton Larkaba A911 L

Beckton Accent D736 J4 < Beckton Accent A175 O3  
Beckton Larkaba W868 J

Beckton Accent W180 C2  
BSF Lanette Z660 C

BWt **63**

WR **89**

YWt. **1026**

YR **98**

FebADG **3.06**

Frame **5.0**

Feet **Good**

DAM		Calv.Ease	BW	WW	YW	Milk	HPG	Stay	Maint.En.	
Age	4	EPDs	20	-5.9	64	103	26	11	18	0.0
Wt	1005	Marb	+0.50		REA	+0.08		Bfat	+0.04	
Prog. BW	57	Beef Tenderness →	DNA: 7 / Very Good		Scan:	1.6 / Tender +				
WR	91	HerdBuilder Index:	78	Pct.: 11%	ProS:	129	Pct.: 7%			
YR	98	★★★★★ for Low Maintenance, Marbling, Calving Ease.								
Udder	NA									
Wean Pct.	47%									
Cow Eff.	99									

## 79 Beckton Oracle K467 A2

1-A 100% # 4676531 Tat: BSF2 K467

Birth: 3-30-22

**Schuler Oracle-7142E**  
Ref. 0-2

**Beckton Lana D754 A**

Schuler Sudden Impact 0004X < Red Crowfoot Ole's Oscar  
SOR Duchess TS 8915U

Sor Marlee Cmmtmt 0470X < Brown Commitment S7206  
SOR Marlee Beef 4511P

Beckton Accent W180 C2 < Beckton Cody K1 P014  
Beckton Christy R046 CQ

Beckton Justice G302  
Beckton Lana H725 CH

BWt **74**

WR **101**

YWt. **996**

YR **100**

FebADG **3.27**

Frame **5.5**

Feet **Good**

DAM		Calv.Ease	BW	WW	YW	Milk	HPG	Stay	Maint.En.	
Age	6	EPDs	16	-3.0	58	96	23	12	18	-1.0
Wt	1035	Marb	+0.67		REA	+0.12		Bfat	+0.04	
Prog. BW	68	Beef Tenderness →	DNA: 7 / Very Good		Scan:	1.7 / Tender				
WR	103	HerdBuilder Index:	78	Pct.: 11%	ProS:	135	Pct.: 4%			
YR	101	★★★★★ for Low Maintenance, Marbling, Calving Ease.								
Udder	Very Good									
Wean Pct.	48%									
Cow Eff.	100									



Lot 79

\*Note: Scrotal and ultrasound data will be available later

**82****Beckton Scamp K285 S7**

1-A 100% # 4676687 Tat: BSF2 K285



Birth: 3-19-22	Beckton Scamp D325 N5	Beckton Scamp A627 J4	
	Beckton Scamp G236 L6	Beckton Tamara Y039 N	
Ref. S-3	Beckton Indigo Y406 L	Beckton Likable U130 L2	
		Beckton Indigo R745 WR	
	Beckton Scamp B720 L4	Beckton Scamp X458 H3	
<b>Beckton Christy F479 S</b>	Beckton Larkaba Y448 L	Beckton Larkaba Y448 L	
	Beckton Justice C1 R483	Beckton Christy R434 CD	

BWt	57
WR	93
YWt.	1037
YR	104
FebADG	3.63
Frame	5.0
Feet	Good

<b>DAM</b>	Age	4	Calv.Ease	BW	WW	YW	Milk	HPG	Stay	Maint.En.
	Wt	1070	EPDs	21	-5.7	60	104	27	12	-1.0
	Prog. BW	57	Marb	+0.32	REA	+0.11	Bfat	+0.01		
	WR	93	Beef Tenderness	→	DNA: 7 / Very Good	Scan: 2.0 / Tender				
	YR	104	HerdBuilder Index:	41	Pct.: 76%	ProS: 93	Pct.: 49%			
	Udder	Very Good	★★★★★ for Low Maintenance, Gainability, Marbling, Calving Ease.							
	Wean Pct.	40%								
	Cow Eff.	85								



Lot 82

**84****Beckton Scamp K082 R7**

1-A 100% # 4676137 Tat: BKT2 K082



Birth: 2-24-22	Beckton Scamp F172 N5	Beckton Scamp B720 L4	
	<b>Beckton Scamp H076 E6</b>	Beckton Angel X450 N	
Ref. S-4	Beckton Larkaba F349 E	Beckton Epic B310 J6	
		Beckton Larkaba B409 L	
	Beckton Ranger B006 D5	Beckton Ranger Z225 J4	
<b>Beckton Larkeisa H434 R</b>	Beckton Sufaina Z731 D	Beckton Epic X330 L6	
	Beckton Epic X330 L6	Beckton Larkeisa X091 L	

BWt	77
WR	108
YWt.	1056
YR	109
FebADG	3.34
Frame	5.5
Feet	Good

<b>DAM</b>	Age	2	Calv.Ease	BW	WW	YW	Milk	HPG	Stay	Maint.En.
	Wt	980	EPDs	14	-0.3	70	115	29	NA	12
	Prog. BW	77	Marb	+0.38	REA	+0.10	Bfat	+0.04		
	WR	108	Beef Tenderness	→	DNA: 8 / Very Good	Scan: 1.6 / Tender +				
	YR	109	HerdBuilder Index:	33	Pct.: 87%	ProS: 75	Pct.: 77%			
	Udder	Very Good	★★★★★ for Growth, Marbling, Superior Cow, Calving Ease.							
	Wean Pct.	40%								
	Cow Eff.	85								

**85****Beckton Scamp K741 L7**

1-A 100% # 4675421 Tat: BKT2 K741



Birth: 4-20-22	Beckton Scamp D325 N5	Beckton Scamp A627 J4	
	<b>Beckton Scamp G236 L6</b>	Beckton Tamara Y039 N	
Ref. S-3	Beckton Indigo Y406 L	Beckton Likable U130 L2	
		Beckton Indigo R745 WR	
	Beckton Likable B154 W4	Beckton Likable Y124 L3	
<b>Beckton Susan D158 L</b>	Beckton Christy W429 W	Beckton Christy W429 W	
	Beckton Susan B781 N	Beckton Nebula P P707	
		Beckton Susan W058 E	

BWt	73
WR	107
YWt.	1036
YR	104
FebADG	3.97
Frame	5.5
Feet	Good

<b>DAM</b>	Age	6	Calv.Ease	BW	WW	YW	Milk	HPG	Stay	Maint.En.
	Wt	965	EPDs	17	-4.2	63	107	31	NA	16
	Prog. BW	71	Marb	+0.40	REA	+0.06	Bfat	+0.03		
	WR	114	Beef Tenderness	→	DNA: 7 / Very Good	Scan: 1.4 / Tender +				
	YR	113	HerdBuilder Index:	64	Pct.: 34%	ProS: 107	Pct.: 27%			
	Udder	Very Good	★★★★★ for Gainability, Marbling, Superior Cow, Calving Ease.							
	Wean Pct.	54%								
	Cow Eff.	114								

**83****Beckton Julian K460 E2**

1-A 100% # 4675435 Tat: BKT2 K460



Birth: 3-30-22	Beckton Julian 7526G	Beckton Julian 6592	
	<b>Beckton Julian GG B571</b>	Bkt Belga 6746 GS	
Ref. J-1	Bkt Marta 9A13 JL	Beckton Julian 7526G	
		Bkt Marta 6498 XM	
	Beckton Epic Z674 E6	Beckton Epic U749 D5	
<b>Beckton Christy D202 E</b>	Beckton Indigo U504 EP	Beckton Indigo U504 EP	
	Beckton Julio L233	Beckton Christy K101 CD	

BWt	64
WR	101
YWt.	1024
YR	102
FebADG	3.50
Frame	5.0
Feet	Good

<b>DAM</b>	Age	6	Calv.Ease	BW	WW	YW	Milk	HPG	Stay	Maint.En.
	Wt	905	EPDs	20	-7.2	45	73	27	15	-9.0
	Prog. BW	64	Marb	+0.49	REA	+0.04	Bfat	+0.05		
	WR	101	Beef Tenderness	→	DNA: 8 / Very Good	Scan: 1.5 / Tender +				
	YR	100	HerdBuilder Index:	66	Pct.: 29%	ProS: 101	Pct.: 36%			
	Udder	Very Good	★★★★★ for Low Maintenance, Gainability, Marbling, Calving Ease.							
	Wean Pct.	52%								
	Cow Eff.	110								

**86****Beckton Cardinal K609 L2**

1-A 100% # 4675711 Tat: BKT2 K609



Birth: 4-8-22	TR Double Eagle ZT220	TR Ricardo DOS	
	<b>Beckton Cardinal E673 L</b>	Beckton Lana U182 JC	
Ref. C-1	Beckton Larkaba A911 L	Beckton Legend U331 E2	
		Beckton Larkaba T418 WA	
	Beckton Likable B032 C5	Beckton Likable Z057 L4	
<b>Beckton Eola F275 L</b>	Beckton Mona Z270 C	Beckton Julian G3 P608	
	Beckton Eola U689 JL	Beckton Eola N491 LN	

BWt	62
WR	102
YWt.	1074
YR	108
FebADG	3.75
Frame	5.5
Feet	Good

<b>DAM</b>	Age	4	Calv.Ease	BW	WW	YW	Milk	HPG	Stay	Maint.En.
	Wt	1040	EPDs	22	-6.9	61	106	28	14	8.0
	Prog. BW	54	Marb	+0.51	REA	+0.18	Bfat	+0.03		
	WR	109	Beef Tenderness	→	DNA: 9 / Outstanding	Scan: 2.5 / Tender				
	YR	112	HerdBuilder Index:	57	Pct.: 46%	ProS: 117	Pct.: 16%			
	Udder	Very Good	★★★★★ for Growth, Gainability, Marbling, Rib-eye area, Superior Cow, Calving Ease.							
	Wean Pct.	46%								
	Cow Eff.	96								

\*Note: Scrotal and ultrasound data will be available later

## 87 BSF Epic K087 E9

1-B 99% # 4676895 Tat: BSF2 K087

Birth: 2-25-22

Beckton Epic H312 A8  
Ref. E-2

Beckton Epic D001 L7  
Beckton Larkaba B352 A

BSF Laurel H634 E  
BSF Laurel Z262 N

Beckton Epic B483 N6  
Beckton Mona B713 L

Beckton Accent Y260 L3  
Beckton Larkaba Y156 N

Beckton Epic B483 N6  
Beckton Mona B713 L

Beckton Nomad X290 N3  
BSF Laurel X073 E

BWt 75  
WR 104  
YWt. 1000  
YR 102  
FebADG 2.97  
Frame 5.5  
Feet Good

DAM		Calv.Ease	BW	WW	YW	Milk	HPG	Stay	Maint.En.
Age	2	EPDs	12	-1.9	63	103	29	18	8.0
Wt	830	Marb	+0.43		REA	+0.04		Bfat	+0.04
Prog. BW	75	Beef Tenderness →	DNA: 10 / Outstanding		Scan:	1.6 / Tender +			
WR	104	HerdBuilder Index:	58	Pct.: 45%	ProS:	90	Pct.: 54%		
YR	102	★★★★★ for Marbling, Calving Ease.							
Udder	Very Good								
Wean Pct.	49%								
Cow Eff.	104								

## 90 Beckton Likable K723 N4

1-A 100% # 4676411 Tat: BSF2 K723

Birth: 4-19-22

Beckton Likable E636 C3  
Ref. L-3

Beckton Likable U130 L2  
Beckton Minola W808 C

Beckton Minerva A470 N  
Beckton Minerva Y520 J

Beckton Likable S633  
Beckton Kit S478 LN

BKT Clifftop TP R288  
Beckton Minola R604 CD

Beckton Nebula W065 C3  
Beckton Rose W402 N

Beckton Julian U742 W5  
Beckton Minerva U586 CT

BWt 68  
WR 100  
YWt. 1073  
YR 107  
FebADG 3.77  
Frame 5.0  
Feet Good

DAM		Calv.Ease	BW	WW	YW	Milk	HPG	Stay	Maint.En.
Age	9	EPDs	14	-2.8	53	83	27	13	15
Wt	1015	Marb	+0.34		REA	+0.16		Bfat	+0.03
Prog. BW	71	Beef Tenderness →	DNA: 10 / Outstanding		Scan:	1.8 / Tender			
WR	104	HerdBuilder Index:	60	Pct.: 41%	ProS:	81	Pct.: 69%		
YR	105	★★★★★ for Low Maintenance, Growth, Gainability, Marbling, Rib-eye area, Superior Cow, Calving Ease.							
Udder	Very Good								
Wean Pct.	46%								
Cow Eff.	97								

## 88 Beckton Dominor K688 L9

1-A 100% # 4676561 Tat: BSF2 K688

Birth: 4-15-22

Beckton Dominor F263 N8  
Ref. D-1

Beckton Dominor A378 W7  
Beckton Larkaba W272 N

Beckton Minerva D903 L  
Beckton Minerva Y654 N

Beckton Dominor Y005 V6  
Beckton Lana Y541 W

Beckton Nebula EN S347  
Beckton Larkaba N643 HR

Beckton Likable X445 J3  
Beckton Minola X107 L

Beckton Nebula T398 V3  
Beckton Minerva M369 LO

BWt 58  
WR 107  
YWt. 1075  
YR 107  
FebADG 2.91  
Frame 5.5  
Feet Good

DAM		Calv.Ease	BW	WW	YW	Milk	HPG	Stay	Maint.En.
Age	6	EPDs	19	-5.3	59	100	31	14	16
Wt	1170	Marb	+0.53		REA	+0.16		Bfat	+0.04
Prog. BW	60	Beef Tenderness →	DNA: 10 / Outstanding		Scan:	1.4 / Tender +			
WR	94	HerdBuilder Index:	64	Pct.: 33%	ProS:	119	Pct.: 13%		
YR	102	★★★★★ for Growth, Marbling, Rib-eye area, Calving Ease.							
Udder	Very Good								
Wean Pct.	43%								
Cow Eff.	90								

## 91 BSF Dominor K466 N9

1-B 99% # 4676787 Tat: BSF2 K466

Birth: 3-30-22

Beckton Dominor F263 N8  
Ref. D-1

Beckton Dominor A378 W7  
Beckton Larkaba W272 N

BSF Erica G235 N  
BSF Erica B207 L

Beckton Dominor Y005 V6  
Beckton Lana Y541 W

Beckton Nebula EN S347  
Beckton Larkaba N643 HR

Beckton Nebula B557 J3  
Beckton Larkaba T813 JC

Beckton Nebula P P707  
Beckton Legend S670  
BSF Erica W053 R

BWt 67  
WR 95  
YWt. 1054  
YR 108  
FebADG 3.83  
Frame 5.5  
Feet Good

DAM		Calv.Ease	BW	WW	YW	Milk	HPG	Stay	Maint.En.
Age	3	EPDs	17	-3.4	52	88	32	14	15
Wt	980	Marb	+0.45		REA	+0.09		Bfat	+0.04
Prog. BW	63	Beef Tenderness →	DNA: 7 / Very Good		Scan:	1.7 / Tender			
WR	100	HerdBuilder Index:	62	Pct.: 37%	ProS:	106	Pct.: 28%		
YR	107	★★★★★ for Growth, Gainability, Marbling, Calving Ease.							
Udder	Very Good								
Wean Pct.	41%								
Cow Eff.	87								

## 89 BSF Scamp K804 H6

1-B 99% # 4676641 Tat: BSF2 K804

Birth: 4-27-22

Beckton Scamp E175 N5  
Ref. S-1

Beckton Scamp B720 L4  
Beckton Belga W103 N

BSF Hustelle E045 H  
BSF Hustelle C233 J

Beckton Scamp X458 H3  
Beckton Larkaba Y448 L

Beckton Nebula T398 V3  
Beckton Belga T551 EP

Bieber H Hughes W109  
Beckton Lakme T689 NX

Beckton Julian A565 J4  
BSF Hustelle A756 E

BWt 77  
WR 108  
YWt. 1105  
YR 110  
FebADG 3.56  
Frame 5.5  
Feet Good

DAM		Calv.Ease	BW	WW	YW	Milk	HPG	Stay	Maint.En.
Age	5	EPDs	15	-4.0	61	105	29	11	17
Wt	1075	Marb	+0.42		REA	+0.00		Bfat	+0.03
Prog. BW	72	Beef Tenderness →	DNA: 9 / Outstanding		Scan:	1.7 / Tender			
WR	115	HerdBuilder Index:	61	Pct.: 40%	ProS:	105	Pct.: 31%		
YR	111	★★★★★ for Growth, Gainability, Marbling, Superior Cow, Calving Ease.							
Udder	Very Good								
Wean Pct.	47%								
Cow Eff.	99								



Lot 91

**92****Beckton Likable K329 H7**

1-A 100% # 4675837 Tat: BKT2 K329



Birth: 3-22-22

Beckton Likable B032 C5	Beckton Likable Z057 L4	BWt	66
Beckton Likable F287 J6	Beckton Mona Z270 C	WR	99
Ref. L-4	Beckton Julian U699 L5	YWt.	1089
Beckton Larkaba X064 J	Beckton Larkaba U475 CT	YR	111
Beckton Heritage D195 L4	Beckton Heritage A767 C3	FebADG	4.06
Beckton Minerva G119 H	Beckton Susan W846 L	Frame	5.5
Beckton Minerva A885 E	Beckton Epic Y484 N6	Feet	Good
	Beckton Minerva Y324 N		

<b>DAM</b>	Calv.Ease	BW	WW	YW	Milk	HPG	Stay	Maint.En.
Age	3							
Wt	985	EPDs	16	-3.4	64	115	26	13
Prog. BW	60	Marb	+.47		REA	+.05		Bfat
WR	103	Beef Tenderness	→		DNA	8 / Very Good		Scan: 2.1 / Tender
YR	110	HerdBuilder Index:	53	Pct.: 55%	ProS:	109	Pct.: 24%	
Udder	Very Good	★★★★★ for Growth, Gainability, Marbling, Calving Ease.						
Wean Pct.	40%							
Cow Eff.	85							

**95****Beckton Likable K674 A4**

1-A 100% # 4675467 Tat: BKT2 K674



Birth: 4-14-22

Beckton Likable U130 L2	Beckton Likable S633	BWt	94
Beckton Likable C229 R3	Beckton Kit S478 LN	WR	97
Ref. L-2	Beckton Roman J S158	YWt.	1072
Beckton Tamara X447 J	Beckton Tamara R834 JC	YR	106
Beckton Accent Y260 L3	Beckton Accent W180 C2	FebADG	3.84
Beckton Lana D445 A	Beckton Lana W463 L	Frame	5.0
Beckton Lana Y561 N	Beckton Nebula T269 E2	Feet	Good
	Beckton Lana T104 CT		

<b>DAM</b>	Calv.Ease	BW	WW	YW	Milk	HPG	Stay	Maint.En.
Age	6							
Wt	1270	EPDs	9	0.4	69	111	24	12
Prog. BW	74	Marb	+.37		REA	+.16		Bfat
WR	102	Beef Tenderness	→		DNA	9 / Outstanding		Scan: 2.1 / Tender
YR	104	HerdBuilder Index:	66	Pct.: 28%	ProS:	102	Pct.: 35%	
Udder	Poor	★★★★★ for Low Maintenance, Growth, Gainability, Marbling, Rib-eye area.						
Wean Pct.	36%							
Cow Eff.	75							

**93****Beckton Warrior K737 A8**

1-A 100% # 4675645 Tat: BKT2 K737



Birth: 4-20-22

Beckton Warrior D359 L6	Beckton Warrior Y108 E5	BWt	59
Beckton Warrior G356 N7	Beckton Lana W463 L	WR	104
Ref. W-1	Beckton New Era Y194	YWt.	1113
Beckton Larkaba B277 N	Beckton Larkaba U062 CB	YR	110
Beckton Accent B549 N3	Beckton Accent W180 C2	FebADG	3.27
Beckton Lana F680 A	Beckton Minerva Y654 N	Frame	5.0
Beckton Lana C353 E	Beckton Epic X464 L5	Feet	Good
	Beckton Lana W748 D		

<b>DAM</b>	Calv.Ease	BW	WW	YW	Milk	HPG	Stay	Maint.En.
Age	4							
Wt	1010	EPDs	18	-4.5	62	104	29	12
Prog. BW	57	Marb	+.32		REA	-.07		Bfat
WR	104	Beef Tenderness	→		DNA	9 / Outstanding		Scan: 1.5 / Tender +
YR	110	HerdBuilder Index:	57	Pct.: 48%	ProS:	92	Pct.: 50%	
Udder	Very Good	★★★★★ for Growth, Marbling, Superior Cow, Calving Ease.						
Wean Pct.	46%							
Cow Eff.	97							

**96****Beckton Scamp K702 H7**

1-A 100% # 4675811 Tat: BKT2 K702



Birth: 4-16-22

Beckton Scamp D325 N5	Beckton Scamp A627 J4	BWt	63
Beckton Scamp G236 L6	Beckton Tamara Y039 N	WR	104
Ref. S-3	Beckton Likable U130 L2	YWt.	1106
Beckton Indigo Y406 L	Beckton Indigo R745 WR	YR	113
Beckton Heritage D195 L4	Beckton Heritage A767 C3	FebADG	3.95
Beckton Pine Marie G191 H	Beckton Susan W846 L	Frame	5.5
BKT Pine Marie Z250 N	Beckton Nebula J R475	Feet	Good
	BKT Pine Marie U621 NB		

<b>DAM</b>	Calv.Ease	BW	WW	YW	Milk	HPG	Stay	Maint.En.
Age	3							
Wt	1050	EPDs	17	-4.8	63	111	27	13
Prog. BW	54	Marb	+.32		REA	+.03		Bfat
WR	95	Beef Tenderness	→		DNA	9 / Outstanding		Scan: 1.5 / Tender +
YR	104	HerdBuilder Index:	52	Pct.: 58%	ProS:	96	Pct.: 44%	
Udder	Very Good	★★★★★ for Low Maintenance, Growth, Gainability, Marbling, Calving Ease.						
Wean Pct.	42%							
Cow Eff.	89							

**94****Beckton Nebula K848 J5**

1-A 100% # 4676529 Tat: BSF2 K848



Birth: 5-4-22

Beckton Nebula T398 V3	Beckton Nebula L P093	BWt	73
Beckton Nebula A773 L4	Beckton Minerva J615 VG	WR	105
Ref. N-2	Beckton Likable U130 L2	YWt.	1074
Beckton Mona X022 L	Beckton Mona U584 CD	YR	107
Beckton Julian X721 E6	Beckton Larkaba X064 J	FebADG	3.70
Beckton Belga D455 J	Beckton Epic K1 K863	Frame	5.0
Beckton Belga M050 EP	Beckton Belga K588 HD	Feet	Good

<b>DAM</b>	Calv.Ease	BW	WW	YW	Milk	HPG	Stay	Maint.En.
Age	6							
Wt	935	EPDs	17	-4.8	58	89	31	14
Prog. BW	69	Marb	+.42		REA	-.13		Bfat
WR	104	Beef Tenderness	→		DNA	7 / Very Good		Scan: 1.4 / Tender +
YR	105	HerdBuilder Index:	118	Pct.: 1%	ProS:	153	Pct.: 1%	
Udder	Very Good	★★★★★ for Low Maintenance, Growth, Gainability, Marbling, Superior Cow, Calving Ease.						
Wean Pct.	53%							
Cow Eff.	111							

**97****BSF Heritage K002 H6**

1-B 99% # 4676965 Tat: BSF2 K002



Birth: 2-7-22

Beckton Heritage C477 J4	Beckton Heritage X403 L3	BWt	63
Beckton Heritage H181 N5	Beckton Ruth Z858 J	WR	96
Ref. H-2	Beckton Nebula T269 E2	YWt.	998
Beckton Sierra Y441 N	Beckton Sierra S120 HW	YR	103
Beckton Heritage C477 J4	Beckton Heritage X403 L3	FebADG	3.70
BSF Justicia H245 H	Beckton Ruth Z858 J	Frame	5.0
BSF Justicia D262 B	Bieber Roosevelt W384	Feet	Good
	BSF Justicia Z620 N		

<b>DAM</b>	Calv.Ease	BW	WW	YW	Milk	HPG	Stay	Maint.En.
Age	2							
Wt	970	EPDs	13	-2.8	51	76	30	NA
Prog. BW	63	Marb	+.28		REA	+.12		Bfat
WR	96	Beef Tenderness	→		DNA	10 / Outstanding		Scan: 1.9 / Tender
YR	103	HerdBuilder Index:	61	Pct.: 38%	ProS:	71	Pct.: 82%	
Udder	Very Good	★★★★★ for Low Maintenance, Gainability, Marbling, Calving Ease.						
Wean Pct.	36%							
Cow Eff.	75							

\*Note: Scrotal and ultrasound data will be available later



## 98 Beckton Scamp K095 J7

1-A 100% # 4676059 Tat: BKT2 K095



Birth: 2-27-22

Beckton Scamp F172 N5 < Beckton Scamp B720 L4  
Beckton Angel X450 N

**Beckton Scamp H076 E6**

Ref. S-4 < Beckton Larkaba F349 E < Beckton Epic B310 J6  
Beckton Larkaba B409 L

**Beckton Minerva H631 J**

< Beckton Julian F067 L7 < Beckton Julian D551 C6  
Beckton Indigo D786 L  
< Beckton Epic B310 J6  
Beckton Minerva C549 W

BWt	59
WR	97
YWt.	1020
YR	104
FebADG	3.89
Frame	5.5
Feet	Good

DAM	
Age	2
Wt	760
Prog. BW	59
WR	97
YR	104
Udder	Very Good
Wean Pct.	50%
Cow Eff.	105

Calv.Ease	BW	WW	YW	Milk	HPG	Stay	Maint.En.	
EPDs	18	-3.6	57	98	29	NA	15	6.0
Marb	+0.34		REA +0.06		Bfat +0.03			
Beef Tenderness	→		DNA: 8 / Very Good		Scan: 1.4 / Tender +			
HerdBuilder Index:	53	Pct.: 54%	ProS: 91		Pct.: 52%			

★ ★ ★ ★ ★ for Gainability, Marbling, Calving Ease.

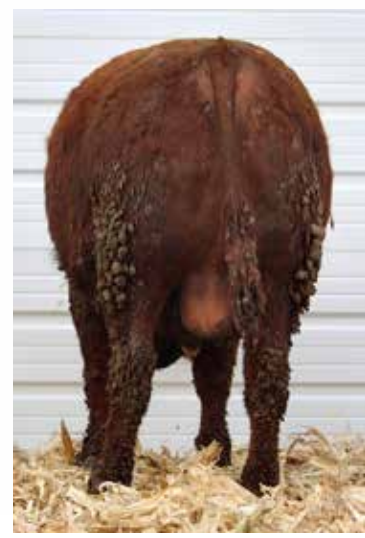

Lot 100

## 99 BSF Warrior K405 N8

1-B 99% # 4676395 Tat: BKT2 K405



Birth: 3-27-22

Beckton Warrior D359 L6 < Beckton Warrior Y108 E5  
Beckton Lana W463 L

**Beckton Warrior G356 N7**

Ref. W-1 < Beckton Larkaba B277 N < Beckton New Era Y194  
Beckton Larkaba U062 CB

**BSF Justicia A684 N**

< Beckton Nebula W778 J4 < Beckton Nebula PJ S543  
Beckton Lana S197 JT  
< Beckton Justice C1 R483  
BSF Regus M638 WR

BWt	84
WR	87
YWt.	1025
YR	102
FebADG	3.58
Frame	5.0
Feet	Good

DAM	
Age	9
Wt	NA
Prog. BW	66
WR	103
YR	104
Udder	Very Good
Wean Pct.	NA%
Cow Eff.	NA

Calv.Ease	BW	WW	YW	Milk	HPG	Stay	Maint.En.	
EPDs	16	-3.5	47	79	27	14	17	2.0
Marb	+0.36		REA -0.06		Bfat +0.03			
Beef Tenderness	→		DNA: 9 / Outstanding		Scan: 1.8 / Tender			
HerdBuilder Index:	55	Pct.: 52%	ProS: 92		Pct.: 50%			

★ ★ ★ ★ ★ for Gainability, Marbling, Calving Ease.



Lot 99

## 100 Beckton Scamp K152 A7

1-A 100% # 4676169 Tat: BKT2 K152



Birth: 3-7-22

Beckton Scamp E175 N5 < Beckton Scamp B720 L4  
Beckton Belga W103 N

**Beckton Scamp H356 D6**

Ref. S < Beckton Christy C149 D < Beckton Dominor A378 W7  
Beckton Christy A234 N

**Beckton Coca H272 A**

< Beckton Accent D326 N4 < Beckton Accent Y260 L3  
Beckton Lydia S069 NB  
< Beckton Nebula X603 J4  
Beckton Coca X701 N

BWt	55
WR	101
YWt.	1008
YR	102
FebADG	3.27
Frame	5.0
Feet	Good

DAM	
Age	2
Wt	910
Prog. BW	55
WR	101
YR	102
Udder	NA
Wean Pct.	43%
Cow Eff.	91

Calv.Ease	BW	WW	YW	Milk	HPG	Stay	Maint.En.	
EPDs	19	-5.9	51	86	29	NA	19	2.0
Marb	+0.48		REA -0.01		Bfat +0.03			
Beef Tenderness	→		DNA: 7 / Very Good		Scan: 2.4 / Tender			
HerdBuilder Index:	80	Pct.: 9%	ProS: 121		Pct.: 12%			

★ ★ ★ ★ ★ for Marbling, Calving Ease.



Lot 100

\*Note: Scrotal and ultrasound data will be available later

**101****BSF Likable K145 L6**

1-B 99% # 4676975 Tat: BSF2 K145



Birth: 3-6-22

Beckton Likable E391 N4 < Beckton Likable Y124 L3  
 Beckton Lana X466 N  
**Beckton Likable H518 N5**  
 Ref. L-7 < Beckton Nebula T398 V3  
 Beckton Serena S649 LO  
 Beckton Likable B032 C5  
 Beckton Firefly Z112 L  
**BSF Wendie H213 L**  
 Beckton Likable F834 L6 < Beckton Accent B150 N4  
 BSF Wendie F848 A < BSF Wendie C536 S

BWt 53  
 WR 101  
 YWt. 1019  
 YR 103  
 FebADG 3.33  
 Frame 5.5  
 Feet Good

DAM		Calv.Ease	BW	WW	YW	Milk	HPG	Stay	Maint.En.	
Age	2	EPDs	15	-3.8	60	97	25	12	17	2.0
Wt	890	Marb	+.46		REA	+.05		Bfat	+.03	
Prog. BW	53	Beef Tenderness →	DNA: 10 / Outstanding		Scan:	1.5 / Tender +				
WR	101	HerdBuilder Index:	67	Pct.: 27%	ProS:	106	Pct.: 29%			
YR	103	★★★★★ for Marbling, Calving Ease.								
Udder	Very Good									
Wean Pct.	44%									
Cow Eff.	93									

**104****Beckton Accent K455 N5**

1-A 100% # 4676629 Tat: BSF2 K455



Birth: 3-30-22

Beckton Accent E172 L3 < Beckton Accent W180 C2  
 Beckton Indigo Y406 L  
**Beckton Accent G107 C4**  
 Ref. A-5 < TR Double Eagle ZT220  
 Beckton Pine Marie E206 D < BKT Pine Marie W404 J  
 Beckton Nebula T269 E2  
 Beckton Indigo T613 JT  
**Beckton Coca E765 N**  
 Beckton Nebula X267 J3 < Beckton Legend S670  
 Beckton Coca C518 L < Beckton Coca X734 C

BWt 57  
 WR 102  
 YWt. 997  
 YR 100  
 FebADG 3.30  
 Frame 5.0  
 Feet Good

DAM		Calv.Ease	BW	WW	YW	Milk	HPG	Stay	Maint.En.	
Age	5	EPDs	23	-8.7	47	78	31	13	18	-5.0
Wt	845	Marb	+.36		REA	-.01		Bfat	+.03	
Prog. BW	47	Beef Tenderness →	DNA: 10 / Outstanding		Scan:	1.3 / Tender +				
WR	98	HerdBuilder Index:	83	Pct.: 7%	ProS:	112	Pct.: 20%			
YR	96	★★★★★ for Low Maintenance, Marbling, Cow Efficiency, Calving Ease.								
Udder	Very Good									
Wean Pct.	58%									
Cow Eff.	123									

**102****Beckton Julian K070 A9**

1-A 100% # 4676977 Tat: BSF2 K070



Birth: 2-21-22

Beckton Julian F067 L7 < Beckton Julian D551 C6  
 Beckton Indigo D786 L  
**Beckton Julian H042 S8**  
 Ref. J-7 < Beckton Scamp B720 L4  
 Beckton Indigo A849 N  
 Beckton Accent B549 N3 < Beckton Accent W180 C2  
 Beckton Minerva Y654 N  
**Beckton Coca H201 A**  
 Beckton Coca D679 L < Beckton Likable Z057 L4  
 Beckton Coca W438 N

BWt 52  
 WR 90  
 YWt. 1014  
 YR 103  
 FebADG 3.43  
 Frame 5.0  
 Feet Good

DAM		Calv.Ease	BW	WW	YW	Milk	HPG	Stay	Maint.En.	
Age	2	EPDs	20	-6.3	57	111	23	NA	15	7.0
Wt	780	Marb	+.67		REA	-.04		Bfat	+.05	
Prog. BW	52	Beef Tenderness →	DNA: 9 / Outstanding		Scan:	1.7 / Tender				
WR	90	HerdBuilder Index:	46	Pct.: 68%	ProS:	130	Pct.: 6%			
YR	103	★★★★★ for Marbling, Calving Ease.								
Udder	Very Good									
Wean Pct.	45%									
Cow Eff.	94									



Lot 104

**103****Beckton Scamp K458 L7**

1-A 100% # 4675493 Tat: BKT2 K458



Birth: 3-30-22

Beckton Scamp D325 N5 < Beckton Scamp A627 J4  
 Beckton Tamara Y039 N  
**Beckton Scamp G236 L6**  
 Ref. S-3 < Beckton Likable U130 L2  
 Beckton Indigo R745 WR  
 Beckton Legend X561 J2  
 Beckton Larkaba W868 J  
**Beckton Rose E642 L**  
 Beckton Legend Z689 J3 < Beckton Lancer T9 N586  
 Beckton Rose S487 LN < Beckton Rose L083 LN

BWt 70  
 WR 104  
 YWt. 1069  
 YR 107  
 FebADG 3.75  
 Frame 5.0  
 Feet Good

DAM		Calv.Ease	BW	WW	YW	Milk	HPG	Stay	Maint.En.	
Age	5	EPDs	15	-2.6	64	105	30	12	12	-6.0
Wt	1070	Marb	+.24		REA	+.26		Bfat	+.02	
Prog. BW	68	Beef Tenderness →	DNA: 10 / Outstanding		Scan:	1.5 / Tender +				
WR	111	HerdBuilder Index:	52	Pct.: 57%	ProS:	87	Pct.: 59%			
YR	110	★★★★★ for Low Maintenance, Growth, Gainability, Marbling, Rib-eye area, Superior Cow, Calving Ease.								
Udder	Very Good									
Wean Pct.	47%									
Cow Eff.	99									

**105****Beckton Oracle K621 L2**

1-A 100% # 4675185 Tat: BKT2 K621



Birth: 4-9-22

Schuler Sudden Impact 0004X < Red Crowfoot Ole's Oscar  
 SOR Duchess TS 8915U  
**Schuler Oracle-7142E**  
 Ref. O-2 < Brown Commitment S7206  
 Sor Marlee Cmmmtnt 0470X < SOR Marlee Beef 4511P  
 Beckton Lancer T371 H4  
 Beckton Minerva L324 LN  
**Beckton Firefly Z112 L**  
 Beckton Lancer X250 L5 < Beckton Dominor Z1 R610  
 Beckton Firefly X453 D < Beckton Firefly T284 WA

BWt 77  
 WR 110  
 YWt. 1064  
 YR 107  
 FebADG 3.24  
 Frame 5.5  
 Feet Good

DAM		Calv.Ease	BW	WW	YW	Milk	HPG	Stay	Maint.En.	
Age	10	EPDs	18	-3.9	61	104	25	11	13	0.0
Wt	1080	Marb	+.57		REA	+.30		Bfat	+.02	
Prog. BW	62	Beef Tenderness →	DNA: 7 / Very Good		Scan:	2.3 / Tender				
WR	103	HerdBuilder Index:	55	Pct.: 50%	ProS:	114	Pct.: 19%			
YR	102	★★★★★ for Low Maintenance, Growth, Marbling, Rib-eye area, Calving Ease.								
Udder	Very Good									
Wean Pct.	50%									
Cow Eff.	105									

\*Note: Scrotal and ultrasound data will be available later

## 106 Beckton Likable K367 A5

1-A 100% # 4675737 Tat: BKT2 K367



Birth: 3-25-22

Beckton Likable C229 R3 < Beckton Likable U130 L2  
 Beckton Tamara X447 J

**Beckton Likable G403 N4**

Ref. L-6 < Beckton Minerva Y385 N < Beckton Nebula T398 V3  
 Beckton Minerva U310 LO

Beckton Accent W180 C2 < Beckton Cody K1 P014  
 Beckton Christy R046 CQ

**Beckton Lana F171 A**

< Beckton Epic X330 L6  
 Beckton Lana U025 LO

BWt	57
WR	100
YWt.	1009
YR	101
FebADG	3.05
Frame	5.5
Feet	Good

DAM	
Age	4
Wt	960
Prog. BW	61
WR	108
YR	102
Udder	Very Good
Wean Pct.	49%
Cow Eff.	103

Calv.Ease	BW	WW	YW	Milk	HPG	Stay	Maint.En.	
EPDs	19	-6.1	59	95	27	10	19	-1.0
Marb	+0.31		REA +0.12		Bfat +0.04			
Beef Tenderness	→		DNA: 7 / Very Good		Scan: 1.6 / Tender +			
HerdBuilder Index:	84	Pct.: 7%	ProS: 113		Pct.: 19%			

★★★★★ for Low Maintenance, Marbling, Calving Ease.

## 108 Beckton Cardinal K313 L2

1-A 100% # 4675399 Tat: BKT2 K313



Birth: 3-21-22

TR Double Eagle ZT220 < TR Ricardo DOS  
 Beckton Lana U182 JC

**Beckton Cardinal E673 L**

Ref. C-1 < Beckton Larkaba A911 L < Beckton Legend U331 E2  
 Beckton Larkaba T418 WA

Beckton Loki X833 H4 < Beckton Vernice T447 HT  
 Beckton Nebula T398 V3

**Beckton Pine Marie D634 L**

< Beckton Pine Marie A975 N < BKT Pine Marie W404 J

BWt	47
WR	100
YWt.	993
YR	100
FebADG	4.06
Frame	5.0
Feet	Good

DAM	
Age	6
Wt	925
Prog. BW	55
WR	100
YR	99
Udder	NA
Wean Pct.	53%
Cow Eff.	111

Calv.Ease	BW	WW	YW	Milk	HPG	Stay	Maint.En.	
EPDs	24	-9.4	54	86	30	10	20	-3.0
Marb	+0.46		REA +0.07		Bfat +0.04			
Beef Tenderness	→		DNA: 9 / Outstanding		Scan: 1.4 / Tender +			
HerdBuilder Index:	91	Pct.: 3%	ProS: 134		Pct.: 5%			

★★★★★ for Low Maintenance, Gainability, Marbling, Calving Ease.

## 107 Beckton Accent K650 E4

1-A 100% # 4675451 Tat: BKT2 K650



Birth: 4-12-22

Beckton Accent W180 C2 < Beckton Cody K1 P014  
 Beckton Christy R046 CQ

**Beckton Accent B740 W3**

Ref. A-3 < Beckton Lana Y033 W < Beckton Warrior W534 N4  
 Beckton Lana W370 E

Beckton Epic Y484 N6 < Beckton Epic U749 D5  
 Beckton Lydia S069 NB

**Beckton Scarlett D331 E**

< Beckton Jet L P491  
 Beckton Scarlett R808 NB

BWt	73
WR	113
YWt.	1022
YR	103
FebADG	2.64
Frame	5.5
Feet	Good

DAM	
Age	6
Wt	1140
Prog. BW	65
WR	112
YR	108
Udder	Very Good
Wean Pct.	48%
Cow Eff.	101

Calv.Ease	BW	WW	YW	Milk	HPG	Stay	Maint.En.	
EPDs	16	-4.0	61	98	31	11	13	2.0
Marb	+0.37		REA +0.23		Bfat +0.03			
Beef Tenderness	→		DNA: 8 / Very Good		Scan: 1.6 / Tender +			
HerdBuilder Index:	35	Pct.: 85%	ProS: 54		Pct.: 95%			

★★★★★ for Marbling, Rib-eye area, Superior Cow, Calving Ease.



Lot 108



Lot 107

## 109 Beckton Scamp K225 L6

1-A 100% # 4675255 Tat: BKT2 K225



Birth: 3-15-22

Beckton Scamp B720 L4 < Beckton Scamp X458 H3  
 Beckton Larkaba Y448 L

**Beckton Scamp E175 N5**

Ref. S-1 < Beckton Belga W103 N < Beckton Nebula T398 V3  
 Beckton Belga T551 EP

Beckton Legend U331 E2 < Beckton Lana S669 EP  
 Beckton Jet L P491

**Beckton Mona B713 L**

< Beckton Mona U564 JT < Beckton Mona P874 WR

BWt	58
WR	96
YWt.	992
YR	100
FebADG	2.92
Frame	5.0
Feet	Good

DAM	
Age	8
Wt	950
Prog. BW	60
WR	93
YR	96
Udder	Very Good
Wean Pct.	49%
Cow Eff.	104

Calv.Ease	BW	WW	YW	Milk	HPG	Stay	Maint.En.	
EPDs	21	-7.5	48	84	26	9	17	-4.0
Marb	+0.40		REA +0.09		Bfat +0.03			
Beef Tenderness	→		DNA: 10 / Outstanding		Scan: 2.4 / Tender			
HerdBuilder Index:	71	Pct.: 20%	ProS: 112		Pct.: 21%			

★★★★★ for Low Maintenance, Marbling, Calving Ease.

\*Note: Scrotal and ultrasound data will be available later



Lot 109



Lot 112

**110 Beckton Oracle K197 A2** 1-A 100% # 4676405 Tat: BSF2 K197 

Birth: 3-12-22

Schuler Oracle-7142E  
 Ref. 0-2  
 Beckton Lana A083 A

Schuler Sudden Impact 0004X  
 Sor Marlee Cmmtmnt 0470X  
 Beckton Accent Y260 L3  
 Beckton Lana Y130 N

Red Crowfoot Ole's Oscar  
 SOR Duchess TS 8915U  
 Brown Commitment S7206  
 SOR Marlee Beef 4511P  
 Beckton Accent W180 C2  
 Beckton Lana W463 L  
 Beckton Nebula W022 D3  
 Beckton Lana W525 D

BWt	71
WR	98
YWt.	955
YR	96
FebADG	2.64
Frame	5.0
Feet	Good

DAM	
Age	9
Wt	1180
Prog. BW	71
WR	102
YR	97
Udder	Very Good
Wean Pct.	40%
Cow Eff.	85

Calv.Ease	BW	WW	YW	Milk	HPG	Stay	Maint.En.	
EPDs	16	-3.8	53	89	25	12	19	0.0
Marb	+.67		REA	+.06		Bfat		+.03
Beef Tenderness	→ DNA: 10 / Outstanding		Scan:		1.8 / Tender			
HerdBuilder Index:	86	Pct.: 5%	ProS:	143	Pct.: 2%			

★★★★★ for Low Maintenance, Marbling, Calving Ease.

**112 Beckton Oracle K653 E3** 1-A 100% # 4676585 Tat: BSF2 K653 

Birth: 4-12-22

Beckton Oracle G222 J2  
 Ref. 0-4  
 Beckton Indigo E780 E

Schuler Oracle-7142E  
 Beckton Rose E470 J  
 Beckton Epic A286 E7  
 Beckton Indigo Y343 N

Schuler Sudden Impact 0004X  
 Sor Marlee Cmmtmnt 0470X  
 Beckton Julian GG B571  
 Beckton Rose W346 E  
 Beckton Epic Y484 N6  
 Beckton Larkaba Y648 E  
 Beckton Nebula T398 V3  
 Beckton Indigo H150 LN

BWt	65
WR	110
YWt.	1030
YR	103
FebADG	1.71
Frame	5.5
Feet	Good

DAM	
Age	5
Wt	1080
Prog. BW	60
WR	102
YR	101
Udder	Very Good
Wean Pct.	50%
Cow Eff.	104

Calv.Ease	BW	WW	YW	Milk	HPG	Stay	Maint.En.	
EPDs	21	-7.4	51	84	29	11	16	2.0
Marb	+.47		REA	-.01		Bfat		+.05
Beef Tenderness	→ DNA: 10 / Outstanding		Scan:		1.5 / Tender +			
HerdBuilder Index:	67	Pct.: 27%	ProS:	101	Pct.: 36%			

★★★★★ for Marbling, Calving Ease.

**111 Beckton Scamp K148 L6** 1-A 100% # 4675323 Tat: BKT2 K148 

Birth: 3-6-22

Beckton Scamp E175 N5  
 Ref. S-1  
 Beckton Indigo C269 L

Beckton Scamp B720 L4  
 Beckton Belga W103 N  
 Beckton Likable Z057 L4  
 Beckton Indigo W772 N

Beckton Scamp X458 H3  
 Beckton Larkaba Y448 L  
 Beckton Nebula T398 V3  
 Beckton Belga T551 EP  
 Beckton Likable X445 J3  
 Beckton Minola X107 L  
 Beckton Nebula T398 V3  
 Beckton Indigo T613 JT

BWt	75
WR	98
YWt.	936
YR	94
FebADG	2.57
Frame	5.0
Feet	Good

DAM	
Age	7
Wt	1010
Prog. BW	65
WR	101
YR	101
Udder	NA
Wean Pct.	47%
Cow Eff.	99

Calv.Ease	BW	WW	YW	Milk	HPG	Stay	Maint.En.	
EPDs	16	-4.6	52	90	28	12	18	2.0
Marb	+.47		REA	-.02		Bfat		+.03
Beef Tenderness	→ DNA: 10 / Outstanding		Scan:		1.5 / Tender +			
HerdBuilder Index:	60	Pct.: 40%	ProS:	107	Pct.: 28%			

★★★★★ for Marbling, Calving Ease.



Lot 111

\*Note: Scrotal and ultrasound data will be available later

### 113 Beckton Epic K024 N9

1-A 100% # 4676069 Tat: BKT2 K024



Birth: 2-16-22

Beckton Epic H312 A8  
 Ref. E-2

Beckton Pine Marie H602 N

BWt	58
WR	112
YWt.	988
YR	100
FebADG	2.95
Frame	5.5
Feet	Good

DAM	
Age	2
Wt	855
Prog. BW	58
WR	112
YR	100
Udder	Very Good
Wean Pct.	52%
Cow Eff.	109

Calv.Ease	BW	WW	YW	Milk	HPG	Stay	Maint.En.	
EPDs	15	-3.4	65	100	30	NA	18	8.0
Marb	+0.44		REA +0.05		Bfat +0.05			
Beef Tenderness	→		DNA: 7 / Very Good		Scan: 1.7 / Tender			
HerdBuilder Index:	62	Pct.: 36%	ProS: 81		Pct.: 69%			

★★★★★ for Marbling, Calving Ease.

### 116 Beckton Accent K841 L4

1-A 100% # 4675627 Tat: BKT2 K841



Birth: 5-2-22

Beckton Accent B549 N3  
 Ref. A-2

Beckton Coca F826 L

BWt	72
WR	111
YWt.	1096
YR	110
FebADG	3.47
Frame	5.5
Feet	Good

DAM	
Age	4
Wt	955
Prog. BW	61
WR	103
YR	103
Udder	Very Good
Wean Pct.	54%
Cow Eff.	115

Calv.Ease	BW	WW	YW	Milk	HPG	Stay	Maint.En.	
EPDs	13	-2.6	68	114	26	13	17	6.0
Marb	+0.44		REA +0.19		Bfat +0.04			
Beef Tenderness	→		DNA: 9 / Outstanding		Scan: 1.6 / Tender +			
HerdBuilder Index:	64	Pct.: 34%	ProS: 107		Pct.: 27%			

★★★★★ for Growth, Marbling, Rib-eye area, Calving Ease.

### 114 Beckton Accent K391 A4

1-A 100% # 4675473 Tat: BKT2 K391



Birth: 3-26-22

Beckton Accent G208 N3  
 Ref. A-6

Beckton Rose D464 A

BWt	66
WR	99
YWt.	1032
YR	104
FebADG	3.14
Frame	5.0
Feet	Good

DAM	
Age	6
Wt	1200
Prog. BW	68
WR	100
YR	101
Udder	Very Good
Wean Pct.	40%
Cow Eff.	84

Calv.Ease	BW	WW	YW	Milk	HPG	Stay	Maint.En.	
EPDs	13	-0.8	67	113	23	12	18	3.0
Marb	+0.36		REA +0.05		Bfat +0.04			
Beef Tenderness	→		DNA: 8 / Very Good		Scan: 1.3 / Tender +			
HerdBuilder Index:	53	Pct.: 55%	ProS: 95		Pct.: 46%			

★★★★★ for Marbling, Calving Ease.

### 117 WCRA Dominor K192

A 100% # 4659643 Tat: WCRA2K192



Birth: 3-11-22

Beckton Dominor H423 N9  
 Ref. D-4

Carpenter Pine Marie B003 N

BWt	58
WR	95
YWt.	894
YR	97
FebADG	NA
Frame	5.0
Feet	Good

DAM	
Age	8
Wt	1050
Prog. BW	73
WR	111
YR	109
Udder	Very Good
Wean Pct.	45%
Cow Eff.	98

Calv.Ease	BW	WW	YW	Milk	HPG	Stay	Maint.En.	
EPDs	18	-4.8	56	95	27	14	17	-4.0
Marb	+0.47		REA -.03		Bfat +0.04			
Beef Tenderness	→		DNA: NA / NA		Scan: 1.9 / Tender			
HerdBuilder Index:	78	Pct.: 12%	ProS: 129		Pct.: 7%			

★★★★★ for Low Maintenance, Marbling, Superior Cow, Calving Ease.

### 115 Beckton Likable K232 D7

1-A 100% # 4676827 Tat: BSF2 K232



Birth: 3-15-22

Beckton Likable F287 J6  
 Ref. L-4

Beckton Larkabel G524 D

BWt	61
WR	104
YWt.	992
YR	101
FebADG	2.91
Frame	5.5
Feet	Good

DAM	
Age	3
Wt	800
Prog. BW	52
WR	101
YR	100
Udder	Good
Wean Pct.	56%
Cow Eff.	118

Calv.Ease	BW	WW	YW	Milk	HPG	Stay	Maint.En.	
EPDs	20	-6.5	52	87	27	15	17	0.0
Marb	+0.51		REA -.10		Bfat +0.05			
Beef Tenderness	→		DNA: 10 / Outstanding		Scan: 1.9 / Tender			
HerdBuilder Index:	80	Pct.: 10%	ProS: 116		Pct.: 16%			

★★★★★ for Low Maintenance, Marbling, Cow Efficiency, Calving Ease.



Lot 115

\*Note: Scrotal and ultrasound data will be available later

# 118

## Beckton Scamp K299 L7

1-A 100% # 4675523 Tat: BKT2 K299



Birth: 3-20-22  
 Beckton Scamp D325 N5 < Beckton Scamp A627 J4  
 Beckton Scamp G236 L6 < Beckton Tamara Y039 N  
 Ref. S-3 < Beckton Likable U130 L2  
 Beckton Indigo Y406 L < Beckton Indigo R745 WR  
 Beckton Likable Z057 L4 < Beckton Likable X445 J3  
 Beckton Sierra E649 L < Beckton Minola X107 L  
 Beckton Sierra Y441 N < Beckton Nebula T269 E2  
 Beckton Sierra S120 HW

BWt 66  
 WR 86  
 YWt. 982  
 YR 99  
 FebADG 3.31  
 Frame 5.0  
 Feet Good

DAM		Calv.Ease	BW	WW	YW	Milk	HPG	Stay	Maint.En.	
Age	5	EPDs	16	-5.9	47	84	30	11	13	-7.0
Wt	855	Marb	+.43		REA	-.05		Bfat	+.02	
Prog. BW	59	Beef Tenderness →	DNA: 9 / Outstanding		Scan:	1.6 / Tender +				
WR	96	HerdBuilder Index:	42	Pct.: 76%	ProS:	90	Pct.: 54%			
YR	97	★★★★★ for Low Maintenance, Marbling, Calving Ease.								
Udder	Very Good									
Wean Pct.	49%									
Cow Eff.	103									



Lot 118

# 120

## BSF Julian K137 N9

1-B 99% # 4676969 Tat: BSF2 K137



Birth: 3-5-22  
 Beckton Julian F067 L7 < Beckton Julian D551 C6  
 Beckton Julian H042 S8 < Beckton Indigo D786 L  
 Ref. J-7 < Beckton Scamp B720 L4  
 Beckton Indigo F643 S < Beckton Indigo A849 N  
 Beckton New Era Y194 < Beckton Nebula P P707  
 BSF Julianne H240 N < BKT Larkeisa T310 JC  
 BSF Julianne D131 L < Beckton Likable B154 W4  
 BSF Julianne B007 M8

BWt 56  
 WR 107  
 YWt. 1037  
 YR 105  
 FebADG 3.75  
 Frame 5.5  
 Feet Good

DAM		Calv.Ease	BW	WW	YW	Milk	HPG	Stay	Maint.En.	
Age	2	EPDs	20	-5.0	65	115	27	11	17	11.0
Wt	845	Marb	+.51		REA	+.04		Bfat	+.04	
Prog. BW	56	Beef Tenderness →	DNA: 10 / Outstanding		Scan:	1.4 / Tender +				
WR	107	HerdBuilder Index:	53	Pct.: 55%	ProS:	119	Pct.: 14%			
YR	105	★★★★★ for Growth, Gainability, Marbling, Superior Cow, Calving Ease.								
Udder	Very Good									
Wean Pct.	50%									
Cow Eff.	105									



Lot 120

# 119

## Beckton Nebula K497 L5

1-A 100% # 4677035 Tat: BKB2 K497



Birth: 4-1-22  
 Beckton Nebula B557 J3 < Beckton Nebula P P707  
 Beckton Nebula F440 H4 < Beckton Larkaba T813 JC  
 Ref. N-3 < Beckton Hasten H S462  
 Beckton Minola X638 H < Beckton Minola N751 JL  
 Beckton Likable U130 L2 < Beckton Likable S633  
 Beckton Indigo Y406 L < Beckton Kit S478 LN  
 Beckton Indigo R745 WR < Beckton Warrior CL M686  
 Beckton Indigo M514 CH

BWt 64  
 WR 98  
 YWt. 982  
 YR 99  
 FebADG 4.22  
 Frame 5.0  
 Feet Good

DAM		Calv.Ease	BW	WW	YW	Milk	HPG	Stay	Maint.En.	
Age	11	EPDs	15	-4.2	58	89	27	13	18	-2.0
Wt	985	Marb	+.41		REA	+.06		Bfat	+.03	
Prog. BW	65	Beef Tenderness →	DNA: 7 / Very Good		Scan:	2.0 / Tender				
WR	101	HerdBuilder Index:	78	Pct.: 11%	ProS:	109	Pct.: 25%			
YR	105	★★★★★ for Low Maintenance, Gainability, Marbling, Calving Ease.								
Udder	Very Good									
Wean Pct.	46%									
Cow Eff.	98									

\*Note: Scrotal and ultrasound data will be available later

# 121

## Beckton Likable K826 E4

1-A 100% # 4675281 Tat: BKT2 K826



Birth: 4-30-22  
 Beckton Likable U130 L2 < Beckton Likable S633  
 Beckton Likable C229 R3 < Beckton Kit S478 LN  
 Ref. L-2 < Beckton Roman J S158  
 Beckton Tamara X447 J < Beckton Tamara R834 JC  
 Beckton Epic X464 L5 < Beckton Epic K6 S569  
 Beckton Tamara B700 E < Beckton Lana M393 LN  
 Beckton Tamara Y585 N < Beckton Nebula U206 V3  
 Beckton Tamara U770 JL

BWt 67  
 WR 108  
 YWt. 1061  
 YR 107  
 FebADG 2.94  
 Frame 5.5  
 Feet Good

DAM		Calv.Ease	BW	WW	YW	Milk	HPG	Stay	Maint.En.	
Age	8	EPDs	14	-2.2	65	105	28	12	15	-1.0
Wt	1075	Marb	+.40		REA	+.24		Bfat	+.03	
Prog. BW	65	Beef Tenderness →	DNA: 9 / Outstanding		Scan:	1.7 / Tender				
WR	107	HerdBuilder Index:	62	Pct.: 37%	ProS:	93	Pct.: 50%			
YR	106	★★★★★ for Low Maintenance, Growth, Marbling, Rib-eye area, Superior Cow, Calving Ease.								
Udder	Very Good									
Wean Pct.	49%									
Cow Eff.	103									

## 122 BSF Epic K676 D8

1-B 99% # 4676773 Tat: BSF2 K676

Birth: 4-14-22

Beckton Epic G227 A7  
Ref. E-1

Beckton Epic B310 J6  
Beckton Lana Z916 A

BSF Laurel G279 D

Beckton Dominor D254 N8  
BSF Laurel Z262 N

Beckton Epic X464 L5  
Beckton Minerva Y116 J

Beckton Accent W180 C2  
Beckton Lana N664 JL

Beckton Dominor A378 W7  
Beckton Indigo W772 N

Beckton Nomad X290 N3  
BSF Laurel X073 E



BWt	66
WR	116
YWt.	1038
YR	106
FebADG	3.41
Frame	6.0
Feet	Good

DAM		Calv.Ease	BW	WW	YW	Milk	HPG	Stay	Maint.En.	
Age	3	EPDs	16	-2.9	62	95	30	13	17	3.0
Wt	1020	Marb	+4.0		REA	+0.2		Bfat	+0.3	
Prog. BW	63	Beef Tenderness	→		DNA: 7 / Very Good	Scan: 1.5 / Tender +				
WR	112	HerdBuilder Index: 73	Pct.: 17%		ProS: 98	Pct.: 40%				
YR	106	★★★★★ for Growth, Marbling, Superior Cow, Calving Ease.								
Udder	Good									
Wean Pct.	46%									
Cow Eff.	97									

## 124 Beckton Dominor K604 C10

1-A 100% # 4675911 Tat: BKT2 K604

Birth: 4-8-22

Beckton Dominor G402 A9  
Ref. D-2

Beckton Dominor D254 N8  
Beckton Lana D273 A

Beckton Rose G180 C

Beckton Clifftop C572 N5  
Beckton Rose D151 A

Beckton Dominor A378 W7  
Beckton Indigo W772 N

Beckton Accent B549 N3  
Beckton Lana B666 S

Beckton Clifftop Y012 C4  
BKT Pine Marie U454 NB

Beckton Accent W180 C2  
Beckton Rose X573 N



BWt	60
WR	115
YWt.	985
YR	101
FebADG	2.84
Frame	5.5
Feet	Good

DAM		Calv.Ease	BW	WW	YW	Milk	HPG	Stay	Maint.En.	
Age	3	EPDs	20	-6.1	55	88	29	NA	16	1.0
Wt	860	Marb	+4.3		REA	+0.9		Bfat	+0.5	
Prog. BW	60	Beef Tenderness	→		DNA: 5 / Average	Scan: 1.7 / Tender				
WR	110	HerdBuilder Index: 70	Pct.: 23%		ProS: 93	Pct.: 48%				
YR	102	★★★★★ for Marbling, Cow Efficiency, Calving Ease.								
Udder	Very Good									
Wean Pct.	58%									
Cow Eff.	122									

## 123 Beckton Accent K132 J5

1-A 100% # 4676175 Tat: BKT2 K132

Birth: 3-4-22

Beckton Accent H410 A4  
Ref. A-9

Beckton Accent B549 N3  
Beckton Minola C198 A

Beckton Lana H259 J

Beckton Julian E423 N8  
Beckton Lana W748 D

Beckton Accent W180 C2  
Beckton Minerva Y654 N

Beckton Accent A485 C3  
Beckton Minola A330 S

Beckton Julian Z382 J7  
Beckton Belga B004 N

Beckton Dominor Z1 R610  
Beckton Lana S858 JL



BWt	45
WR	101
YWt.	977
YR	99
FebADG	3.09
Frame	5.5
Feet	Good

DAM		Calv.Ease	BW	WW	YW	Milk	HPG	Stay	Maint.En.	
Age	2	EPDs	21	-7.6	57	92	28	13	17	0.0
Wt	915	Marb	+4.4		REA	+0.9		Bfat	+0.5	
Prog. BW	45	Beef Tenderness	→		DNA: 10 / Outstanding	Scan: 1.4 / Tender +				
WR	101	HerdBuilder Index: 76	Pct.: 14%		ProS: 107	Pct.: 27%				
YR	99	★★★★★ for Low Maintenance, Marbling, Calving Ease.								
Udder	Very Good									
Wean Pct.	43%									
Cow Eff.	91									

## 125 BSF Cardinal K279 A3

1-B 99% # 4676575 Tat: BSF2 K279

Birth: 3-19-22

Beckton Cardinal G043 C2  
Ref. C-2

Beckton Cardinal E673 L  
Beckton Minerva E181 D

BSF Hustelle E515 A

Beckton Accent A175 O3  
BSF Hustelle U113 LO

TR Double Eagle ZT220  
Beckton Larkaba A911 L

TR Double Eagle ZT220  
Beckton Minerva W901 J

Beckton Accent W180 C2  
Beckton Lana R214 RA

Beckton Loki CL S284  
BSF Hustelle S375 HU



BWt	68
WR	100
YWt.	868
YR	87
FebADG	1.81
Frame	5.0
Feet	Good

DAM		Calv.Ease	BW	WW	YW	Milk	HPG	Stay	Maint.En.	
Age	5	EPDs	19	-4.8	55	86	26	NA	16	6.0
Wt	1240	Marb	+3.8		REA	+0.8		Bfat	+0.3	
Prog. BW	66	Beef Tenderness	→		DNA: 7 / Very Good	Scan: 1.8 / Tender				
WR	96	HerdBuilder Index: 57	Pct.: 47%		ProS: 79	Pct.: 71%				
YR	98	★★★★★ for Marbling, Calving Ease.								
Udder	Good									
Wean Pct.	39%									
Cow Eff.	83									



Lot 121

## 126 Beckton Accent K588 N4

1-A 100% # 4675137 Tat: BKT2 K588

Birth: 4-7-22

Beckton Accent F602 L3  
Ref. A-4

Beckton Accent W180 C2  
Beckton Lana B670 L

Beckton Belga Y192 N

Beckton Nebula T398 V3  
Beckton Belga S026 NB

Beckton Cody K1 P014  
Beckton Christy R046 CQ

Beckton Likable U130 L2  
Beckton Lana Y541 W

Beckton Nebula L P093  
Beckton Minerva J615 VG

Beckton Nebula L P093  
Beckton Belga P119 EP



BWt	82
WR	97
YWt.	1029
YR	103
FebADG	3.53
Frame	5.0
Feet	Good

DAM		Calv.Ease	BW	WW	YW	Milk	HPG	Stay	Maint.En.	
Age	11	EPDs	14	-2.6	59	95	25	13	23	-6.0
Wt	1080	Marb	+3.4		REA	+1.3		Bfat	+0.4	
Prog. BW	71	Beef Tenderness	→		DNA: 9 / Outstanding	Scan: 1.8 / Tender				
WR	97	HerdBuilder Index: 117	Pct.: 1%		ProS: 149	Pct.: 1%				
YR	97	★★★★★ for Low Maintenance, Gainability, Marbling, Rib-eye area, Calving Ease.								
Udder	Very Good									
Wean Pct.	42%									
Cow Eff.	88									

\*Note: Scrotal and ultrasound data will be available later

# 127

## BSF Epic K595 E8

2 99% # 4676745 Tat: BSF2 K595



Birth: 4-7-22

Beckton Epic B310 J6  
**Beckton Epic G227 A7**  
 Ref. E-1  
 Beckton Lana Z916 A

Beckton Epic X464 L5  
 Beckton Minerva Y116 J  
 Beckton Accent W180 C2  
 Beckton Lana N664 JL  
 Beckton Epic B545 N7  
 Beckton Christy B701 E  
 Beckton Epic B545 N7  
 Beckton Epic B545 N7  
 BSF Nebulann B195 L

BWt 80  
 WR 103  
 YWt. 1030  
 YR 103  
 FebADG 2.81  
 Frame 5.0  
 Feet Good

**BSF Nebulann F048 E**

Beckton Epic D002 E8  
 BSF Nebulann D017 E

**DAM**  
 Age 4  
 Wt 990  
 Prog. BW 73  
 WR 107  
 YR 106  
 Udder Very Good  
 Wean Pct. 48%  
 Cow Eff. 102

Calv.Ease	BW	WW	YW	Milk	HPG	Stay	Maint.En.
EPDs 13	-1.6	63	100	29	12	15	0.0
Marb +.38		REA +.20				Bfat +.03	
Beef Tenderness →	DNA: 10 / Outstanding					Scan: 1.8 / Tender	
HerdBuilder Index: 60	Pct.: 41%					ProS: 94	Pct.: 47%

★★★★★ for Low Maintenance, Marbling, Rib-eye area, Superior Cow, Calving Ease.

# 130

## Beckton Accent K629 L4

1-A 100% # 4675261 Tat: BKT2 K629



Birth: 4-9-22

Beckton Accent W180 C2  
**Beckton Accent F602 L3**  
 Ref. A-4  
 Beckton Lana B670 L

Beckton Cody K1 P014  
 Beckton Christy R046 CQ  
 Beckton Likable U130 L2  
 Beckton Lana Y541 W  
 Beckton Likable U130 L2  
 BKT Pine Marie S802 L0  
 Beckton Dominor Z1 R610  
 Beckton Lana S858 JL

BWt 68  
 WR 97  
 YWt. 975  
 YR 97  
 FebADG 2.97  
 Frame 5.0  
 Feet Good

**Beckton Lana B316 L**

**DAM**  
 Age 8  
 Wt 1110  
 Prog. BW 67  
 WR 107  
 YR 108  
 Udder Very Good  
 Wean Pct. 41%  
 Cow Eff. 86

Calv.Ease	BW	WW	YW	Milk	HPG	Stay	Maint.En.
EPDs 20	-6.0	53	86	28	14	19	-2.0
Marb +.37		REA +.12				Bfat +.04	
Beef Tenderness →	DNA: 7 / Very Good					Scan: 1.6 / Tender +	
HerdBuilder Index: 94	Pct.: 2%					ProS: 123	Pct.: 11%

★★★★★ for Low Maintenance, Marbling, Superior Cow, Calving Ease.

# 128

## Beckton Cardinal K733 N2

1-A 100% # 4675189 Tat: BKT2 K733



Birth: 4-19-22

TR Double Eagle ZT220  
**Beckton Cardinal E673 L**  
 Ref. C-1  
 Beckton Larkaba A911 L

TR Ricardo DOS  
 Beckton Lana U182 JC  
 Beckton Legend U331 E2  
 Beckton Larkaba T418 WA  
 Beckton Nebula U206 V3  
 Beckton Tamara U185 NB  
 Beckton Heritage T270 J2  
 BKT Pine Marie R246 JE

BWt 43  
 WR 107  
 YWt. 1035  
 YR 104  
 FebADG 3.06  
 Frame 5.0  
 Feet Good

**BKT Pine Marie Z177 N**

Beckton Nebula X096 N4  
 BKT Pine Marie X540 H

**DAM**  
 Age 10  
 Wt 1270  
 Prog. BW 67  
 WR 115  
 YR 106  
 Udder Very Good  
 Wean Pct. 41%  
 Cow Eff. 86

Calv.Ease	BW	WW	YW	Milk	HPG	Stay	Maint.En.
EPDs 22	-8.2	61	96	32	12	18	7.0
Marb +.50		REA +.09				Bfat +.04	
Beef Tenderness →	DNA: 6 / Average					Scan: 1.7 / Tender	
HerdBuilder Index: 72	Pct.: 19%					ProS: 113	Pct.: 19%

★★★★★ for Marbling, Superior Cow, Calving Ease.

# 131

## Beckton Cardinal K098 L3

1-A 100% # 4676875 Tat: BSF2 K098



Birth: 2-27-22

Beckton Cardinal E673 L  
**Beckton Cardinal H671 E2**  
 Ref. C-3  
 Beckton Tamara B700 E

TR Double Eagle ZT220  
 Beckton Larkaba A911 L  
 Beckton Epic X464 L5  
 Beckton Tamara Y585 N  
 Beckton Likable U130 L2  
 Beckton Firefly W013 N  
 Beckton Nebula EN S347  
 Beckton Lana P073 EP

BWt 55  
 WR 99  
 YWt. 961  
 YR 98  
 FebADG 3.00  
 Frame 5.0  
 Feet Good

**Beckton Lana H721 L**

**DAM**  
 Age 2  
 Wt 825  
 Prog. BW 55  
 WR 99  
 YR 98  
 Udder Very Good  
 Wean Pct. 47%  
 Cow Eff. 98

Calv.Ease	BW	WW	YW	Milk	HPG	Stay	Maint.En.
EPDs 18	-5.3	57	97	33	NA	17	-1.0
Marb +.55		REA +.17				Bfat +.05	
Beef Tenderness →	DNA: 10 / Outstanding					Scan: 1.8 / Tender	
HerdBuilder Index: 83	Pct.: 7%					ProS: 133	Pct.: 5%

★★★★★ for Low Maintenance, Marbling, Rib-eye area, Calving Ease.

# 129

## Beckton Dominor K051 S8

1-A 100% # 4676071 Tat: BKT2 K051



Birth: 2-18-22

Beckton Dominor Y052 N6  
**Beckton Dominor H382 N7**  
 Ref. D-3  
 Beckton Coca E847 N

Beckton Dominor W640 C5  
 Beckton Indigo W772 N  
 Beckton Nebula Z111 N5  
 Beckton Coca A271 N  
 Beckton Scamp B720 L4  
 Beckton Belga W103 N  
 Beckton Nebula PJ S543  
 Beckton Coca T363 JL

BWt 57  
 WR 104  
 YWt. 985  
 YR 102  
 FebADG 3.34  
 Frame 5.0  
 Feet Good

**Beckton Coca H589 S**

Beckton Scamp E175 N5  
 Beckton Coca X675 N

**DAM**  
 Age 2  
 Wt 740  
 Prog. BW 57  
 WR 104  
 YR 102  
 Udder Very Good  
 Wean Pct. 51%  
 Cow Eff. 108

Calv.Ease	BW	WW	YW	Milk	HPG	Stay	Maint.En.
EPDs 17	-5.5	60	104	26	13	15	7.0
Marb +.51		REA -.12				Bfat +.04	
Beef Tenderness →	DNA: 9 / Outstanding					Scan: 1.7 / Tender	
HerdBuilder Index: 44	Pct.: 72%					ProS: 94	Pct.: 47%

★★★★★ for Marbling, Calving Ease.



Lot 129

\*Note: Scrotal and ultrasound data will be available later



### 132 Beckton Scamp K516 L7

1-A 100% # 4676363 Tat: BSF2 K516



Birth: 4-2-22

- Beckton Scamp D325 N5
- Beckton Scamp A627 J4
- Beckton Scamp G236 L6
- Beckton Tamara Y039 N
- Beckton Indigo Y406 L
- Beckton Likable U130 L2
- Beckton Indigo R745 WR
- Beckton Likable X445 J3
- Beckton Indigo U130 L2
- Beckton Indigo U658 JL
- Beckton Minola Z052 L
- Beckton Accent U777 C2
- Beckton Minola X198 A
- Beckton Minola U378 JL

BWt	63
WR	94
YWt.	941
YR	94
FebADG	3.38
Frame	5.0
Feet	Good

DAM	
Age	10
Wt	915
Prog. BW	66
WR	102
YR	100
Udder	Fair
Wean Pct.	50%
Cow Eff.	105

Calv.Ease	BW	WW	YW	Milk	HPG	Stay	Maint.En.
EPDs	18	-5.5	50	83	30	14	-10.0
Marb	+0.42		REA	-0.08		Bfat +0.02	
Beef Tenderness	→ DNA: 10 / Outstanding		Scan: 1.7 / Tender				
HerdBuilder Index:	60	Pct.: 42%	ProS:	91	Pct.: 53%		

★★★★★ for Low Maintenance, Marbling, Calving Ease.

### 134 Beckton Epic K770 L8

1-A 100% # 4675425 Tat: BKT2 K770



Birth: 4-23-22

- Beckton Epic B310 J6
- Beckton Epic X464 L5
- Beckton Epic G227 A7
- Beckton Minerva Y116 J
- Beckton Lana Z916 A
- Beckton Accent W180 C2
- Beckton Legend S670
- Beckton Lancer F442 T
- Beckton Belga D862 L
- Beckton Kit F468 JL
- Beckton Belga K285 JL
- Beckton Julian GG B571
- Beckton Belga G493 HR

BWt	58
WR	105
YWt.	1027
YR	102
FebADG	3.44
Frame	5.0
Feet	Good

DAM	
Age	6
Wt	1150
Prog. BW	56
WR	96
YR	94
Udder	Very Good
Wean Pct.	43%
Cow Eff.	90

Calv.Ease	BW	WW	YW	Milk	HPG	Stay	Maint.En.
EPDs	18	-4.7	51	75	27	14	-6.0
Marb	+0.37		REA	+0.00		Bfat +0.02	
Beef Tenderness	→ DNA: NA / NA		Scan: 1.5 / Tender +				
HerdBuilder Index:	93	Pct.: 3%	ProS:	112	Pct.: 21%		

★★★★★ for Low Maintenance, Marbling, Calving Ease.



### 135 WCRA Likable K206

A 100% # 4659667 Tat: WCRA2K206



Birth: 3-22-22

- Beckton Likable Z057 L4
- Beckton Likable X445 J3
- Beckton Likable B032 C5
- Beckton Minola X107 L
- Beckton Mona Z270 C
- Beckton Clifftop W577 E3
- Beckton Accent W180 C2
- Beckton Mona U584 CD
- Beckton Christy F136 A
- Beckton Cody K1 P014
- Beckton Christy B001 N
- Beckton Christy R046 CQ
- Beckton Nebula P P707
- Beckton Christy Z390 J

BWt	59
WR	99
YWt.	930
YR	101
FebADG	NA
Frame	5.0
Feet	Good

DAM	
Age	4
Wt	1085
Prog. BW	53
WR	95
YR	101
Udder	Very Good
Wean Pct.	46%
Cow Eff.	NA

Calv.Ease	BW	WW	YW	Milk	HPG	Stay	Maint.En.
EPDs	18	-4.9	57	108	24	15	16
Marb	+0.49		REA	+0.06		Bfat +0.04	
Beef Tenderness	→ DNA: NA / NA		Scan: 1.7 / Tender				
HerdBuilder Index:	49	Pct.: 17%	ProS:	113	Pct.: 20%		

★★★★★ for Marbling, Calving Ease.

### 133 BSF Scamp K206 L6

1-B 99% # 4676539 Tat: BSF2 K206



Birth: 3-13-22

- Beckton Scamp B720 L4
- Beckton Scamp X458 H3
- Beckton Scamp E175 N5
- Beckton Larkaba Y448 L
- Beckton Belga W103 N
- Beckton Nebula T398 V3
- Beckton Belga T551 EP
- Beckton Loki X833 H4
- Beckton Loki CL S284
- Beckton Vernice T447 HT
- Beckton Lanette D532 L
- Beckton Cherokee N N479
- BSF Lanette U463 CQ
- BSF Lanette R748 LN

BWt	60
WR	99
YWt.	929
YR	93
FebADG	3.81
Frame	5.0
Feet	Good

DAM	
Age	6
Wt	1055
Prog. BW	59
WR	101
YR	97
Udder	Very Good
Wean Pct.	46%
Cow Eff.	96

Calv.Ease	BW	WW	YW	Milk	HPG	Stay	Maint.En.
EPDs	19	-6.2	51	83	29	9	5.0
Marb	+0.42		REA	-0.07		Bfat +0.03	
Beef Tenderness	→ DNA: 9 / Outstanding		Scan: 1.4 / Tender +				
HerdBuilder Index:	51	Pct.: 58%	ProS:	86	Pct.: 61%		

★★★★★ for Gainability, Marbling, Calving Ease.

### 136 Beckton Heritage K205 L6

1-A 100% # 4676939 Tat: BSF2 K205



Birth: 3-13-22

- Beckton Heritage C477 J4
- Beckton Heritage X403 L3
- Beckton Heritage H181 N5
- Beckton Ruth Z858 J
- Beckton Sierra Y441 N
- Beckton Nebula T269 E2
- Beckton Likable Y124 L3
- Beckton Sierra S120 HW
- Beckton Belga H388 L
- Beckton Likable U130 L2
- Beckton BKT Pine Marie S802 L0
- Beckton Julian Z382 J7
- Beckton Belga D455 J
- Beckton Belga M050 EP

BWt	61
WR	105
YWt.	944
YR	96
FebADG	3.06
Frame	5.0
Feet	Good

DAM	
Age	2
Wt	820
Prog. BW	61
WR	105
YR	96
Udder	Very Good
Wean Pct.	50%
Cow Eff.	106

Calv.Ease	BW	WW	YW	Milk	HPG	Stay	Maint.En.
EPDs	17	-4.5	55	84	33	13	-2.0
Marb	+0.34		REA	-0.08		Bfat +0.04	
Beef Tenderness	→ DNA: 10 / Outstanding		Scan: 1.4 / Tender +				
HerdBuilder Index:	84	Pct.: 6%	ProS:	100	Pct.: 38%		

★★★★★ for Low Maintenance, Marbling, Calving Ease.

\*Note: Scrotal and ultrasound data will be available later



Lot 139

## 139 BSF Accent K309 L6

1-B 99% # 4676941 Tat: BSF2 K309



Birth: 3-20-22

Beckton Accent H121 H5  
Ref. A-8

Beckton Accent F363 L4  
Beckton Christy F670 H

Beckton Likable B032 C5  
BSF Laurel Z246 L

Beckton Accent B549 N3  
Beckton Coca B062 L  
Beckton Heritage B612 J4  
Beckton Christy Z229 N  
Beckton Likable Z057 L4  
Beckton Mona Z270 C  
Beckton Loki X833 H4  
BSF Laurel X098 W

BWt	58
WR	104
YWt	1113
YR	115
FebADG	4.06
Frame	5.0
Feet	Good

DAM		Calv.Ease	BW	WW	YW	Milk	HPG	Stay	Maint.En.
Age	2	EPDs	17	-3.9	62	109	28	13	13
Wt	880	Marb	+0.44		REA	+0.12		Bfat	+0.04
Prog. BW	58	Beef Tenderness	→ DNA: 9 / Outstanding		Scan:	2.4 / Tender			
WR	104	HerdBuilder Index:	40	Pct.: 79%	ProS:	89	Pct.: 56%		
YR	115	★★★★★ for Growth, Gainability, Marbling, Superior Cow, Calving Ease.							
Udder	Very Good								
Wean Pct.	43%								
Cow Eff.	91								

## 137 Beckton Nebula K178 J6

1-A 100% # 4676105 Tat: BKT2 K178



Birth: 3-9-22

Beckton Nebula H566 L5  
Ref. N-5

Beckton Nebula T398 V3  
Beckton Mona X022 L  
Beckton Likable A306 L3  
Beckton Maiata A091 C

Beckton Julian E423 N8  
Beckton Suffeina H512 J

Beckton Julian Z382 J7  
Beckton Belga B004 N  
Beckton Accent U777 C2  
Beckton Suffeina A190 A

BWt	60
WR	104
YWt	998
YR	101
FebADG	3.50
Frame	5.0
Feet	Good

DAM		Calv.Ease	BW	WW	YW	Milk	HPG	Stay	Maint.En.
Age	2	EPDs	15	-3.3	59	96	31	NA	20
Wt	820	Marb	+0.39		REA	-0.05		Bfat	+0.04
Prog. BW	60	Beef Tenderness	→ DNA: 10 / Outstanding		Scan:	1.3 / Tender +			
WR	104	HerdBuilder Index:	74	Pct.: 17%	ProS:	108	Pct.: 26%		
YR	101	★★★★★ for Gainability, Marbling, Calving Ease.							
Udder	Very Good								
Wean Pct.	50%								
Cow Eff.	105								

## 140 Beckton Julian K529 E8

1-A 100% # 4675753 Tat: BKT2 K529



Birth: 4-3-22

Beckton Julian Z382 J7  
Ref. J-2

Beckton Julian X721 E6  
Beckton Larkaba X064 J

Beckton Epic D002 E8  
Beckton Pine Marie F104 E

Beckton Julian U699 L5  
Beckton Lana U329 EP  
Beckton Julian U699 L5  
Beckton Larkaba U475 CT  
Beckton Epic B545 N7  
Beckton Christy B701 E  
Beckton Epic B545 N7  
Beckton Pine Marie B170 L

BWt	51
WR	92
YWt	1020
YR	101
FebADG	3.56
Frame	5.0
Feet	Good

DAM		Calv.Ease	BW	WW	YW	Milk	HPG	Stay	Maint.En.
Age	4	EPDs	21	-7.5	52	89	28	13	18
Wt	835	Marb	+0.35		REA	+0.07		Bfat	+0.05
Prog. BW	54	Beef Tenderness	→ DNA: 7 / Very Good		Scan:	2.2 / Tender			
WR	96	HerdBuilder Index:	88	Pct.: 5%	ProS:	119	Pct.: 13%		
YR	100	★★★★★ for Low Maintenance, Gainability, Marbling, Calving Ease.							
Udder	Very Good								
Wean Pct.	49%								
Cow Eff.	104								

## 138 Beckton Heritage K068 A6

1-A 100% # 4676265 Tat: BKT2 K068



Birth: 2-21-22

Beckton Heritage H181 N5  
Ref. H-2

Beckton Heritage C477 J4  
Beckton Sierra Y441 N  
Beckton Accent F895 E3  
Beckton Coca H070 A

Beckton Heritage X403 L3  
Beckton Ruth Z858 J  
Beckton Nebula T269 E2  
Beckton Sierra S120 HW  
Beckton Accent B553 L2  
Beckton Indigo U504 EP  
Beckton Clifftop D059 C5  
Beckton Coca D081 N

BWt	56
WR	104
YWt	942
YR	97
FebADG	2.56
Frame	5.0
Feet	Good

DAM		Calv.Ease	BW	WW	YW	Milk	HPG	Stay	Maint.En.
Age	2	EPDs	13	-4.1	56	90	31	NA	16
Wt	785	Marb	+0.34		REA	-0.09		Bfat	+0.03
Prog. BW	56	Beef Tenderness	→ DNA: 10 / Outstanding		Scan:	1.5 / Tender +			
WR	104	HerdBuilder Index:	49	Pct.: 64%	ProS:	69	Pct.: 84%		
YR	97	★★★★★ for Low Maintenance, Marbling, Calving Ease.							
Udder	Very Good								
Wean Pct.	48%								
Cow Eff.	102								

## 141 Beckton Accent K133 L6

1-A 100% # 4677007 Tat: BSF2 K133



Birth: 3-4-22

Beckton Accent H059 N5  
Ref. A-7

Beckton Accent F363 L4  
Beckton Encino F751 N

Beckton Likable F682 S5  
Beckton Lana H102 L

Beckton Accent B549 N3  
Beckton Coca B062 L  
Beckton Nebula X603 J4  
Beckton Encino A442 J  
Beckton Likable Z057 L4  
Beckton Lana C073 S  
Beckton Accent B150 N4  
Beckton Lana W113 N

BWt	63
WR	88
YWt	1039
YR	106
FebADG	3.73
Frame	5.0
Feet	Good

DAM		Calv.Ease	BW	WW	YW	Milk	HPG	Stay	Maint.En.
Age	2	EPDs	17	-4.5	59	107	24	NA	16
Wt	765	Marb	+0.38		REA	+0.03		Bfat	+0.04
Prog. BW	63	Beef Tenderness	→ DNA: 10 / Outstanding		Scan:	1.8 / Tender			
WR	88	HerdBuilder Index:	57	Pct.: 46%	ProS:	111	Pct.: 22%		
YR	106	★★★★★ for Growth, Gainability, Marbling, Calving Ease.							
Udder	Very Good								
Wean Pct.	44%								
Cow Eff.	92								

\*Note: Scrotal and ultrasound data will be available later

## 142 Beckton Nebula K855 S5

1-A 100% # 4675315 Tat: BKT2 K855



Birth: 5-5-22

Beckton Nebula T398 V3 < Beckton Nebula L P093  
Beckton Minerva J615 VG

**Beckton Nebula A773 L4**

Ref. N-2 < Beckton Mona X022 L < Beckton Likable U130 L2  
Beckton Mona U584 CD

Beckton Scamp X494 E3 < Beckton Scamp T A825  
Beckton Lana S074 EP

**Beckton Serena C296 S**

< Beckton Warrior T248 L5  
Beckton Serena N088 WR

BWt	63
WR	106
YWt.	1041
YR	105
FebADG	3.17
Frame	5.0
Feet	Good

DAM		Calv.Ease	BW	WW	YW	Milk	HPG	Stay	Maint.En.	
Age	7	EPDs	16	-4.6	51	81	31	14	21	-3.0
Wt	1000	Marb	+0.32		REA	-0.13		Bfat	+0.03	
Prog. BW	65	Beef Tenderness →	DNA: 10 / Outstanding		Scan:	2.0 / Tender				
WR	109	HerdBuilder Index:	103	Pct.: 1%	ProS:	128	Pct.: 7%			
YR	104	★★★★★ for Low Maintenance, Marbling, Superior Cow, Calving Ease.								
Udder	Very Good									
Wean Pct.	52%									
Cow Eff.	109									

## 144 Beckton Accent K815 H5

1-A 100% # 4676741 Tat: BSF2 K815



Birth: 4-29-22

Beckton Accent E172 L3 < Beckton Accent W180 C2  
Beckton Indigo Y406 L

**Beckton Accent G107 C4**

Ref. A-5 < Beckton Pine Marie E206 D < TR Double Eagle ZT220  
BKT Pine Marie W404 J

Beckton Heritage B612 J4 < Beckton Heritage X403 L3  
Beckton Lana N291 JC

**Beckton Encino F087 H**

< Beckton Legend S670  
Beckton Encino S059 JT

BWt	72
WR	100
YWt.	1085
YR	109
FebADG	4.16
Frame	5.0
Feet	Good

DAM		Calv.Ease	BW	WW	YW	Milk	HPG	Stay	Maint.En.	
Age	4	EPDs	18	-5.0	59	92	31	13	16	-6.0
Wt	905	Marb	+0.44		REA	+0.13		Bfat	+0.03	
Prog. BW	68	Beef Tenderness →	DNA: 9 / Outstanding		Scan:	1.8 / Tender				
WR	110	HerdBuilder Index:	75	Pct.: 15%	ProS:	120	Pct.: 13%			
YR	99	★★★★★ for Low Maintenance, Growth, Gainability, Marbling, Rib-eye area, Calving Ease.								
Udder	Very Good									
Wean Pct.	51%									
Cow Eff.	108									

## 143 Beckton Julian K410 N8

1-A 100% # 4675195 Tat: BKT2 K410



Birth: 3-27-22

Beckton Julian D551 C6 < Beckton Julian X465 J5  
Beckton Tamara W550 A

**Beckton Julian F067 L7**

Ref. J-4 < Beckton Indigo D786 L < Beckton Likable Z057 L4  
Beckton Indigo Y026 N

Beckton Nebula X096 N4 < Beckton Nebula U206 V3  
Beckton Tamara U185 NB

**Beckton Sierra Z059 N**

< Beckton Cherokee T450 L3  
Beckton Sierra G615 WR

BWt	82
WR	81
YWt.	1017
YR	102
FebADG	3.95
Frame	4.5
Feet	Good

DAM		Calv.Ease	BW	WW	YW	Milk	HPG	Stay	Maint.En.	
Age	10	EPDs	13	0.0	60	117	23	13	15	16.0
Wt	1360	Marb	+0.52		REA	-0.02		Bfat	+0.03	
Prog. BW	83	Beef Tenderness →	DNA: 7 / Very Good		Scan:	1.5 / Tender +				
WR	106	HerdBuilder Index:	23	Pct.: 95%	ProS:	90	Pct.: 54%			
YR	109	★★★★★ for Gainability, Marbling, Superior Cow, Calving Ease.								
Udder	Good									
Wean Pct.	29%									
Cow Eff.	61									



Lot 145



Lot 141

## 145 Beckton Scamp K238 E6

1-A 100% # 4675819 Tat: BKT2 K238



Birth: 3-16-22

Beckton Scamp B720 L4 < Beckton Scamp X458 H3  
Beckton Larkaba Y448 L

**Beckton Scamp E175 N5**

Ref. S-1 < Beckton Belga W103 N < Beckton Nebula T398 V3  
Beckton Belga T551 EP

Beckton Epic D275 L7 < Beckton Epic Z674 E6  
Beckton Lana X839 L

**Beckton Christy G127 E**

< Beckton Julian X721 E6  
Beckton Christy X354 N

BWt	55
WR	89
YWt.	1017
YR	104
FebADG	3.33
Frame	5.0
Feet	Good

DAM		Calv.Ease	BW	WW	YW	Milk	HPG	Stay	Maint.En.	
Age	3	EPDs	19	-6.2	51	92	27	10	16	4.0
Wt	860	Marb	+0.36		REA	-0.08		Bfat	+0.04	
Prog. BW	53	Beef Tenderness →	DNA: 9 / Outstanding		Scan:	1.6 / Tender +				
WR	93	HerdBuilder Index:	52	Pct.: 57%	ProS:	97	Pct.: 42%			
YR	100	★★★★★ for Marbling, Calving Ease.								
Udder	Very Good									
Wean Pct.	44%									
Cow Eff.	93									

\*Note: Scrotal and ultrasound data will be available later

## 146 Beckton Scamp K242 D7

1-A 100% # 4676191 Tat: BKT2 K242

Birth: 3-17-22

Beckton Scamp E175 N5  
 Beckton Scamp B720 L4  
 Beckton Belga W103 N

**Beckton Scamp H215 L6**  
 Ref. S BKT Pine Marie Z194 L  
 Beckton Likable X445 J3  
 BKT Pine Marie X339 N

Beckton Dominor D254 N8  
 Beckton Indigo W772 N

**Beckton Kit H222 D**  
 Beckton Kit Z554 C  
 Beckton Clifftop W692 E3  
 Beckton Kit S271 JL

BWt	65
WR	103
YWt.	995
YR	101
FebADG	3.05
Frame	5.0
Feet	Good

DAM	
Age	2
Wt	830
Prog. BW	65
WR	103
YR	101
Udder	Very Good
Wean Pct.	49%
Cow Eff.	103

Calv.Ease	BW	WW	YW	Milk	HPG	Stay	Maint.En.	
EPDs	16	-4.0	52	84	31	11	15	1.0
Marb	+0.45		REA +0.3		Bfat +0.04			
Beef Tenderness	→ DNA: 10 / Outstanding		Scan: 2.0 / Tender					
HerdBuilder Index:	51	Pct.: 59%	ProS: 85		Pct.: 62%			

★★★★★ for Marbling, Calving Ease.

## 149 Beckton Epic K079 E9

1-A 100% # 4676927 Tat: BSF2 K079

Birth: 2-23-22

Beckton Epic D001 L7  
 Beckton Epic B483 N6  
 Beckton Mona B713 L

**Beckton Epic H335 A8**  
 Ref. E-3 Beckton Coca D239 A  
 Beckton Accent W180 C2  
 Beckton Coca T454 NX

Beckton Epic D001 L7  
 Beckton Mona B713 L

**Beckton Minola H461 E**  
 Beckton Minola B292 N  
 Beckton New Era Y194  
 Beckton Minola N751 JL

BWt	45
WR	92
YWt.	1028
YR	104
FebADG	3.68
Frame	4.5
Feet	Good

DAM	
Age	2
Wt	1020
Prog. BW	45
WR	92
YR	104
Udder	NA
Wean Pct.	35%
Cow Eff.	73

Calv.Ease	BW	WW	YW	Milk	HPG	Stay	Maint.En.	
EPDs	19	-6.8	56	103	28	NA	18	3.0
Marb	+0.37		REA +0.05		Bfat +0.05			
Beef Tenderness	→ DNA: 10 / Outstanding		Scan: 1.8 / Tender					
HerdBuilder Index:	71	Pct.: 21%	ProS: 125		Pct.: 9%			

★★★★★ for Gainability, Marbling, Calving Ease.

## 147 Beckton Likable K771 E5

1-A 100% # 4675917 Tat: BKT2 K771

Birth: 4-24-22

Beckton Likable C229 R3  
 Beckton Likable U130 L2  
 Beckton Tamara X447 J

**Beckton Likable G403 N4**  
 Ref. L-6 Beckton Minerva Y385 N  
 Beckton Nebula T398 V3  
 Beckton Minerva U310 L0

Beckton Epic B310 J6  
 Beckton Epic X464 L5  
 Beckton Minerva Y116 J

**Beckton Kit G443 E**  
 Beckton Kit D126 A  
 Beckton Accent U777 C2  
 Beckton Kit Z049 N

BWt	60
WR	109
YWt.	1054
YR	108
FebADG	3.36
Frame	5.5
Feet	Good

DAM	
Age	3
Wt	850
Prog. BW	59
WR	108
YR	106
Udder	Very Good
Wean Pct.	55%
Cow Eff.	116

Calv.Ease	BW	WW	YW	Milk	HPG	Stay	Maint.En.	
EPDs	19	-6.0	59	94	31	12	17	0.0
Marb	+0.29		REA +0.11		Bfat +0.04			
Beef Tenderness	→ DNA: 10 / Outstanding		Scan: 1.9 / Tender					
HerdBuilder Index:	80	Pct.: 10%	ProS: 103		Pct.: 33%			

★★★★★ for Low Maintenance, Growth, Marbling, Superior Cow, Cow Efficiency, Calving Ease.

## 150 Beckton Nebula K660 N6

1-A 100% # 4676173 Tat: BKT2 K660

Birth: 4-12-22

Beckton Nebula A773 L4  
 Beckton Nebula T398 V3  
 Beckton Mona X022 L

**Beckton Nebula H566 L5**  
 Ref. N-5 Beckton Maiata C031 L  
 Beckton Likable A306 L3  
 Beckton Maiata A091 C

Beckton Nebula A773 L4  
 Beckton Nebula T398 V3  
 Beckton Mona X022 L

**Beckton Serena H269 N**  
 Beckton Serena A269 D  
 Beckton Dominor Y005 V6  
 Beckton Serena Y044 E

BWt	63
WR	110
YWt.	1016
YR	103
FebADG	3.31
Frame	5.5
Feet	Good

DAM	
Age	2
Wt	900
Prog. BW	63
WR	110
YR	103
Udder	Very Good
Wean Pct.	48%
Cow Eff.	102

Calv.Ease	BW	WW	YW	Milk	HPG	Stay	Maint.En.	
EPDs	15	-3.1	62	98	32	NA	21	5.0
Marb	+0.38		REA +0.09		Bfat +0.04			
Beef Tenderness	→ DNA: 10 / Outstanding		Scan: 1.5 / Tender +					
HerdBuilder Index:	86	Pct.: 5%	ProS: 122		Pct.: 11%			

★★★★★ for Marbling, Superior Cow, Calving Ease.

## 148 Beckton Dominor K574 R9

1-A 100% # 4675785 Tat: BKT2 K574

Birth: 4-5-22

Beckton Dominor A378 W7  
 Beckton Dominor Y005 V6  
 Beckton Lana Y541 W

**Beckton Dominor F263 N8**  
 Ref. D-1 Beckton Larkaba W272 N  
 Beckton Nebula EN S347  
 Beckton Larkaba N643 HR

Beckton Ranger B006 D5  
 Beckton Ranger Z225 J4  
 Beckton Suffeina Z731 D

**Beckton Larkaba G241 R**  
 Beckton Larkaba X549 L  
 Beckton Loki CL S284  
 Beckton Larkaba R615 JE

BWt	66
WR	101
YWt.	1025
YR	105
FebADG	3.52
Frame	5.5
Feet	Good

DAM	
Age	3
Wt	920
Prog. BW	61
WR	104
YR	104
Udder	Very Good
Wean Pct.	47%
Cow Eff.	99

Calv.Ease	BW	WW	YW	Milk	HPG	Stay	Maint.En.	
EPDs	18	-3.5	56	92	32	13	15	2.0
Marb	+0.47		REA +0.04		Bfat +0.05			
Beef Tenderness	→ DNA: 10 / Outstanding		Scan: 1.8 / Tender					
HerdBuilder Index:	57	Pct.: 46%	ProS: 100		Pct.: 38%			

★★★★★ for Gainability, Marbling, Superior Cow, Calving Ease.

## 151 Beckton Accent K953 H4

1-A 100% # 4675545 Tat: BSF2 K953

Birth: 6-11-22

Beckton Accent W180 C2  
 Beckton Cody K1 P014  
 Beckton Christy R046 CQ

**Beckton Accent B549 N3**  
 Ref. A-2 Beckton Minerva Y654 N  
 Beckton Nebula T398 V3  
 Beckton Minerva M369 LO

Beckton Hasten Y069 D4  
 Beckton Hasten U108 J3  
 Beckton Marta P484 DM

**Beckton Mona E460 H**  
 Beckton Mona A671 J  
 Beckton Julian G5 S107  
 Beckton Mona S621 LN

BWt	NA
WR	133
YWt.	1187
YR	119
FebADG	3.58
Frame	5.5
Feet	Good

DAM	
Age	5
Wt	1190
Prog. BW	61
WR	107
YR	118
Udder	Very Good
Wean Pct.	54%
Cow Eff.	114

Calv.Ease	BW	WW	YW	Milk	HPG	Stay	Maint.En.	
EPDs	15	-3.3	70	120	24	11	13	6.0
Marb	+0.45		REA +0.08		Bfat +0.04			
Beef Tenderness	→ DNA: 7 / Very Good		Scan: 2.1 / Tender					
HerdBuilder Index:	24	Pct.: 95%	ProS: 74		Pct.: 78%			

★★★★★ for Growth, Gainability, Marbling, Superior Cow, Calving Ease.

\*Note: Scrotal and ultrasound data will be available later

## 152 Beckton Accent K435 E5

1-A 100% # 4677005 Tat: BSF2 K435

Birth: 3-29-22

Beckton Accent B549 N3 < Beckton Accent W180 C2  
Beckton Minerva Y654 N

**Beckton Accent H410 A4**

Ref. A-9 < Beckton Minola C198 A < Beckton Accent A485 C3  
Beckton Minola A330 S

Beckton Epic F279 A7 < Beckton Epic Z674 E6  
Beckton Firefly B511 A

**Beckton Christy H105 E**

< Beckton Epic Z674 E6  
Beckton Christy Z191 N

BWt **45**

WR **111**

YWt. **999**

YR **101**

FebADG **2.69**

Frame **5.0**

Feet **Good**

DAM		Calv.Ease	BW	WW	YW	Milk	HPG	Stay	Maint.En.	
Age	2	EPDs	17	-4.7	58	93	29	NA	16	1.0
Wt	700	Marb	+3.5		REA	+1.5		Bfat	+0.5	
Prog. BW	45	Beef Tenderness	→		DNA	NA / NA		Scan	1.5 / Tender +	
WR	111	HerdBuilder Index	56	Pct.	49%		ProS	77	Pct.: 75%	
YR	101	★★★★★ for Marbling, Rib-eye area, Cow Efficiency, Calving Ease.								
Udder	Very Good									
Wean Pct.	63%									
Cow Eff.	132									

## 155 Beckton Dominor K570 H9

1-A 100% # 4675955 Tat: BKT2 K570

Birth: 4-5-22

Beckton Dominor A378 W7 < Beckton Dominor Y005 V6  
Beckton Lana Y541 W

**Beckton Dominor F263 N8**

Ref. D-1 < Beckton Larkaba W272 N < Beckton Nebula EN S347  
Beckton Larkaba N643 HR

Beckton Hughes E261 S3 < Beckton Hughes C463 N2  
Beckton Lana C073 S

**Beckton Serena G240 H**

< Beckton Clifftop B079 C5  
Beckton Serena A761 A

BWt **68**

WR **106**

YWt. **1030**

YR **105**

FebADG **NA**

Frame **5.0**

Feet **Good**

DAM		Calv.Ease	BW	WW	YW	Milk	HPG	Stay	Maint.En.	
Age	3	EPDs	18	-3.5	60	99	31	14	16	-1.0
Wt	885	Marb	+4.8		REA	+1.0		Bfat	+0.5	
Prog. BW	59	Beef Tenderness	→		DNA	7 / Very Good		Scan	1.6 / Tender +	
WR	104	HerdBuilder Index	72	Pct.	19%		ProS	112	Pct.: 21%	
YR	103	★★★★★ for Low Maintenance, Growth, Marbling, Superior Cow, Calving Ease.								
Udder	Very Good									
Wean Pct.	51%									
Cow Eff.	108									

## 153 Beckton Jet K651 E3

1-A 100% # 4675767 Tat: BKT2 K651

Birth: 4-12-22

Beckton Jet L P491 < TR Julian Lt151  
Beckton Minerva L278 LN

**Beckton Jet G441 N2**

Ref. J-5 < Beckton Susan B246 N < Beckton New Era Y194  
Beckton Susan R022 CQ

Beckton Epic D002 E8 < Beckton Epic B545 N7  
Beckton Christy B701 E

**Beckton Christy F009 E**

< Beckton Nebula B620 E5  
Beckton Christy B471 N

BWt **61**

WR **108**

YWt. **1028**

YR **103**

FebADG **3.25**

Frame **5.0**

Feet **Good**

DAM		Calv.Ease	BW	WW	YW	Milk	HPG	Stay	Maint.En.	
Age	4	EPDs	20	-7.1	55	90	32	12	18	0.0
Wt	1000	Marb	+4.8		REA	+0.8		Bfat	+0.4	
Prog. BW	70	Beef Tenderness	→		DNA	7 / Very Good		Scan	1.5 / Tender +	
WR	110	HerdBuilder Index	77	Pct.	12%		ProS	116	Pct.: 16%	
YR	103	★★★★★ for Low Maintenance, Marbling, Superior Cow, Calving Ease.								
Udder	Very Good									
Wean Pct.	50%									
Cow Eff.	106									

## 156 Beckton Dominor K432 L9

1-A 100% # 4676809 Tat: BSF2 K432

Birth: 3-29-22

Beckton Dominor A378 W7 < Beckton Dominor Y005 V6  
Beckton Lana Y541 W

**Beckton Dominor F263 N8**

Ref. D-1 < Beckton Larkaba W272 N < Beckton Nebula EN S347  
Beckton Larkaba N643 HR

Beckton Likable B032 C5 < Beckton Likable Z057 L4  
Beckton Mona Z270 C

**Beckton Lana G572 L**

< Beckton Scamp A627 J4  
Beckton Lana A574 N

BWt **64**

WR **109**

YWt. **1032**

YR **105**

FebADG **3.19**

Frame **5.0**

Feet **Good**

DAM		Calv.Ease	BW	WW	YW	Milk	HPG	Stay	Maint.En.	
Age	3	EPDs	19	-3.8	58	100	31	14	14	5.0
Wt	1055	Marb	+5.0		REA	+1.1		Bfat	+0.4	
Prog. BW	57	Beef Tenderness	→		DNA	9 / Outstanding		Scan	1.3 / Tender +	
WR	104	HerdBuilder Index	53	Pct.	56%		ProS	98	Pct.: 41%	
YR	106	★★★★★ for Growth, Marbling, Superior Cow, Calving Ease.								
Udder	Very Good									
Wean Pct.	42%									
Cow Eff.	88									

## 154 Beckton Scamp K181 S7

1-A 100% # 4676149 Tat: BKT2 K181

Birth: 3-10-22

Beckton Scamp F172 N5 < Beckton Scamp B720 L4  
Beckton Angel X450 N

**Beckton Scamp H076 E6**

Ref. S-4 < Beckton Larkaba F349 E < Beckton Epic B310 J6  
Beckton Larkaba B409 L

Beckton Scamp B720 L4 < Beckton Scamp B720 L4  
Beckton Belga W103 N

**Beckton Pine Marie H365 S**

< Beckton Epic X330 L6  
BKT Pine Marie X688 N

BWt **49**

WR **113**

YWt. **1016**

YR **105**

FebADG **3.28**

Frame **5.0**

Feet **Good**

DAM		Calv.Ease	BW	WW	YW	Milk	HPG	Stay	Maint.En.	
Age	2	EPDs	19	-5.2	65	106	31	NA	15	9.0
Wt	870	Marb	+3.4		REA	+1.1		Bfat	+0.3	
Prog. BW	49	Beef Tenderness	→		DNA	10 / Outstanding		Scan	1.1 / Tender +	
WR	113	HerdBuilder Index	48	Pct.	65%		ProS	81	Pct.: 68%	
YR	105	★★★★★ for Marbling, Superior Cow, Calving Ease.								
Udder	Very Good									
Wean Pct.	48%									
Cow Eff.	101									

## 157 BSF Scamp K300 A6

1-B 99% # 4676853 Tat: BSF2 K300

Birth: 3-20-22

Beckton Scamp B720 L4 < Beckton Scamp X458 H3  
Beckton Larkaba Y448 L

**Beckton Scamp E175 N5**

Ref. S-1 < Beckton Belga W103 N < Beckton Nebula T398 V3  
Beckton Belga T551 EP

Beckton Accent E172 L3 < Beckton Accent W180 C2  
Beckton Indigo Y406 L

**BSF Codette G042 A**

< Beckton Epic C776 J6  
BSF Codette C582 S

BWt **62**

WR **111**

YWt. **975**

YR **100**

FebADG **2.94**

Frame **5.0**

Feet **Good**

DAM		Calv.Ease	BW	WW	YW	Milk	HPG	Stay	Maint.En.	
Age	3	EPDs	17	-4.7	53	87	31	11	17	5.0
Wt	870	Marb	+3.8		REA	+0.6		Bfat	+0.3	
Prog. BW	64	Beef Tenderness	→		DNA	9 / Outstanding		Scan	1.5 / Tender +	
WR	115	HerdBuilder Index	60	Pct.	40%		ProS	83	Pct.: 65%	
YR	106	★★★★★ for Marbling, Superior Cow, Cow Efficiency, Calving Ease.								
Udder	Very Good									
Wean Pct.	55%									
Cow Eff.	116									

\*Note: Scrotal and ultrasound data will be available later

## 158 Beckton Scamp K575 C7

1-A 100% # 4675557 Tat: BKT2 K575

Birth: 4-5-22

Beckton Scamp E175 N5 < Beckton Scamp B720 L4  
Beckton Belga W103 N

**Beckton Scamp G006 C6**

Ref. S-2 < Beckton Firefly E769 C < Beckton Cardinal B074 N  
Beckton Firefly B052 W

Beckton Cardinal B074 N < TR Double Eagle ZT220  
BKT Pine Marie Z250 N

**Beckton Pine Marie E424 C**

Beckton Pine Marie A074 C < Beckton Clifftop W692 E3  
BKT Pine Marie X596 N

BWt **61**

WR **99**

YWt. **990**

YR **98**

FebADG **3.53**

Frame **4.5**

Feet **Good**

DAM		Calv.Ease	BW	WW	YW	Milk	HPG	Stay	Maint.En.	
Age	5	EPDs	21	-7.8	50	92	27	9	17	6.0
Wt	1000	Marb	+0.33		REA	-0.04		Bfat	+0.03	
Prog. BW	70	Beef Tenderness →	DNA: 7 / Very Good		Scan:	1.7 / Tender				
WR	100	HerdBuilder Index:	55	Pct.: 51%	ProS:	99	Pct.: 39%			
YR	105	★★★★★ for Gainability, Marbling, Calving Ease.								
Udder	Very Good									
Wean Pct.	46%									
Cow Eff.	98									

## 161 BSF Oracle K641 D2

1-B 99% # 4676503 Tat: BSF2 K641

Birth: 4-11-22

Schuler Sudden Impact 0004X < Red Crowfoot Ole's Oscar  
SOR Duchess TS 8915U

**Schuler Oracle-7142E**

Ref. 0-2 < Sor Marlee Cmmmtnt 0470X < Brown Commitment S7206  
SOR Marlee Beef 4511P

Beckton Dominor A378 W7 < Beckton Dominor Y005 V6  
Beckton Lana Y541 W

**BSF Loketta D440 D**

BSF Loketta A119 N < Beckton Nebula Y002 C5  
BSF Loketta Y361 A

BWt **72**

WR **102**

YWt. **1007**

YR **101**

FebADG **3.50**

Frame **5.0**

Feet **Good**

DAM		Calv.Ease	BW	WW	YW	Milk	HPG	Stay	Maint.En.	
Age	6	EPDs	19	-4.3	53	92	23	12	16	-1.0
Wt	1070	Marb	+0.66		REA	+0.19		Bfat	+0.03	
Prog. BW	71	Beef Tenderness →	DNA: 9 / Outstanding		Scan:	1.5 / Tender +				
WR	95	HerdBuilder Index:	71	Pct.: 20%	ProS:	135	Pct.: 4%			
YR	96	★★★★★ for Low Maintenance, Gainability, Marbling, Rib-eye area, Calving Ease.								
Udder	Fair									
Wean Pct.	46%									
Cow Eff.	97									

## 159 Beckton Scamp K252 E6

1-A 100% # 4675909 Tat: BKT2 K252

Birth: 3-17-22

Beckton Scamp B720 L4 < Beckton Scamp X458 H3  
Beckton Larkaba Y448 L

**Beckton Scamp E175 N5**

Ref. S-1 < Beckton Belga W103 N < Beckton Nebula T398 V3  
Beckton Belga T551 EP

Beckton Epic D275 L7 < Beckton Epic Z674 E6  
Beckton Lana X839 L

**Beckton Tamara G293 E**

Beckton Tamara D822 L < Beckton Likable Y362 L3  
Beckton Tamara T111 CQ

BWt **60**

WR **110**

YWt. **965**

YR **98**

FebADG **NA**

Frame **5.0**

Feet **Good**

DAM		Calv.Ease	BW	WW	YW	Milk	HPG	Stay	Maint.En.	
Age	3	EPDs	19	-6.0	52	86	31	9	15	3.0
Wt	880	Marb	+0.33		REA	-0.01		Bfat	+0.03	
Prog. BW	57	Beef Tenderness →	DNA: 7 / Very Good		Scan:	2.2 / Tender				
WR	110	HerdBuilder Index:	48	Pct.: 65%	ProS:	69	Pct.: 85%			
YR	98	★★★★★ for Marbling, Calving Ease.								
Udder	Very Good									
Wean Pct.	51%									
Cow Eff.	107									

## 162 BSF Nebula K656 N5

1-B 99% # 4676487 Tat: BSF2 K656

Birth: 4-12-22

Beckton Nebula T398 V3 < Beckton Nebula L P093  
Beckton Minerva J615 VG

**Beckton Nebula A773 L4**

Ref. N-2 < Beckton Mona X022 L < Beckton Likable U130 L2  
Beckton Mona U584 CD

Beckton New Era A409 N2 < Beckton New Era Y194  
Beckton Eola W796 N

**BSF Hustle C852 N**

BSF Hustle P748 < Beckton Hustler CN J102  
WF Regus H107

BWt **74**

WR **96**

YWt. **980**

YR **98**

FebADG **3.38**

Frame **5.0**

Feet **Good**

DAM		Calv.Ease	BW	WW	YW	Milk	HPG	Stay	Maint.En.	
Age	7	EPDs	13	-2.6	59	96	31	13	21	2.0
Wt	1320	Marb	+0.23		REA	+0.04		Bfat	+0.03	
Prog. BW	70	Beef Tenderness →	DNA: 10 / Outstanding		Scan:	1.8 / Tender				
WR	107	HerdBuilder Index:	84	Pct.: 7%	ProS:	113	Pct.: 19%			
YR	105	★★★★★ for Marbling, Superior Cow, Calving Ease.								
Udder	Good									
Wean Pct.	35%									
Cow Eff.	74									

## 160 Beckton Julian K840 W8

1-A 100% # 4676485 Tat: BSF2 K840

Birth: 5-1-22

Beckton Julian D551 C6 < Beckton Julian X465 J5  
Beckton Tamara W550 A

**Beckton Julian F067 L7**

Ref. J-4 < Beckton Indigo D786 L < Beckton Likable Z057 L4  
Beckton Indigo Y026 N

Beckton Warrior Y108 E5 < Beckton Warrior W534 N4  
Beckton Susan W058 E

**Beckton Lana C819 W**

Beckton Lana U789 NB < Beckton Nebula M045  
Beckton Lana P073 EP

BWt **63**

WR **109**

YWt. **1034**

YR **104**

FebADG **3.34**

Frame **5.0**

Feet **Good**

DAM		Calv.Ease	BW	WW	YW	Milk	HPG	Stay	Maint.En.	
Age	7	EPDs	20	-5.8	54	103	29	13	13	10.0
Wt	1240	Marb	+0.48		REA	-0.06		Bfat	+0.05	
Prog. BW	66	Beef Tenderness →	DNA: 10 / Outstanding		Scan:	1.7 / Tender				
WR	105	HerdBuilder Index:	30	Pct.: 91%	ProS:	85	Pct.: 62%			
YR	100	★★★★★ for Marbling, Calving Ease.								
Udder	Very Good									
Wean Pct.	43%									
Cow Eff.	90									



Lot 160

\*Note: Scrotal and ultrasound data will be available later

## 163 Beckton Warrior K784 A8

1-A 100% # 4675229 Tat: BKT2 K784



Birth: 4-25-22

Beckton Warrior D359 L6 < Beckton Warrior Y108 E5  
Beckton Lana W463 L

**Beckton Warrior G356 N7**

Ref. W-1 < Beckton Larkaba B277 N < Beckton New Era Y194  
Beckton Larkaba U062 CB

Beckton Accent U777 C2 < Beckton Cody K1 P014  
Beckton Susan R022 CQ

**Beckton Pine Marie A513 A**

BKT Pine Marie X424 H < Beckton Hasten U108 J3  
BKT Pine Marie U481 NM

BWt	78
WR	108
YWt.	999
YR	100
FebADG	3.31
Frame	5.0
Feet	Good

DAM	
Age	9
Wt	995
Prog. BW	71
WR	100
YR	100
Udder	Very Good
Wean Pct.	53%
Cow Eff.	111

Calv.Ease	BW	WW	YW	Milk	HPG	Stay	Maint.En.
EPDs	15	-2.7	59	96	28	13	-2.0
Marb	+.27		REA -.06		Bfat +.03		
Beef Tenderness	→ DNA: 10 / Outstanding		Scan: 1.7 / Tender				
HerdBuilder Index:	63	Pct.: 35%	ProS: 83		Pct.: 65%		

★★★★★ for Low Maintenance, Marbling, Calving Ease.

## 166 Beckton Nebula K775 E5

1-A 100% # 4676379 Tat: BSF2 K775



Birth: 4-24-22

Beckton Nebula T398 V3 < Beckton Nebula L P093  
Beckton Minerva J615 VG

**Beckton Nebula A773 L4**

Ref. N-2 < Beckton Mona X022 L < Beckton Likable U130 L2  
Beckton Mona U584 CD

Beckton Emcee W526 J2 < Beckton Emcee S466  
Beckton Larkaba P645 JL

**Beckton Larkaba Z603 E**

Beckton Julian G3 P608  
Beckton Larkaba N708 HR

BWt	77
WR	116
YWt.	1054
YR	105
FebADG	3.68
Frame	5.5
Feet	Good

DAM	
Age	10
Wt	1180
Prog. BW	68
WR	105
YR	102
Udder	Very Good
Wean Pct.	46%
Cow Eff.	97

Calv.Ease	BW	WW	YW	Milk	HPG	Stay	Maint.En.
EPDs	14	-3.4	61	90	30	12	-1.0
Marb	+.36		REA -.11		Bfat +.03		
Beef Tenderness	→ DNA: 10 / Outstanding		Scan: 2.3 / Tender				
HerdBuilder Index:	82	Pct.: 8%	ProS: 105		Pct.: 30%		

★★★★★ for Low Maintenance, Gainability, Marbling, Calving Ease.

## 164 Beckton Oracle K170 A2

1-A 100% # 4675149 Tat: BKT2 K170



Birth: 3-8-22

Schuler Sudden Impact 0004X < Red Crowfoot Ole's Oscar  
SOR Duchess TS 8915U

**Schuler Oracle-7142E**

Ref. O-2 < Sor Marlee Cmmtmnt 0470X < Brown Commitment S7206  
SOR Marlee Beef 4511P

Beckton Accent U777 C2 < Beckton Cody K1 P014  
Beckton Susan R022 CQ

**Beckton Larkaba Y454 A**

Beckton Larkaba U498 EP < Beckton Epic R350 K  
Beckton Larkaba R336 CK

BWt	62
WR	89
YWt.	932
YR	94
FebADG	2.59
Frame	5.0
Feet	Good

DAM	
Age	11
Wt	1085
Prog. BW	73
WR	103
YR	106
Udder	Very Good
Wean Pct.	38%
Cow Eff.	80

Calv.Ease	BW	WW	YW	Milk	HPG	Stay	Maint.En.
EPDs	17	-3.9	53	95	26	12	1.0
Marb	+.63		REA +.05		Bfat +.02		
Beef Tenderness	→ DNA: 10 / Outstanding		Scan: 1.5 / Tender +				
HerdBuilder Index:	71	Pct.: 21%	ProS: 134		Pct.: 5%		

★★★★★ for Marbling, Calving Ease.

## 167 BKT Maximus K506

1-A 100% # 4675903 Tat: BKT2 K506



Birth: 4-1-22

Red Angus multiple sire < Red Angus multiple sire  
Red Angus dam

**Red Angus multiple sire**

Ref. NA < Red Angus dam < Red Angus multiple sire  
Red Angus dam

Beckton Ranger B006 D5 < Beckton Ranger Z225 J4  
Beckton Suffeina Z731 D

**Beckton Lana G792 R**

Beckton Lana D023 N < Beckton New Era B265 J2  
Beckton Lana B485 L

BWt	67
WR	116
YWt.	991
YR	101
FebADG	3.02
Frame	5.5
Feet	Good

DAM	
Age	3
Wt	955
Prog. BW	67
WR	116
YR	101
Udder	Very Good
Wean Pct.	53%
Cow Eff.	111

Calv.Ease	BW	WW	YW	Milk	HPG	Stay	Maint.En.
EPDs	15	-2.0	53	77	25	NA	7 NA
Marb	+.64		REA +.20		Bfat +.04		
Beef Tenderness	→ DNA: 7 / Very Good		Scan: 1.7 / Tender				
HerdBuilder Index:	12	Pct.: 99%	ProS: 81		Pct.: 68%		

★★★★★ for Marbling, Rib-eye area, Calving Ease.

## 165 Beckton Dominor K029 A8

1-A 100% # 4676189 Tat: BKT2 K029



Birth: 2-17-22

Beckton Dominor Y052 N6 < Beckton Dominor W640 C5  
Beckton Indigo W772 N

**Beckton Dominor H382 N7**

Ref. D-3 < Beckton Coca E847 N < Beckton Nebula Z111 N5  
Beckton Coca A271 N

Beckton Accent E172 L3 < Beckton Accent W180 C2  
Beckton Indigo Y406 L

**Beckton Lydia H230 A**

Beckton Lydia S069 NB < Beckton Nebula P P707  
Beckton Lydia P583 WR

BWt	55
WR	100
YWt.	934
YR	100
FebADG	3.43
Frame	5.5
Feet	Good

DAM	
Age	2
Wt	925
Prog. BW	55
WR	100
YR	100
Udder	Very Good
Wean Pct.	46%
Cow Eff.	97

Calv.Ease	BW	WW	YW	Milk	HPG	Stay	Maint.En.
EPDs	14	-4.1	62	105	27	14	5.0
Marb	+.33		REA +.07		Bfat +.03		
Beef Tenderness	→ DNA: 9 / Outstanding		Scan: 2.0 / Tender				
HerdBuilder Index:	57	Pct.: 46%	ProS: 94		Pct.: 48%		

★★★★★ for Marbling, Calving Ease.



Lot 167

\*Note: Scrotal and ultrasound data will be available later



Lot 168

## 170 Beckton Heritage K055 H6

1-A 100% # 4676247 Tat: BKT2 K055



BWt	62
WR	113
YWt	984
YR	102
FebADG	2.60
Frame	5.5
Feet	Good

Birth: 2-19-22

Beckton Heritage C477 J4 < Beckton Heritage X403 L3  
 Beckton Ruth Z858 J

**Beckton Heritage H181 N5**  
 Ref. H-2 < Beckton Sierra Y441 N < Beckton Nebula T269 E2  
 Beckton Sierra S120 HW

Beckton Heritage F615 L5 < Beckton Heritage B612 J4  
 Beckton Mona X022 L

**Beckton Christy H096 H**  
 Beckton Christy F009 E < Beckton Epic D002 E8  
 Beckton Christy D394 N

DAM		Calv.Ease	BW	WW	YW	Milk	HPG	Stay	Maint.En.
Age	2	EPDs	13	-3.0	62	97	33	NA	17
Wt	850	Marb	+0.33		REA	+0.08		Bfat	+0.04
Prog. BW	62	Beef Tenderness	→ DNA: 7 / Very Good		Scan:	1.4 / Tender +			
WR	113	HerdBuilder Index:	66	Pct.: 29%	ProS:	86	Pct.: 61%		
YR	102	★★★★★ for Low Maintenance, Marbling, Calving Ease.							
Udder	Good								
Wean Pct.	49%								
Cow Eff.	103								

## 168 Beckton Oracle K099 A3

1-A 100% # 4676217 Tat: BKT2 K099



BWt	65
WR	110
YWt	992
YR	101
FebADG	3.21
Frame	5.5
Feet	Good

Birth: 2-27-22

Schuler Oracle-7142E < Schuler Sudden Impact 0004X  
 Sor Marlee Cmmmtnt 0470X

**Beckton Oracle H725 S2**  
 Ref. 0 < Beckton Scamp C349 C4  
 Beckton Ruth E092 S < Beckton Ruth C611 S

Beckton Accent E172 L3 < Beckton Accent W180 C2  
 Beckton Indigo Y406 L

**Beckton Pine Marie H169 A**  
 Beckton Pine Marie E424 C < Beckton Cardinal B074 N  
 Beckton Pine Marie A074 C

DAM		Calv.Ease	BW	WW	YW	Milk	HPG	Stay	Maint.En.
Age	2	EPDs	15	-2.7	57	95	27	NA	16
Wt	755	Marb	+0.44		REA	+0.15		Bfat	+0.02
Prog. BW	65	Beef Tenderness	→ DNA: 10 / Outstanding		Scan:	1.6 / Tender +			
WR	110	HerdBuilder Index:	64	Pct.: 32%	ProS:	102	Pct.: 34%		
YR	101	★★★★★ for Marbling, Rib-eye area, Cow Efficiency, Calving Ease.							
Udder	Very Good								
Wean Pct.	58%								
Cow Eff.	121								

## 171 Beckton Dominor K550 L9

1-A 100% # 4676323 Tat: BSF2 K550



BWt	57
WR	106
YWt	1007
YR	101
FebADG	2.44
Frame	5.0
Feet	Good

Birth: 4-3-22

Beckton Dominor A378 W7 < Beckton Dominor Y005 V6  
 Beckton Lana Y541 W

**Beckton Dominor F263 N8**  
 Ref. D-1 < Beckton Nebula EN S347  
 Beckton Larkaba W272 N < Beckton Larkaba N643 HR

Beckton Legend S670 < Beckton Lancer F442 T  
 Beckton Kit F468 JL

**Beckton Encino X448 L**  
 Beckton Encino S059 JT < Beckton Jet L P491  
 Beckton Encino P871 HR

DAM		Calv.Ease	BW	WW	YW	Milk	HPG	Stay	Maint.En.
Age	12	EPDs	21	-5.4	47	66	31	14	17
Wt	1150	Marb	+0.46		REA	+0.03		Bfat	+0.03
Prog. BW	57	Beef Tenderness	→ DNA: NA / NA		Scan:	1.5 / Tender +			
WR	96	HerdBuilder Index:	86	Pct.: 6%	ProS:	108	Pct.: 26%		
YR	95	★★★★★ for Low Maintenance, Marbling, Calving Ease.							
Udder	Very Good								
Wean Pct.	43%								
Cow Eff.	90								

## 169 Beckton Jet K358 N3

1-A 100% # 4676329 Tat: BSF2 K358



BWt	61
WR	105
YWt	964
YR	97
FebADG	2.95
Frame	5.5
Feet	Good

Birth: 3-24-22

Beckton Jet L P491 < TR Julian Lt151  
 Beckton Minerva L278 LN

**Beckton Jet G441 N2**  
 Ref. J-5 < Beckton New Era Y194  
 Beckton Susan B246 N < Beckton Susan R022 CQ

Beckton Nebula T398 V3 < Beckton Nebula L P093  
 Beckton Minerva J615 VG

**Beckton Barmaid X654 N**  
 Beckton Barmaid S758 DM < Beckton Dominor ZC M919  
 Beckton Barmaid K080 CH

DAM		Calv.Ease	BW	WW	YW	Milk	HPG	Stay	Maint.En.
Age	12	EPDs	18	-6.9	49	73	31	11	20
Wt	1190	Marb	+0.45		REA	-0.14		Bfat	+0.03
Prog. BW	68	Beef Tenderness	→ DNA: 10 / Outstanding		Scan:	1.5 / Tender +			
WR	100	HerdBuilder Index:	85	Pct.: 6%	ProS:	112	Pct.: 21%		
YR	101	★★★★★ for Low Maintenance, Marbling, Calving Ease.							
Udder	Very Good								
Wean Pct.	41%								
Cow Eff.	86								



Lot 171

\*Note: Scrotal and ultrasound data will be available later



## 172 Beckton Accent K670 E4

1-A 100% # 4675867 Tat: BKT2 K670



Birth: 4-13-22  
 Beckton Accent W180 C2 < Beckton Cody K1 P014  
 Beckton Christy R046 CQ  
**Beckton Accent F602 L3**  
 Ref. A-4 < Beckton Lana B670 L  
 Beckton Likable U130 L2  
 Beckton Lana Y541 W  
 Beckton Epic D275 L7 < Beckton Epic Z674 E6  
 Beckton Lana X839 L  
**Beckton Rose G317 E**  
 Beckton Rose C681 A < Beckton Accent Y260 L3  
 Beckton Rose W283 J

BWt	66
WR	119
YWt.	1049
YR	107
FebADG	3.37
Frame	5.5
Feet	Good

DAM		Calv.Ease	BW	WW	YW	Milk	HPG	Stay	Maint.En.	
Age	3	EPDs	16	-2.9	68	108	28	12	18	1.0
Wt	915	Marb	+0.37		REA	+0.17		Bfat	+0.03	
Prog. BW	61	Beef Tenderness →	DNA: 10 / Outstanding		Scan:	2.0 / Tender				
WR	114	HerdBuilder Index:	81	Pct.: 9%	ProS:	104	Pct.: 32%			
YR	106	★★★★★ for Growth, Marbling, Rib-eye area, Superior Cow, Cow Efficiency, Calving Ease.								
Udder	Very Good									
Wean Pct.	57%									
Cow Eff.	119									

## 175 Beckton Dominor K564 L9

1-A 100% # 4675647 Tat: BKT2 K564



Birth: 4-4-22  
 Beckton Dominor A378 W7 < Beckton Dominor Y005 V6  
 Beckton Lana Y541 W  
**Beckton Dominor F263 N8**  
 Ref. D-1 < Beckton Larkaba W272 N  
 Beckton Nebula EN S347  
 Beckton Larkaba N643 HR  
 Beckton Likable C643 L3 < Beckton Likable U130 L2  
 Beckton Minola X107 L  
**Beckton Kit F666 L**  
 Beckton Kit A595 N < Beckton Nebula P P707  
 Beckton Kit X237 L

BWt	76
WR	108
YWt.	997
YR	99
FebADG	3.52
Frame	5.5
Feet	Good

DAM		Calv.Ease	BW	WW	YW	Milk	HPG	Stay	Maint.En.	
Age	4	EPDs	17	-3.1	52	82	34	14	17	-2.0
Wt	925	Marb	+0.55		REA	+0.08		Bfat	+0.04	
Prog. BW	62	Beef Tenderness →	DNA: 10 / Outstanding		Scan:	1.3 / Tender +				
WR	104	HerdBuilder Index:	78	Pct.: 12%	ProS:	118	Pct.: 14%			
YR	98	★★★★★ for Low Maintenance, Gainability, Marbling, Calving Ease.								
Udder	Very Good									
Wean Pct.	53%									
Cow Eff.	111									

## 173 Beckton Likable K684 A7

1-A 100% # 4675807 Tat: BKT2 K684



Birth: 4-15-22  
 Beckton Likable B032 C5 < Beckton Likable Z057 L4  
 Beckton Mona Z270 C  
**Beckton Likable F287 J6**  
 Ref. L-4 < Beckton Julian U699 L5  
 Beckton Larkaba X064 J < Beckton Larkaba U475 CT  
 Beckton Accent B653 C3 < Beckton Accent U777 C2  
 Beckton Christy W779 C  
**Beckton Coca G362 A**  
 Beckton Coca Z529 A < Beckton Accent W180 C2  
 Beckton Coca T168 NB

BWt	64
WR	128
YWt.	992
YR	101
FebADG	2.57
Frame	5.5
Feet	Good

DAM		Calv.Ease	BW	WW	YW	Milk	HPG	Stay	Maint.En.	
Age	3	EPDs	18	-5.0	62	98	29	15	19	3.0
Wt	815	Marb	+0.38		REA	-0.10		Bfat	+0.05	
Prog. BW	54	Beef Tenderness →	DNA: 9 / Outstanding		Scan:	1.5 / Tender +				
WR	120	HerdBuilder Index:	86	Pct.: 5%	ProS:	90	Pct.: 54%			
YR	104	★★★★★ for Marbling, Superior Cow, Cow Efficiency, Calving Ease.								
Udder	Very Good									
Wean Pct.	69%									
Cow Eff.	145									

## 176 Beckton Ranger K163 N7

1-A 100% # 4675415 Tat: BKT2 K163



Birth: 3-7-22  
 Beckton Ranger B006 D5 < Beckton Ranger Z225 J4  
 Beckton Suffeina Z731 D  
**Beckton Ranger G299 N6**  
 Ref. R-1 < Beckton Indigo C018 N  
 Beckton Nebula A773 L4  
 Beckton Indigo A849 N  
 Beckton New Era B265 J2 < Beckton New Era Y194  
 Beckton Minerva W901 J  
**Beckton Coca D081 N**  
 Beckton Coca B550 W < Beckton Warrior W534 N4  
 Beckton Coca T419 NB

BWt	64
WR	98
YWt.	860
YR	86
FebADG	2.54
Frame	5.0
Feet	Good

DAM		Calv.Ease	BW	WW	YW	Milk	HPG	Stay	Maint.En.	
Age	6	EPDs	18	-6.0	47	74	30	12	16	-2.0
Wt	1015	Marb	+0.45		REA	-0.19		Bfat	+0.03	
Prog. BW	60	Beef Tenderness →	DNA: 10 / Outstanding		Scan:	1.8 / Tender				
WR	106	HerdBuilder Index:	57	Pct.: 47%	ProS:	79	Pct.: 71%			
YR	100	★★★★★ for Low Maintenance, Marbling, Calving Ease.								
Udder	Very Good									
Wean Pct.	47%									
Cow Eff.	99									

## 174 Beckton Lancer K445 C2

1-A 100% # 4675107 Tat: BKT2 K445



Birth: 3-29-22  
 Redhill U199 Lancer 9B < Buf Crk The Right Kind U199  
 Buf Crk Redpride P154  
**Redhill 9B Lancer 11E**  
 Ref. O-1 < Redhill T189 Barmaid 190W  
 Buf Crk Nice'N Easy T189  
 1BWJ Barmaid 54P  
 Beckton Cody K1 P014 < Beckton Cody KH M390  
 Beckton Rose M126 WR  
**Beckton Tamara W550 A**  
 Beckton Tamara R175 CQ < Beckton Cherokee N N479  
 Beckton Tamara N765 CO

BWt	89
WR	107
YWt.	997
YR	100
FebADG	3.46
Frame	5.0
Feet	Good

DAM		Calv.Ease	BW	WW	YW	Milk	HPG	Stay	Maint.En.	
Age	13	EPDs	10	-0.8	62	94	30	15	16	5.0
Wt	1180	Marb	+0.39		REA	-0.22		Bfat	+0.05	
Prog. BW	72	Beef Tenderness →	DNA: 9 / Outstanding		Scan:	1.6 / Tender +				
WR	111	HerdBuilder Index:	50	Pct.: 61%	ProS:	64	Pct.: 90%			
YR	108	★★★★★ for Marbling, Superior Cow.								
Udder	Good									
Wean Pct.	42%									
Cow Eff.	89									



Not for sale

\*Note: Scrotal and ultrasound data will be available later

**177****Beckton Warrior K317 N8**

1-A 100% # 4675129 Tat: BKT2 K317



Birth: 3-21-22

Beckton Warrior D359 L6	Beckton Warrior Y108 E5	BWt	72
Beckton Lana W463 L	Beckton Lana W463 L	WR	103
<b>Beckton Warrior G356 N7</b>	Beckton New Era Y194	YWt.	915
Ref. W-1	Beckton Larkaba U062 CB	YR	92
Beckton Larkaba B277 N	Beckton Nebula P P707	FebADG	2.76
Beckton Nebula PJ S543	Beckton Lana P685 JO	Frame	5.0
<b>Beckton Coca X675 N</b>	Beckton Julian G2 M345	Feet	Good
Beckton Coca T363 JL	Beckton Coca P435 CH		

<b>DAM</b>	Calv.Ease	BW	WW	YW	Milk	HPG	Stay	Maint.En.
Age	12							
Wt	1080	EPDs	16	-4.6	51	80	27	13
Prog. BW	59	Marb	+0.36	REA	-0.12	Bfat	+0.03	
WR	99	Beef Tenderness →	DNA: 9 / Outstanding	Scan:	1.5 / Tender +			
YR	99	HerdBuilder Index:	50	Pct.:	60%	ProS:	68	Pct.:
Udder	Very Good							85%
Wean Pct.	45%	★★★★★ for Low Maintenance, Marbling, Calving Ease.						
Cow Eff.	94							



Lot 177

**178****Beckton Hughes K441 J4**

1-A 100% # 4675311 Tat: BKT2 K441



Birth: 3-29-22

Beckton Hughes D589 S2	Bieber H Hughes W109	BWt	67
Beckton Sierra Z353 S	Beckton Sierra Z353 S	WR	103
<b>Beckton Hughes F076 H3</b>	Bieber H Hughes W109	YWt.	937
Ref. B-1	Beckton Emera A186 A	YR	94
Beckton Emera D487 B	TR Julian Lt151	FebADG	2.38
Beckton Jet L P491	Beckton Minerva L278 LN	Frame	5.0
<b>Beckton Rose C777 J</b>	Beckton Nebula P P707	Feet	Good
Beckton Rose Z247 N	Beckton Rose R507 CT		

<b>DAM</b>	Calv.Ease	BW	WW	YW	Milk	HPG	Stay	Maint.En.
Age	7	EPDs	18	-4.9	52	80	27	12
Wt	1110	Marb	+0.43	REA	-0.12	Bfat	+0.03	
Prog. BW	63	Beef Tenderness →	DNA: 9 / Outstanding	Scan:	1.7 / Tender			
WR	99	HerdBuilder Index:	78	Pct.:	12%	ProS:	99	Pct.:
YR	98							38%
Udder	Good	★★★★★ for Low Maintenance, Marbling, Calving Ease.						
Wean Pct.	45%							
Cow Eff.	95							

**179****BSF Oracle K406 O3**

1-B 99% # 4676935 Tat: BSF2 K406



Birth: 3-27-22

Schuler Oracle-7142E	Schuler Sudden Impact 0004X	BWt	54
Sor Marlee Cmmtmnt 0470X	Sor Marlee Cmmtmnt 0470X	WR	106
<b>Beckton Oracle H390 L2</b>	Beckton Legend S670	YWt.	1055
Ref. O-5	Beckton Lana T348 NB	YR	107
Beckton Lana D222 L	Schuler Sudden Impact 0004X	FebADG	3.46
Schuler Oracle-7142E	Sor Marlee Cmmtmnt 0470X	Frame	5.0
<b>BSF Codette H426 O</b>	Beckton Nebula X353 E3	Feet	Good
BSF Codette Z044 N	BSF Codette X384 E		

<b>DAM</b>	Calv.Ease	BW	WW	YW	Milk	HPG	Stay	Maint.En.
Age	2	EPDs	18	-4.3	65	117	27	NA
Wt	925	Marb	+0.57	REA	+0.21	Bfat	+0.03	
Prog. BW	54	Beef Tenderness →	DNA: 9 / Outstanding	Scan:	1.7 / Tender			
WR	106	HerdBuilder Index:	66	Pct.:	29%	ProS:	137	Pct.:
YR	107							4%
Udder	Very Good	★★★★★ for Growth, Marbling, Rib-eye area, Superior Cow, Calving Ease.						
Wean Pct.	45%							
Cow Eff.	95							

**180****Beckton Oracle K283 E**

1-A 100% # 4676357 Tat: BSF2 K283



Birth: 3-19-22

Schuler Sudden Impact 0004X	Red Crowfoot Ole's Oscar	BWt	71
SOR Duchess TS 8915U	SOR Duchess TS 8915U	WR	81
<b>Schuler Oracle-7142E</b>	Brown Commitment S7206	YWt.	984
Ref. O-2	SOR Marlee Beef 4511P	YR	99
Sor Marlee Cmmtmnt 0470X	Beckton Epic K4 N795	FebADG	4.48
Beckton Epic U749 D5	Beckton Denise R308 DM	Frame	4.5
<b>Beckton Christy Z958 E</b>	Beckton Cody K1 P014	Feet	Good
Beckton Christy W831 A	Beckton Christy M362 WR		

<b>DAM</b>	Calv.Ease	BW	WW	YW	Milk	HPG	Stay	Maint.En.
Age	10	EPDs	18	-4.1	48	92	25	9
Wt	1270	Marb	+0.65	REA	+0.17	Bfat	+0.03	
Prog. BW	64	Beef Tenderness →	DNA: 10 / Outstanding	Scan:	1.8 / Tender			
WR	103	HerdBuilder Index:	35	Pct.:	85%	ProS:	109	Pct.:
YR	104							24%
Udder	Very Good	★★★★★ for Gainability, Marbling, Rib-eye area, Superior Cow, Calving Ease.						
Wean Pct.	31%							
Cow Eff.	66							

**181****BSF Likable K786 C4**

1-B 99% # 4676599 Tat: BSF2 K786



Birth: 4-25-22

Beckton Likable U130 L2	Beckton Likable S633	BWt	84
Beckton Kit S478 LN	Beckton Kit S478 LN	WR	104
<b>Beckton Likable E636 C3</b>	BKT Clifftop TP R288	YWt.	995
Ref. L-3	Beckton Minola R604 CD	YR	99
Beckton Minola W808 C	TR Double Eagle ZT220	FebADG	3.24
Beckton Cardinal B074 N	BKT Pine Marie Z250 N	Frame	4.5
<b>BSF Clifftana E375 C</b>	Beckton Legend S670	Feet	Good
BSF Clifftana A563 L	BSF Clifftana U655 CT		

<b>DAM</b>	Calv.Ease	BW	WW	YW	Milk	HPG	Stay	Maint.En.
Age	5	EPDs	15	-3.2	55	83	28	13
Wt	1095	Marb	+0.24	REA	+0.31	Bfat	+0.02	
Prog. BW	84	Beef Tenderness →	DNA: 7 / Very Good	Scan:	1.7 / Tender			
WR	106	HerdBuilder Index:	74	Pct.:	16%	ProS:	78	Pct.:
YR	107							73%
Udder	Very Good	★★★★★ for Low Maintenance, Marbling, Rib-eye area, Superior Cow, Calving Ease.						
Wean Pct.	44%							
Cow Eff.	93							

\*Note: Scrotal and ultrasound data will be available later

## 182 Beckton Accent K866 E4

1-A 100% # 4675677 Tat: BKT2 K866

Birth: 5-7-22

Beckton Accent B740 W3  
Ref. A-3

Beckton Lana F434 E

Beckton Cody K1 P014  
Beckton Christy R046 CQ  
Beckton Warrior W534 N4  
Beckton Lana W370 E  
Beckton Epic U749 D5  
BKT Pine Marie X339 N  
Beckton Accent W180 C2  
Beckton Lana T646 EP

BWt	70
WR	101
YWt.	1074
YR	108
FebADG	3.61
Frame	5.0
Feet	Good

DAM	
Age	4
Wt	875
Prog. BW	57
WR	107
YR	107
Udder	Very Good
Wean Pct.	54%
Cow Eff.	114

Calv.Ease	BW	WW	YW	Milk	HPG	Stay	Maint.En.	
EPDs	16	-4.7	59	100	29	11	14	6.0
Marb	+0.45		REA +0.29		Bfat +0.05			
Beef Tenderness →	DNA: 9 / Outstanding		Scan: 1.3 / Tender +					
HerdBuilder Index:	43	Pct.: 74%	ProS: 76		Pct.: 77%			

★★★★★ for Growth, Gainability, Marbling, Rib-eye area, Superior Cow, Calving Ease.



Lot 182

## 183 Beckton Nebula K681 E4

1-A 100% # 4675537 Tat: BKT2 K681

Birth: 4-14-22

Beckton Nebula G249 N4  
Ref. N-4

Beckton Ruth E761 E

Beckton Nebula P P707  
Beckton Larkaba T813 JC  
Beckton Nebula W022 D3  
Beckton Lana W525 D  
Beckton Epic U749 D5  
BKT Pine Marie X339 N  
Beckton Julian U699 L5  
Beckton Ruth U557 JT

BWt	60
WR	88
YWt.	973
YR	98
FebADG	3.46
Frame	4.5
Feet	Good

DAM	
Age	5
Wt	985
Prog. BW	59
WR	95
YR	96
Udder	Very Good
Wean Pct.	44%
Cow Eff.	92

Calv.Ease	BW	WW	YW	Milk	HPG	Stay	Maint.En.	
EPDs	17	-6.1	43	83	30	12	19	3.0
Marb	+0.55		REA -.09		Bfat +0.04			
Beef Tenderness →	DNA: 9 / Outstanding		Scan: 1.9 / Tender					
HerdBuilder Index:	70	Pct.: 22%	ProS: 136		Pct.: 4%			

★★★★★ for Marbling, Calving Ease.

## 185 Beckton Scamp K113 H7

1-A 100% # 4677025 Tat: BSF2 K113

Birth: 3-2-22

Beckton Scamp H076 E6  
Ref. S-4

Beckton Angel H029 H

Beckton Scamp B720 L4  
Beckton Angel X450 N  
Beckton Epic B310 J6  
Beckton Larkaba B409 L  
Beckton Heritage B612 J4  
Beckton Mona X022 L  
Beckton Epic D457 C7  
Beckton Angel D214 W

BWt	45
WR	99
YWt.	1012
YR	105
FebADG	3.56
Frame	4.5
Feet	Good

DAM	
Age	2
Wt	750
Prog. BW	45
WR	99
YR	105
Udder	Very Good
Wean Pct.	48%
Cow Eff.	100

Calv.Ease	BW	WW	YW	Milk	HPG	Stay	Maint.En.	
EPDs	19	-5.9	57	88	30	NA	15	1.0
Marb	+0.34		REA -.03		Bfat +0.03			
Beef Tenderness →	DNA: 9 / Outstanding		Scan: 1.9 / Tender					
HerdBuilder Index:	59	Pct.: 42%	ProS: 80		Pct.: 70%			

★★★★★ for Gainability, Marbling, Calving Ease.

## 184 Beckton Julian K116 H9

1-A 100% # 4676877 Tat: BSF2 K116

Birth: 3-2-22

Beckton Julian H023 E8  
Ref. J-6

Beckton Indigo H703 H

Beckton Julian D551 C6  
Beckton Indigo D786 L  
Beckton Epic B310 J6  
Beckton Encino B056 R  
Beckton Heritage X403 L3  
Beckton Ruth Z858 J  
Beckton Ranger B006 D5  
Beckton Indigo B054 W

BWt	54
WR	96
YWt.	1004
YR	102
FebADG	3.52
Frame	4.5
Feet	Good

DAM	
Age	2
Wt	725
Prog. BW	54
WR	96
YR	102
Udder	Very Good
Wean Pct.	51%
Cow Eff.	108

Calv.Ease	BW	WW	YW	Milk	HPG	Stay	Maint.En.	
EPDs	19	-4.9	56	104	28	NA	13	2.0
Marb	+0.32		REA +0.08		Bfat +0.03			
Beef Tenderness →	DNA: 10 / Outstanding		Scan: 1.6 / Tender +					
HerdBuilder Index:	42	Pct.: 75%	ProS: 97		Pct.: 43%			

★★★★★ for Gainability, Marbling, Calving Ease.

## 186 Beckton Epic K287 L9

1-A 100% # 4676285 Tat: BKT2 K287

Birth: 3-19-22

Beckton Epic H312 A8  
Ref. E-2

Beckton Lana H015 L

Beckton Epic D001 L7  
Beckton Epic B483 N6  
Beckton Mona B713 L  
Beckton Accent Y260 L3  
Beckton Larkaba Y156 N  
Beckton Likable Z057 L4  
Beckton Sierra A836 N  
Beckton Nebula B557 J3  
Beckton Lana W696 N

BWt	64
WR	103
YWt.	1014
YR	103
FebADG	4.17
Frame	5.0
Feet	Good

DAM	
Age	2
Wt	840
Prog. BW	64
WR	103
YR	103
Udder	Very Good
Wean Pct.	48%
Cow Eff.	101

Calv.Ease	BW	WW	YW	Milk	HPG	Stay	Maint.En.	
EPDs	12	-2.4	62	102	27	NA	19	8.0
Marb	+0.41		REA +0.11		Bfat +0.03			
Beef Tenderness →	DNA: 10 / Outstanding		Scan: 1.4 / Tender +					
HerdBuilder Index:	62	Pct.: 36%	ProS: 93		Pct.: 49%			

★★★★★ for Gainability, Marbling, Calving Ease.

\*Note: Scrotal and ultrasound data will be available later

## 187 Beckton Accent K525 L5

1-A 100% # 4675947 Tat: BKT2 K525

Birth: 4-2-22

Beckton Accent E172 L3 < Beckton Accent W180 C2  
Beckton Indigo Y406 L

**Beckton Accent G107 C4**

Ref. A-5 < Beckton Pine Marie E206 D < TR Double Eagle ZT220  
BKT Pine Marie W404 J

Beckton Legend E464 L4 < Beckton Legend Z689 J3  
Beckton Ucola X143 L

**Beckton Mona G063 L**

Beckton Mona E460 H < Beckton Hasten Y069 D4  
Beckton Mona A671 J

BWt	56
WR	92
YWt.	1006
YR	103
FebADG	3.52
Frame	5.0
Feet	Good

DAM	Calv.Ease	BW	WW	YW	Milk	HPG	Stay	Maint.En.
Age	3							
Wt	850	EPDs	18	-5.9	54	93	29	NA
Prog. BW	56	Marb	+0.45		REA	+0.13		Bfat
WR	98	Beef Tenderness	→ DNA: 9 / Outstanding		Scan:	1.6 / Tender +		
YR	99	HerdBuilder Index:	54	Pct.: 52%	ProS:	106	Pct.: 29%	
Udder	Very Good	★★★★★ for Gainability, Marbling, Rib-eye area, Calving Ease.						
Wean Pct.	46%							
Cow Eff.	97							

## 189 Beckton Nebula K823 A5

1-A 100% # 4675405 Tat: BKT2 K823

Birth: 4-30-22

Beckton Nebula B557 J3 < Beckton Nebula P P707  
Beckton Larkaba T813 JC

**Beckton Nebula F440 H4**

Ref. N-3 < Beckton Hasten H S462  
Beckton Minola N751 JL

Beckton Accent B653 C3 < Beckton Accent U777 C2  
Beckton Christy W779 C

**Beckton Susan D040 A**

Beckton Susan B246 N < Beckton New Era Y194  
Beckton Susan R022 CQ

BWt	59
WR	100
YWt.	1010
YR	100
FebADG	3.42
Frame	5.0
Feet	Good

DAM	Calv.Ease	BW	WW	YW	Milk	HPG	Stay	Maint.En.
Age	6							
Wt	855	EPDs	17	-5.4	53	82	29	13
Prog. BW	66	Marb	+0.52		REA	-0.14		Bfat
WR	106	Beef Tenderness	→ DNA: 10 / Outstanding		Scan:	2.0 / Tender		
YR	98	HerdBuilder Index:	70	Pct.: 23%	ProS:	103	Pct.: 33%	
Udder	Very Good	★★★★★ for Low Maintenance, Marbling, Calving Ease.						
Wean Pct.	55%							
Cow Eff.	115							



Lot 187

## 190 Beckton Cardinal K610 E2

1-A 100% # 4675751 Tat: BKT2 K610

Birth: 4-8-22

TR Double Eagle ZT220 < TR Ricardo DOS  
Beckton Lana U182 JC

**Beckton Cardinal E673 L**

Ref. C-1 < Beckton Legend U331 E2  
Beckton Larkaba A911 L < Beckton Larkaba T418 WA

Beckton Epic D002 E8 < Beckton Epic B545 N7  
Beckton Christy B701 E

**Beckton Tamara F107 E**

Beckton Tamara D428 N < Beckton Nebula W486 D3  
Beckton Tamara X628 E

BWt	59
WR	97
YWt.	977
YR	98
FebADG	2.89
Frame	5.0
Feet	Good

DAM	Calv.Ease	BW	WW	YW	Milk	HPG	Stay	Maint.En.
Age	4							
Wt	925	EPDs	21	-6.5	56	91	28	12
Prog. BW	60	Marb	+0.55		REA	+0.16		Bfat
WR	97	Beef Tenderness	→ DNA: 7 / Very Good		Scan:	1.5 / Tender +		
YR	99	HerdBuilder Index:	88	Pct.: 4%	ProS:	140	Pct.: 3%	
Udder	Very Good	★★★★★ for Marbling, Rib-eye area, Calving Ease.						
Wean Pct.	49%							
Cow Eff.	103							

## 188 Beckton Julian K073 L9

1-A 100% # 4675999 Tat: BKT2 K073

Birth: 2-22-22

Beckton Julian F067 L7 < Beckton Julian D551 C6  
Beckton Indigo D786 L

**Beckton Julian H023 E8**

Ref. J-6 < Beckton Epic B310 J6  
Beckton Encino B056 R

Beckton Likable U130 L2 < Beckton Likable D432 N3  
Beckton Firefly W013 N

**Beckton Lana H812 C**

Beckton Lana D020 N < Beckton Nebula B620 E5  
Beckton Lana B832 N

BWt	54
WR	88
YWt.	968
YR	98
FebADG	3.87
Frame	5.0
Feet	Good

DAM	Calv.Ease	BW	WW	YW	Milk	HPG	Stay	Maint.En.
Age	2							
Wt	735	EPDs	17	-3.6	53	98	25	NA
Prog. BW	54	Marb	+0.36		REA	-0.05		Bfat
WR	88	Beef Tenderness	→ DNA: 9 / Outstanding		Scan:	1.8 / Tender		
YR	98	HerdBuilder Index:	43	Pct.: 74%	ProS:	93	Pct.: 48%	
Udder	Very Good	★★★★★ for Low Maintenance, Gainability, Marbling, Calving Ease.						
Wean Pct.	46%							
Cow Eff.	97							

## 191 WCRA Likable K204

A 100% # 4659675 Tat: WCRA2K204

Birth: 3-18-22

Beckton Likable Z057 L4 < Beckton Likable X445 J3  
Beckton Minola X107 L

**Beckton Likable B032 C5**

Ref. L-1 < Beckton Clifftop W577 E3  
Beckton Mona U584 CD

Beckton Julian A434 N6 < Beckton Julian X465 J5  
Beckton Lakme T689 NX

**WCRA Pine Marie G150 J**

Beckton Nebula P P707 < Beckton Nebula P P707  
Carpenter Pine Marie B003 N < BKT Pine Marie Z513 W

BWt	54
WR	97
YWt.	954
YR	104
FebADG	3.59
Frame	4.5
Feet	Good

DAM	Calv.Ease	BW	WW	YW	Milk	HPG	Stay	Maint.En.
Age	3							
Wt	905	EPDs	17	-4.2	59	111	21	15
Prog. BW	54	Marb	+0.62		REA	-0.10		Bfat
WR	97	Beef Tenderness	→ DNA: NA / NA		Scan:	1.9 / Tender		
YR	104	HerdBuilder Index:	51	Pct.: 48%	ProS:	125	Pct.: 9%	
Udder	NA	★★★★★ for Gainability, Marbling, Calving Ease.						
Wean Pct.	53%							
Cow Eff.	NA							

\*Note: Scrotal and ultrasound data will be available later

## 192 Beckton Accent K714 E5

1-A 100% # 4676631 Tat: BSF2 K714

Birth: 4-17-22

Beckton Accent E172 L3 < Beckton Accent W180 C2  
Beckton Indigo Y406 L

**Beckton Accent G107 C4**

Ref. A-5 < Beckton Pine Marie E206 D < TR Double Eagle ZT220  
BKT Pine Marie W404 J

Beckton Epic C776 J6 < Beckton Epic X464 L5  
Beckton Sierra Y058 J

**Beckton Barmaid E190 E**

< Beckton New Era Y194  
Beckton Barmaid C194 N < Beckton Barmaid X654 N

BWt	75
WR	94
YWt.	997
YR	100
FebADG	3.30
Frame	5.0
Feet	Good

DAM	
Age	5
Wt	1100
Prog. BW	66
WR	99
YR	98
Udder	NA
Wean Pct.	42%
Cow Eff.	87

Calv.Ease	BW	WW	YW	Milk	HPG	Stay	Maint.En.	
EPDs	17	-4.3	56	93	30	11	21	-3.0
Marb	+0.47		REA +0.11		Bfat +0.03			
Beef Tenderness	→ DNA: 10 / Outstanding		Scan: 2.0 / Tender					
HerdBuilder Index:	89	Pct.: 4%	ProS: 152		Pct.: 1%			

★★★★★ for Low Maintenance, Marbling, Calving Ease.

## 195 Beckton Accent K683 S4

1-A 100% # 4675649 Tat: BKT2 K683

Birth: 4-15-22

Beckton Accent W180 C2 < Beckton Cody K1 P014  
Beckton Christy R046 CQ

**Beckton Accent B740 W3**

Ref. A-3 < Beckton Lana Y033 W < Beckton Warrior W534 N4  
Beckton Lana W370 E

Beckton Scamp B720 L4 < Beckton Scamp X458 H3  
Beckton Larkaba Y448 L

**Beckton Indigo F643 S**

< Beckton Nebula T398 V3  
Beckton Indigo A849 N < Beckton Indigo U465 EP

BWt	52
WR	104
YWt.	990
YR	98
FebADG	2.77
Frame	5.0
Feet	Good

DAM	
Age	4
Wt	900
Prog. BW	58
WR	107
YR	108
Udder	Good
Wean Pct.	52%
Cow Eff.	109

Calv.Ease	BW	WW	YW	Milk	HPG	Stay	Maint.En.	
EPDs	22	-7.6	57	91	27	10	15	5.0
Marb	+0.44		REA +0.19		Bfat +0.03			
Beef Tenderness	→ DNA: 8 / Very Good		Scan: 1.5 / Tender +					
HerdBuilder Index:	58	Pct.: 44%	ProS: 85		Pct.: 62%			

★★★★★ for Marbling, Rib-eye area, Superior Cow, Calving Ease.

## 193 Beckton Julian K576 E8

1-A 100% # 4675875 Tat: BKT2 K576

Birth: 4-5-22

Beckton Julian D551 C6 < Beckton Julian X465 J5  
Beckton Tamara W550 A

**Beckton Julian F067 L7**

Ref. J-4 < Beckton Indigo D786 L < Beckton Likable Z057 L4  
Beckton Indigo Y026 N

Beckton Epic B310 J6 < Beckton Epic X464 L5  
Beckton Minerva Y116 J

**Beckton Coca G618 E**

< Beckton New Era Y194  
Beckton Coca C564 N < Beckton Coca T363 JL

BWt	60
WR	104
YWt.	1010
YR	103
FebADG	3.52
Frame	4.5
Feet	Good

DAM	
Age	3
Wt	820
Prog. BW	54
WR	101
YR	101
Udder	Very Good
Wean Pct.	51%
Cow Eff.	108

Calv.Ease	BW	WW	YW	Milk	HPG	Stay	Maint.En.	
EPDs	17	-3.8	59	107	27	14	13	6.0
Marb	+0.55		REA +0.00		Bfat +0.03			
Beef Tenderness	→ DNA: 9 / Outstanding		Scan: 1.6 / Tender +					
HerdBuilder Index:	37	Pct.: 83%	ProS: 100		Pct.: 37%			

★★★★★ for Gainability, Marbling, Calving Ease.

## 196 Beckton Scamp K131 L7

1-A 100% # 4676127 Tat: BKT2 K131

Birth: 3-4-22

Beckton Scamp F172 N5 < Beckton Scamp B720 L4  
Beckton Angel X450 N

**Beckton Scamp H076 E6**

Ref. S-4 < Beckton Larkaba F349 E < Beckton Epic B310 J6  
Beckton Larkaba B409 L

Beckton Likable B032 C5 < Beckton Likable Z057 L4  
Beckton Mona Z270 C

**Beckton Minerva H459 L**

< Beckton Likable U130 L2  
Beckton Minerva A244 E

BWt	54
WR	96
YWt.	958
YR	97
FebADG	3.37
Frame	5.0
Feet	Good

DAM	
Age	2
Wt	815
Prog. BW	54
WR	96
YR	97
Udder	Very Good
Wean Pct.	46%
Cow Eff.	97

Calv.Ease	BW	WW	YW	Milk	HPG	Stay	Maint.En.	
EPDs	19	-4.9	56	97	26	13	15	6.0
Marb	+0.34		REA +0.06		Bfat +0.02			
Beef Tenderness	→ DNA: 9 / Outstanding		Scan: 2.7 / Tender -					
HerdBuilder Index:	57	Pct.: 47%	ProS: 94		Pct.: 47%			

★★★★★ for Marbling, Calving Ease.

## 194 Beckton President K412 A2

1-A 100% # 4675887 Tat: BKT2 K412

Birth: 3-27-22

LSF SRR Commander 5906C < HXC Conquest 4405P  
LSF Crystal R5145 X0414

**LSF SRR President 8177F**

Ref. O-3 < LSF SRR Flo-Marie 961 D645 < Messmer Packer S008  
LSF Della P4078 U8051

Beckton Accent B653 C3 < Beckton Accent U777 C2  
Beckton Christy W779 C

**Beckton Maiata G670 A**

< Beckton Warrior Y108 E5  
Beckton Maiata C343 W < Beckton Maiata Y201 A

BWt	65
WR	98
YWt.	947
YR	97
FebADG	3.36
Frame	5.0
Feet	Good

DAM	
Age	3
Wt	930
Prog. BW	63
WR	98
YR	97
Udder	Very Good
Wean Pct.	45%
Cow Eff.	95

Calv.Ease	BW	WW	YW	Milk	HPG	Stay	Maint.En.	
EPDs	16	-4.6	58	86	30	15	18	-9.0
Marb	+0.65		REA +0.18		Bfat +0.03			
Beef Tenderness	→ DNA: 10 / Outstanding		Scan: 1.4 / Tender +					
HerdBuilder Index:	93	Pct.: 3%	ProS: 140		Pct.: 3%			

★★★★★ for Low Maintenance, Marbling, Rib-eye area, Calving Ease.



Lot 196

**197****Beckton Accent K837 L4**

1-A 100% # 4675775 Tat: BKT2 K837



Birth: 5-1-22

Beckton Accent W180 C2 < Beckton Cody K1 P014  
 Beckton Christy R046 CQ  
**Beckton Accent F602 L3**  
 Ref. A-4 Beckton Lana B670 L < Beckton Likable U130 L2  
 Beckton Lana Y541 W  
 Beckton Legend Z689 J3 < Beckton Legend X561 J2  
**Beckton Lana G406 L** < Beckton Larkaba W868 J  
 Beckton Lana W748 D < Beckton Dominor Z1 R610  
 Beckton Lana S858 JL

BWt 68  
 WR 110  
 YWt. 1037  
 YR 106  
 FebADG 2.80  
 Frame 5.0  
 Feet Good

DAM		Calv.Ease	BW	WW	YW	Milk	HPG	Stay	Maint.En.	
Age	3	EPDs	16	-2.7	64	99	27	14	18	-4.0
Wt	960	Marb	+32		REA	+25		Bfat	+03	
Prog. BW	62	Beef Tenderness →	DNA: 9 / Outstanding		Scan:	1.5 / Tender +				
WR	106	HerdBuilder Index:	89	Pct.: 4%	ProS:	104	Pct.: 31%			
YR	105	★★★★★ for Low Maintenance, Growth, Marbling, Rib-eye area, Superior Cow, Calving Ease.								
Udder	Very Good									
Wean Pct.	50%									
Cow Eff.	104									

**200****Beckton Warrior K619 A8**

1-A 100% # 4675735 Tat: BKT2 K619



Birth: 4-9-22

Beckton Warrior D359 L6 < Beckton Warrior Y108 E5  
 Beckton Lana W463 L  
**Beckton Warrior G356 N7**  
 Ref. W-1 Beckton Larkaba B277 N < Beckton New Era Y194  
 Beckton Larkaba U062 CB  
 Beckton Cody K1 P014 < Beckton Christy R046 CQ  
**Beckton Pine Marie F192 A**  
 Beckton Accent W180 C2 < Beckton Nebula P P707  
 BKT Pine Marie U621 NB < BKT Pine Marie P475 LN

BWt 78  
 WR 89  
 YWt. 977  
 YR 98  
 FebADG 3.17  
 Frame 5.0  
 Feet Good

DAM		Calv.Ease	BW	WW	YW	Milk	HPG	Stay	Maint.En.	
Age	4	EPDs	14	-3.4	55	93	26	13	18	-1.0
Wt	1140	Marb	+32		REA	-09		Bfat	+03	
Prog. BW	61	Beef Tenderness →	DNA: 9 / Outstanding		Scan:	2.0 / Tender				
WR	99	HerdBuilder Index:	60	Pct.: 42%	ProS:	101	Pct.: 36%			
YR	101	★★★★★ for Low Maintenance, Marbling, Calving Ease.								
Udder	Very Good									
Wean Pct.	36%									
Cow Eff.	76									

**198****Beckton Lancer K577 L2**

1-A 100% # 4675889 Tat: BKT2 K577



Birth: 4-5-22

Redhill U199 Lancer 9B < Buf Crk The Right Kind U199  
 Buf Crk Redpride P154  
**Redhill 9B Lancer 11E**  
 Ref. O-1 Redhill T189 Barmaid 190W < Buf Crk Nice'N Easy T189  
 1BWJ Barmaid 54P  
 Beckton Likable B032 C5 < Beckton Likable Z057 L4  
 Beckton Mona Z270 C  
**Beckton Coca G309 L** < Beckton New Era Y194  
 Beckton Coca Y114 N

BWt 59  
 WR 99  
 YWt. 995  
 YR 102  
 FebADG 3.46  
 Frame 5.0  
 Feet Good

DAM		Calv.Ease	BW	WW	YW	Milk	HPG	Stay	Maint.En.	
Age	3	EPDs	13	-3.5	61	101	26	15	14	9.0
Wt	905	Marb	+52		REA	-22		Bfat	+04	
Prog. BW	61	Beef Tenderness →	DNA: 9 / Outstanding		Scan:	1.8 / Tender				
WR	98	HerdBuilder Index:	36	Pct.: 84%	ProS:	82	Pct.: 67%			
YR	99	★★★★★ for Marbling, Calving Ease.								
Udder	Very Good									
Wean Pct.	47%									
Cow Eff.	99									

**201****Beckton Accent K549 E4**

1-A 100% # 4675769 Tat: BKT2 K549



Birth: 4-3-22

Beckton Accent B553 L2 < Beckton Accent U777 C2  
 Beckton Lana X839 L  
**Beckton Accent G208 N3**  
 Ref. A-6 Beckton Sierra A836 N < Beckton New Era Y194  
 Beckton Sierra S847 WR  
 Beckton Epic D002 E8 < Beckton Epic B545 N7  
 Beckton Christy B701 E  
**Beckton Lana F006 E** < Beckton Ranger B006 D5  
 Beckton Lana B028 R

BWt 71  
 WR 98  
 YWt. 963  
 YR 96  
 FebADG 2.86  
 Frame 5.0  
 Feet Good

DAM		Calv.Ease	BW	WW	YW	Milk	HPG	Stay	Maint.En.	
Age	4	EPDs	13	-1.3	63	106	25	NA	14	6.0
Wt	955	Marb	+44		REA	+15		Bfat	+03	
Prog. BW	70	Beef Tenderness →	DNA: 7 / Very Good		Scan:	1.7 / Tender				
WR	102	HerdBuilder Index:	36	Pct.: 84%	ProS:	78	Pct.: 73%			
YR	102	★★★★★ for Marbling, Rib-eye area, Calving Ease.								
Udder	Very Good									
Wean Pct.	46%									
Cow Eff.	96									

**199****Beckton Jet K305 N3**

1-A 100% # 4675143 Tat: BKT2 K305



Birth: 3-20-22

Beckton Jet L P491 < TR Julian Lt151  
 Beckton Minerva L278 LN  
**Beckton Jet G441 N2**  
 Ref. J-5 Beckton Susan B246 N < Beckton New Era Y194  
 Beckton Susan R022 CQ  
 Beckton Nebula L P093 < Beckton Nebula L P093  
 Beckton Minerva J615 VG  
**Beckton Lana Y726 N** < Beckton Nebula E P084  
 Beckton Lana T348 NB < Beckton Lana M167 LN

BWt 53  
 WR 86  
 YWt. 927  
 YR 93  
 FebADG 2.86  
 Frame 5.0  
 Feet Good

DAM		Calv.Ease	BW	WW	YW	Milk	HPG	Stay	Maint.En.	
Age	11	EPDs	20	-8.7	42	65	30	11	21	-2.0
Wt	1050	Marb	+46		REA	-08		Bfat	+04	
Prog. BW	64	Beef Tenderness →	DNA: 7 / Very Good		Scan:	1.1 / Tender +				
WR	96	HerdBuilder Index:	89	Pct.: 4%	ProS:	119	Pct.: 14%			
YR	100	★★★★★ for Low Maintenance, Marbling, Calving Ease.								
Udder	Good									
Wean Pct.	38%									
Cow Eff.	80									

**202****BSF Oracle K880 J2**

1-B 99% # 4676567 Tat: BSF2 K880



Birth: 5-11-22

Schuler Sudden Impact 0004X < Red Crowfoot Ole's Oscar  
 SOR Duchess TS 8915U  
**Schuler Oracle-7142E**  
 Ref. O-2 Sor Marlee Cmmtmnt 0470X < Brown Commitment S7206  
 SOR Marlee Beef 4511P  
 Beckton Julian Z382 J7 < Beckton Julian X721 E6  
 Beckton Larkaba X064 J  
**BSF Laurel D235 J** < Beckton Cherokee N N479  
 BSF Laurel U202 CQ < BSF Laurel N839 LN

BWt 73  
 WR 104  
 YWt. 1004  
 YR 101  
 FebADG 2.48  
 Frame 5.0  
 Feet Good

DAM		Calv.Ease	BW	WW	YW	Milk	HPG	Stay	Maint.En.	
Age	6	EPDs	18	-4.0	60	102	24	12	18	-1.0
Wt	1120	Marb	+63		REA	+21		Bfat	+03	
Prog. BW	66	Beef Tenderness →	DNA: 10 / Outstanding		Scan:	2.0 / Tender				
WR	103	HerdBuilder Index:	88	Pct.: 4%	ProS:	147	Pct.: 2%			
YR	103	★★★★★ for Low Maintenance, Marbling, Rib-eye area, Calving Ease.								
Udder	Very Good									
Wean Pct.	45%									
Cow Eff.	95									

\*Note: Scrotal and ultrasound data will be available later

## 203 Beckton Julian K923 N9

1-A 100% # 4675127 Tat: BKT2 K923

Birth: 5-28-22

Beckton Julian Z382 J7

**Beckton Julian E423 N8**

Ref. J-3

Beckton Belga B004 N

Beckton Nebula T269 E2

**BKT Pine Marie X339 N**

BKT Pine Marie S467 JE

Beckton Julian X721 E6

Beckton Larkaba X064 J

Beckton Nebula Z111 N5

Beckton Belga Z031 N

Beckton Nebula M045

Beckton Ruth M967 EP

Beckton Jules L429

BKT Pine Marie M119 EP



BWt	NA
WR	116
YWt.	1075
YR	107
FebADG	3.02
Frame	5.0
Feet	Good

DAM		Calv.Ease	BW	WW	YW	Milk	HPG	Stay	Maint.En.	
Age	12	EPDs	17	-5.3	55	90	32	13	17	2.0
Wt	1120	Marb	+0.42		REA	-0.20		Bfat	+0.05	
Prog. BW	74	Beef Tenderness →	DNA: 9 / Outstanding		Scan:	1.4 / Tender +				
WR	109	HerdBuilder Index:	68	Pct.: 26%	ProS:	93	Pct.: 49%			
YR	108	★★★★★ for Growth, Marbling, Superior Cow, Calving Ease.								
Udder	Very Good									
Wean Pct.	50%									
Cow Eff.	105									

## 205 WCRA Likable K205

A 100% # 4659665 Tat: WCRA2K205

Birth: 3-21-22

Beckton Likable Z057 L4

**Beckton Likable B032 C5**

Ref. L-1

Beckton Mona Z270 C

Beckton Accent W180 C2

**WCRA Christy F137 A**

Beckton Christy Z390 J

Beckton Likable X445 J3

Beckton Minola X107 L

Beckton Clifftop W577 E3

Beckton Mona U584 CD

Beckton Cody K1 P014

Beckton Christy R046 CQ

Beckton Julian G5 S107

Beckton Christy S192 LN



BWt	61
WR	98
YWt.	915
YR	99
FebADG	3.68
Frame	5.0
Feet	Good

DAM		Calv.Ease	BW	WW	YW	Milk	HPG	Stay	Maint.En.	
Age	4	EPDs	17	-5.1	51	92	24	15	15	9.0
Wt	1090	Marb	+0.46		REA	-0.05		Bfat	+0.03	
Prog. BW	61	Beef Tenderness →	DNA: NA / NA		Scan:	1.5 / Tender +				
WR	95	HerdBuilder Index:	41	Pct.: 69%	ProS:	88	Pct.: 57%			
YR	95	★★★★★ for Gainability, Marbling, Calving Ease.								
Udder	Very Good									
Wean Pct.	45%									
Cow Eff.	NA									

## 204 Beckton Jet K585 J3

1-A 100% # 4675179 Tat: BKT2 K585

Birth: 4-6-22

Beckton Jet L P491

**Beckton Jet G441 N2**

Ref. J-5

Beckton Susan B246 N

Beckton Julian GG B571

**Beckton Rose Z419 J**

Beckton Rose W833 N

TR Julian Lt151

Beckton Minerva L278 LN

Beckton New Era Y194

Beckton Susan R022 CQ

Beckton Julian 7526G

Bkt Marta 9A13 JL

Beckton Nebula G S237

Beckton Rose R579 JJ



BWt	62
WR	82
YWt.	950
YR	95
FebADG	3.65
Frame	5.0
Feet	Good

DAM		Calv.Ease	BW	WW	YW	Milk	HPG	Stay	Maint.En.	
Age	10	EPDs	21	-8.1	45	72	25	13	16	-8.0
Wt	1100	Marb	+0.53		REA	-0.18		Bfat	+0.03	
Prog. BW	62	Beef Tenderness →	DNA: 8 / Very Good		Scan:	2.1 / Tender				
WR	96	HerdBuilder Index:	63	Pct.: 35%	ProS:	104	Pct.: 31%			
YR	100	★★★★★ for Low Maintenance, Gainability, Marbling, Calving Ease.								
Udder	Good									
Wean Pct.	36%									
Cow Eff.	76									

## 206 Beckton Scamp K871 N7

1-B 99% # 4676507 Tat: BFS2 K871

Birth: 5-9-22

Beckton Scamp D325 N5

**Beckton Scamp G236 L6**

Ref. S-3

Beckton Indigo Y406 L

Beckton Nebula A773 L4

**BSF Nebulann D554 N**

BSF Nebulann A433 N

Beckton Scamp A627 J4

Beckton Tamara Y039 N

Beckton Likable U130 L2

Beckton Indigo R745 WR

Beckton Nebula T398 V3

Beckton Mona X022 L

Beckton Nebula W778 J4

BSF Nebulann U242 NB



BWt	77
WR	103
YWt.	996
YR	100
FebADG	3.52
Frame	5.5
Feet	Good

DAM		Calv.Ease	BW	WW	YW	Milk	HPG	Stay	Maint.En.	
Age	6	EPDs	14	-2.9	59	90	27	NA	18	-4.0
Wt	1045	Marb	+0.32		REA	-0.04		Bfat	+0.02	
Prog. BW	77	Beef Tenderness →	DNA: 10 / Outstanding		Scan:	2.5 / Tender				
WR	102	HerdBuilder Index:	81	Pct.: 9%	ProS:	96	Pct.: 43%			
YR	97	★★★★★ for Low Maintenance, Gainability, Marbling, Calving Ease.								
Udder	Very Good									
Wean Pct.	48%									
Cow Eff.	101									



Lot 202

## 207 Beckton Cardinal K615 L2

1-A 100% # 4675857 Tat: BKT2 K615

Birth: 4-8-22

TR Double Eagle ZT220

**Beckton Cardinal E673 L**

Ref. C-1

Beckton Larkaba A911 L

Beckton Accent B740 W3

**Beckton Lana G611 A**

Beckton Lana B770 W

TR Ricardo DOS

Beckton Lana U182 JC

Beckton Legend U331 E2

Beckton Larkaba T418 WA

Beckton Accent W180 C2

Beckton Lana Y033 W

Beckton Warrior Z374 C6

Beckton Lana Z276 W



BWt	56
WR	109
YWt.	959
YR	98
FebADG	2.48
Frame	5.0
Feet	Good

DAM		Calv.Ease	BW	WW	YW	Milk	HPG	Stay	Maint.En.	
Age	3	EPDs	22	-6.9	62	99	30	13	16	2.0
Wt	900	Marb	+0.52		REA	+0.26		Bfat	+0.04	
Prog. BW	54	Beef Tenderness →	DNA: NA / NA		Scan:	1.5 / Tender +				
WR	112	HerdBuilder Index:	69	Pct.: 24%	ProS:	111	Pct.: 22%			
YR	102	★★★★★ for Marbling, Rib-eye area, Calving Ease.								
Udder	Very Good									
Wean Pct.	49%									
Cow Eff.	103									

\*Note: Scrotal and ultrasound data will be available later

**208****Beckton Scamp K365 E7**

1-A 100% # 4675983 Tat: BKT2 K365



Birth: 3-24-22

Beckton Scamp D325 N5 < Beckton Scamp A627 J4  
Beckton Scamp G236 L6 < Beckton Tamara Y039 N  
Ref. S-3 < Beckton Indigo Y406 L < Beckton Likable U130 L2  
< Beckton Indigo R745 WR  
Beckton Epic E599 L8 < Beckton Epic A587 N7  
Beckton Coca G090 E < Beckton Christy X005 L  
< Beckton Lancer F442 T  
< Beckton Coca B439 E3

BWt 69  
WR 90  
YWt. 949  
YR 97  
FebADG 3.33  
Frame 5.5  
Feet Good

DAM		Calv.Ease	BW	WW	YW	Milk	HPG	Stay	Maint.En.	
Age	3	EPDs	14	-3.2	55	93	24	NA	14	-6.0
Wt	870	Marb	+0.36		REA	+0.01		Bfat	+0.02	
Prog. BW	69	Beef Tenderness	→		DNA: 5 / Average	Scan: 1.6 / Tender +				
WR	99	HerdBuilder Index:	49	Pct.: 62%	ProS:	92	Pct.: 51%			
YR	102	★★★★★ for Low Maintenance, Marbling, Calving Ease.								
Udder	Very Good									
Wean Pct.	44%									
Cow Eff.	92									

**210****Beckton Cardinal K602 E2**

1-A 100% # 4675119 Tat: BKT2 K602



Birth: 4-8-22

TR Double Eagle ZT220 < TR Ricardo DOS  
Beckton Cardinal E673 L < Beckton Lana U182 JC  
Ref. C-1 < Beckton Legend U331 E2  
< Beckton Larkaba T418 WA  
Beckton Epic K6 S569 < Beckton Epic KM M115  
Beckton Rose X389 E < Beckton Sierra N703 LM  
< Beckton Lancer T7 M089  
< Beckton Rose M131 HR

BWt 62  
WR 99  
YWt. 951  
YR 95  
FebADG 2.97  
Frame 4.5  
Feet Good

DAM		Calv.Ease	BW	WW	YW	Milk	HPG	Stay	Maint.En.	
Age	12	EPDs	20	-6.1	56	87	31	12	17	0.0
Wt	1010	Marb	+0.45		REA	+0.02		Bfat	+0.03	
Prog. BW	72	Beef Tenderness	→		DNA: 6 / Average	Scan: 1.5 / Tender +				
WR	110	HerdBuilder Index:	75	Pct.: 15%	ProS:	109	Pct.: 25%			
YR	105	★★★★★ for Low Maintenance, Marbling, Superior Cow, Calving Ease.								
Udder	Very Good									
Wean Pct.	45%									
Cow Eff.	96									

**209****Beckton Dominor K354 E9**

1-A 100% # 4675833 Tat: BKT2 K354



Birth: 3-23-22

Beckton Dominor A378 W7 < Beckton Dominor Y005 V6  
Beckton Dominor F263 N8 < Beckton Lana Y541 W  
Ref. D-1 < Beckton Nebula EN S347  
< Beckton Larkaba W272 N < Beckton Larkaba N643 HR  
Beckton Epic B310 J6 < Beckton Epic X464 L5  
Beckton Minerva G196 E < Beckton Minerva Y116 J  
< Beckton Accent U777 C2  
< Beckton Minerva X047 N

BWt 66  
WR 104  
YWt. 996  
YR 102  
FebADG 3.19  
Frame 4.5  
Feet Good

DAM		Calv.Ease	BW	WW	YW	Milk	HPG	Stay	Maint.En.	
Age	3	EPDs	18	-3.4	58	94	35	15	15	1.0
Wt	925	Marb	+0.40		REA	+0.07		Bfat	+0.05	
Prog. BW	69	Beef Tenderness	→		DNA: 9 / Outstanding	Scan: 1.4 / Tender +				
WR	109	HerdBuilder Index:	67	Pct.: 27%	ProS:	99	Pct.: 40%			
YR	109	★★★★★ for Marbling, Superior Cow, Calving Ease.								
Udder	Very Good									
Wean Pct.	48%									
Cow Eff.	102									

**211****Beckton Jet K572 A3**

1-A 100% # 4675541 Tat: BKT2 K572



Birth: 4-5-22

Beckton Jet L P491 < TR Julian Lt151  
Beckton Jet G441 N2 < Beckton Minerva L278 LN  
Ref. J-5 < Beckton New Era Y194  
< Beckton Susan B246 N < Beckton Susan R022 CQ  
Beckton Accent A175 O3 < Beckton Accent W180 C2  
Beckton Larkeisa E239 A < Beckton Lana R214 RA  
< Beckton Epic X330 L6  
< Beckton Larkeisa Z556 E < Beckton Larkeisa X091 L

BWt 55  
WR 100  
YWt. 935  
YR 94  
FebADG 2.38  
Frame 4.5  
Feet Good

DAM		Calv.Ease	BW	WW	YW	Milk	HPG	Stay	Maint.En.	
Age	5	EPDs	21	-8.5	50	74	29	10	17	-1.0
Wt	1110	Marb	+0.43		REA	-0.12		Bfat	+0.03	
Prog. BW	62	Beef Tenderness	→		DNA: 9 / Outstanding	Scan: 1.5 / Tender +				
WR	102	HerdBuilder Index:	63	Pct.: 35%	ProS:	86	Pct.: 60%			
YR	98	★★★★★ for Low Maintenance, Marbling, Calving Ease.								
Udder	Very Good									
Wean Pct.	44%									
Cow Eff.	92									



Lot 209

**212****Beckton Scamp K863 A6**

1-A 100% # 4675611 Tat: BKT2 K863



Birth: 5-6-22

Beckton Scamp B720 L4 < Beckton Scamp X458 H3  
Beckton Scamp E175 N5 < Beckton Larkaba Y448 L  
Ref. S-1 < Beckton Nebula T398 V3  
< Beckton Belga W103 N < Beckton Belga T551 EP  
Beckton Accent C557 N4 < Beckton Accent Y312 N3  
Beckton Susan E030 A < Beckton Minerva Y654 N  
< Beckton Scamp A626 H3  
< Beckton Susan C047 S < Beckton Susan A112 S

BWt 74  
WR 113  
YWt. 1025  
YR 103  
FebADG 2.66  
Frame 5.0  
Feet Good

DAM		Calv.Ease	BW	WW	YW	Milk	HPG	Stay	Maint.En.	
Age	5	EPDs	17	-4.4	56	94	30	9	16	9.0
Wt	1005	Marb	+0.43		REA	+0.05		Bfat	+0.04	
Prog. BW	70	Beef Tenderness	→		DNA: 10 / Outstanding	Scan: 1.8 / Tender				
WR	108	HerdBuilder Index:	50	Pct.: 61%	ProS:	81	Pct.: 69%			
YR	102	★★★★★ for Marbling, Calving Ease.								
Udder	Very Good									
Wean Pct.	55%									
Cow Eff.	115									

\*Note: Scrotal and ultrasound data will be available later



## 213 Beckton Ranger K275 A7

1-A 100% # 4675465 Tat: BKT2 K275



Birth: 3-18-22

Beckton Ranger B006 D5 < Beckton Ranger Z225 J4  
Beckton Sufteina Z731 D

**Beckton Ranger G299 N6**

Ref. R-1 < Beckton Indigo C018 N < Beckton Nebula A773 L4  
Beckton Indigo A849 N

Beckton Accent U777 C2 < Beckton Cody K1 P014  
Beckton Susan R022 CQ

**Beckton Sufteina D277 A**

< Beckton Nebula W778 J4  
Beckton Sufteina W489 W

BWt	58
WR	91
YWt.	877
YR	88
FebADG	3.13
Frame	5.0
Feet	Good

DAM								
Age	6							
Wt	1100							
Prog. BW	59							
WR	103							
YR	101							
Udder	Very Good							
Wean Pct.	40%							
Cow Eff.	85							
Calv.Ease	BW	WW	YW	Milk	HPG	Stay	Maint.En.	
EPDs	21	-7.3	45	77	28	12	17	-1.0
Marb	+0.46		REA	-0.17		Bfat	+0.04	
Beef Tenderness	→		DNA: 8 / Very Good	Scan: 1.4 / Tender +				
HerdBuilder Index:	68	Pct.: 26%	ProS:	104	Pct.: 32%			
★★★★★ for Low Maintenance, Marbling, Calving Ease.								

## 216 Beckton Julian K761 L8

1-A 100% # 4675701 Tat: BKT2 K761



Birth: 4-22-22

Beckton Julian D551 C6 < Beckton Julian X465 J5  
Beckton Tamara W550 A

**Beckton Julian F067 L7**

Ref. J-4 < Beckton Indigo D786 L < Beckton Likable Z057 L4  
Beckton Indigo Y026 N

Beckton Likable B032 C5 < Beckton Likable Z057 L4  
Beckton Mona Z270 C

**Beckton Belga F305 L**

< Beckton Nebula T398 V3  
Beckton Belga S026 NB

BWt	68
WR	106
YWt.	936
YR	94
FebADG	4.16
Frame	5.0
Feet	Good

DAM								
Age	4							
Wt	1140							
Prog. BW	61							
WR	100							
YR	101							
Udder	Very Good							
Wean Pct.	43%							
Cow Eff.	91							
Calv.Ease	BW	WW	YW	Milk	HPG	Stay	Maint.En.	
EPDs	17	-4.0	59	110	24	14	16	14.0
Marb	+0.43		REA	-0.03		Bfat	+0.03	
Beef Tenderness	→		DNA: 7 / Very Good	Scan: 2.2 / Tender				
HerdBuilder Index:	47	Pct.: 66%	ProS:	103	Pct.: 32%			
★★★★★ for Gainability, Marbling, Calving Ease.								

## 214 Beckton Accent K864 L4

1-A 100% # 4675507 Tat: BKT2 K864



Birth: 5-6-22

Beckton Accent W180 C2 < Beckton Cody K1 P014  
Beckton Christy R046 CQ

**Beckton Accent B549 N3**

Ref. A-2 < Beckton Minerva Y654 N < Beckton Nebula T398 V3  
Beckton Minerva M369 L0

Beckton Likable Y124 L3 < Beckton Likable U130 L2  
BKT Pine Marie S802 L0

**Beckton Rose E499 L**

< Beckton Epic K6 S569  
Beckton Rose P015 LN

BWt	75
WR	109
YWt.	994
YR	100
FebADG	2.81
Frame	5.0
Feet	Good

DAM								
Age	5							
Wt	1045							
Prog. BW	65							
WR	104							
YR	102							
Udder	Very Good							
Wean Pct.	51%							
Cow Eff.	106							
Calv.Ease	BW	WW	YW	Milk	HPG	Stay	Maint.En.	
EPDs	16	-4.1	63	100	25	12	16	8.0
Marb	+0.39		REA	-0.06		Bfat	+0.04	
Beef Tenderness	→		DNA: 9 / Outstanding	Scan: 1.8 / Tender				
HerdBuilder Index:	60	Pct.: 40%	ProS:	85	Pct.: 62%			
★★★★★ for Marbling, Calving Ease.								

## 217 Beckton Likable K671 L4

1-A 100% # 4675259 Tat: BKT2 K671



Birth: 4-13-22

Beckton Likable U130 L2 < Beckton Likable S633  
Beckton Kit S478 LN

**Beckton Likable C229 R3**

Ref. L-2 < Beckton Tamara X447 J < Beckton Roman J S158  
Beckton Tamara R834 JC

Beckton Likable U130 L2 < Beckton Likable S633  
Beckton Kit S478 LN

**Beckton Pine Marie B170 L**

< BKT Pine Marie W102 C < BKT Clifftop TP R288  
BKT Pine Marie M119 EP

BWt	75
WR	105
YWt.	889
YR	88
FebADG	2.31
Frame	4.5
Feet	Good

DAM								
Age	8							
Wt	1180							
Prog. BW	70							
WR	89							
YR	95							
Udder	Very Good							
Wean Pct.	42%							
Cow Eff.	88							
Calv.Ease	BW	WW	YW	Milk	HPG	Stay	Maint.En.	
EPDs	13	-1.9	60	86	24	13	17	-3.0
Marb	+0.31		REA	+0.20		Bfat	+0.03	
Beef Tenderness	→		DNA: 9 / Outstanding	Scan: 1.4 / Tender +				
HerdBuilder Index:	72	Pct.: 19%	ProS:	73	Pct.: 80%			
★★★★★ for Low Maintenance, Marbling, Rib-eye area, Calving Ease.								

## 215 Beckton Scamp K223 L6

1-A 100% # 4675503 Tat: BKT2 K223



Birth: 3-15-22

Beckton Scamp B720 L4 < Beckton Scamp X458 H3  
Beckton Larkaba Y448 L

**Beckton Scamp E175 N5**

Ref. S-1 < Beckton Belga W103 N < Beckton Nebula T398 V3  
Beckton Belga T551 EP

Beckton Likable Y124 L3 < Beckton Likable U130 L2  
BKT Pine Marie S802 L0

**Beckton Lana E490 L**

< Beckton Nebula L P093  
Beckton Lana R450 LO

BWt	63
WR	91
YWt.	847
YR	85
FebADG	2.41
Frame	5.0
Feet	Good

DAM								
Age	5							
Wt	1090							
Prog. BW	56							
WR	95							
YR	90							
Udder	Very Good							
Wean Pct.	41%							
Cow Eff.	86							
Calv.Ease	BW	WW	YW	Milk	HPG	Stay	Maint.En.	
EPDs	19	-5.8	45	73	26	10	18	0.0
Marb	+0.39		REA	-0.19		Bfat	+0.03	
Beef Tenderness	→		DNA: 8 / Very Good	Scan: 1.9 / Tender				
HerdBuilder Index:	70	Pct.: 21%	ProS:	93	Pct.: 50%			
★★★★★ for Low Maintenance, Marbling, Calving Ease.								



Lot 217

# 218

## Beckton Likable K634 H4

1-A 100% # 4675755 Tat: BKT2 K634



Birth: 4-10-22

Beckton Likable U130 L2 < Beckton Likable S633  
 Beckton Likable E636 C3 < Beckton Kit S478 LN  
 Ref. L-3 < BKT Clifftop TP R288  
 Beckton Minola W808 C < Beckton Minola R604 CD  
 Beckton Hughes D589 S2 < Bieber H Hughes W109  
 Beckton Tamara F086 H < Beckton Sierra Z353 S  
 Beckton Tamara D483 L < Beckton Likable Z057 L4  
 Beckton Tamara A701 J

BWt 77  
 WR 108  
 YWt. 900  
 YR 89  
 FebADG 2.25  
 Frame 5.0  
 Feet Good

**DAM**  
 Age 4  
 Wt 1180  
 Prog. BW 75  
 WR 100  
 YR 89  
 Udder Very Good  
 Wean Pct. 41%  
 Cow Eff. 87

Calv.Ease	BW	WW	YW	Milk	HPG	Stay	Maint.En.
EPDs 13	-1.5	60	86	27	14	15	3.0
Marb +.38		REA +.21				Bfat +.03	
Beef Tenderness →	DNA: 10 / Outstanding					Scan: 1.8 / Tender	
HerdBuilder Index: 54	Pct.: 53%					ProS: 59	Pct.: 93%

★★★★★ for Marbling, Rib-eye area, Calving Ease.



Lot 218

# 219

## Beckton Warrior K473 N8

1-A 100% # 4675153 Tat: BKT2 K473



Birth: 3-30-22

Beckton Warrior D359 L6 < Beckton Warrior Y108 E5  
 Beckton Warrior G356 N7 < Beckton Lana W463 L  
 Ref. W-1 < Beckton New Era Y194  
 Beckton Larkaba B277 N < Beckton Larkaba U062 CB  
 Beckton Nebula W065 C3 < Beckton Nebula T269 E2  
 Beckton Lana Y024 N < Beckton Lana T104 CT  
 Beckton Lana W277 A < Beckton Cody K1 P014  
 Beckton Lana N869 LO

BWt 57  
 WR 104  
 YWt. 868  
 YR 86  
 FebADG 2.78  
 Frame 4.5  
 Feet Good

**DAM**  
 Age 11  
 Wt 1005  
 Prog. BW 61  
 WR 107  
 YR 103  
 Udder Very Good  
 Wean Pct. 46%  
 Cow Eff. 98

Calv.Ease	BW	WW	YW	Milk	HPG	Stay	Maint.En.
EPDs 19	-6.1	40	61	33	11	15	-2.0
Marb +.31		REA -.22				Bfat +.03	
Beef Tenderness →	DNA: 9 / Outstanding					Scan: 1.8 / Tender	
HerdBuilder Index: 57	Pct.: 47%					ProS: 64	Pct.: 89%

★★★★★ for Low Maintenance, Marbling, Calving Ease.



Lot 220

# 220

## Beckton New Era K168 L4

1-A 100% # 4676655 Tat: BSF2 K468



Birth: 3-30-22

Beckton Nebula P P707 < Beckton Nebula M045  
 Beckton New Era Y194 < Beckton Lana M809 EP  
 Ref. N-1 < BKT Larkeisa T310 JC  
 Beckton Likable B509 J3 < Beckton Justice C1 R483  
 Beckton Coca F794 L < BKT Larkeisa R775 JC  
 Beckton Coca B529 C < Beckton Likable U130 L2  
 Beckton Coca X558 E < Beckton Coca T363 JL  
 Beckton Clifftop W692 E3  
 Beckton Coca X558 E

BWt 60  
 WR 89  
 YWt. 929  
 YR 93  
 FebADG 2.98  
 Frame 4.5  
 Feet Good

**DAM**

Calv.Ease	BW	WW	YW	Milk	HPG	Stay	Maint.En.
EPDs 18	-5.8	46	73	29	12	17	-2.0
Marb +.34		REA -.08				Bfat +.04	
Beef Tenderness →	DNA: 7 / Very Good					Scan: 1.7 / Tender	
HerdBuilder Index: 53	Pct.: 55%					ProS: 86	Pct.: 60%

★★★★★ for Low Maintenance, Marbling, Calving Ease.

# 221

## Beckton Nebula K122 N6

1-A 100% # 4676045 Tat: BKT2 K122



Birth: 3-3-22

Beckton Nebula A773 L4 < Beckton Nebula T398 V3  
 Beckton Nebula H566 L5 < Beckton Mona X022 L  
 Ref. N-5 < Beckton Likable A306 L3  
 Beckton Maiata C031 L < Beckton Maiata A091 C  
 Beckton Nebula A773 L4 < Beckton Nebula T398 V3  
 Beckton Ruth H658 N < Beckton Mona X022 L  
 Beckton Ruth X041 J < Beckton Jet U473 L2  
 Beckton Ruth U557 JT

BWt 63  
 WR 92  
 YWt. 957  
 YR 97  
 FebADG 3.24  
 Frame 4.5  
 Feet Good

**DAM**

Calv.Ease	BW	WW	YW	Milk	HPG	Stay	Maint.En.
EPDs 12	-1.6	57	92	29	NA	22	6.0
Marb +.38		REA -.05				Bfat +.02	
Beef Tenderness →	DNA: 9 / Outstanding					Scan: 1.4 / Tender +	
HerdBuilder Index: 84	Pct.: 7%					ProS: 125	Pct.: 9%

★★★★★ for Marbling, Calving Ease.

\*Note: Scrotal and ultrasound data will be available later

## 222 Beckton Scamp K766 L6

1-A 100% # 4675927 Tat: BKT2 K766



Birth: 4-23-22

Beckton Scamp B720 L4 < Beckton Scamp X458 H3  
Beckton Larkaba Y448 L

**Beckton Scamp E175 N5**  
Ref. S-1 < Beckton Nebula T398 V3  
Beckton Belga W103 N < Beckton Belga T551 EP

**Beckton Lana G032 O**  
< Redhill 9B Lancer 11E < Redhill U199 Lancer 9B  
< Redhill T189 Barmaid 190W

Beckton Lana E490 L < Beckton Likable Y124 L3  
Beckton Lana W696 N

BWt	63
WR	104
YWt.	962
YR	98
FebADG	2.67
Frame	5.5
Feet	Good

DAM	
Age	3
Wt	945
Prog. BW	65
WR	108
YR	102
Udder	Very Good
Wean Pct.	47%
Cow Eff.	99

Calv.Ease	BW	WW	YW	Milk	HPG	Stay	Maint.En.	
EPDs	16	-4.1	59	96	28	12	17	8.0
Marb	+4.8		REA		-0.7	Bfat		+0.3
Beef Tenderness	→		DNA: 9 / Outstanding		Scan: 2.3 / Tender			
HerdBuilder Index:	57	Pct.: 46%	ProS: 92		Pct.: 51%			

★★★★★ for Marbling, Calving Ease.

## 225 Beckton Scamp K383 C7

1-A 100% # 4676701 Tat: BSF2 K383



Birth: 3-26-22

Beckton Scamp D325 N5 < Beckton Scamp A627 J4  
Beckton Tamara Y039 N

**Beckton Scamp G236 L6**  
Ref. S-3 < Beckton Likable U130 L2  
Beckton Indigo Y406 L < Beckton Indigo R745 WR

**Beckton Sierra F304 C**  
< Beckton Clifftop D059 C5 < Beckton Clifftop B848 J4  
Beckton Larkaba B565 C < Beckton Likable Z057 L4  
Beckton Sierra Z069 L

BWt	60
WR	92
YWt.	923
YR	93
FebADG	2.23
Frame	5.0
Feet	Good

DAM	
Age	4
Wt	800
Prog. BW	58
WR	97
YR	93
Udder	Very Good
Wean Pct.	53%
Cow Eff.	112

Calv.Ease	BW	WW	YW	Milk	HPG	Stay	Maint.En.	
EPDs	19	-6.3	43	69	28	11	13	-10.0
Marb	+3.8		REA		+0.4	Bfat		+0.1
Beef Tenderness	→		DNA: 10 / Outstanding		Scan: 1.7 / Tender			
HerdBuilder Index:	47	Pct.: 67%	ProS: 71		Pct.: 83%			

★★★★★ for Low Maintenance, Marbling, Calving Ease.

## 223 Beckton Dominor K212 L8

1-A 100% # 4676279 Tat: BKT2 K212



Birth: 3-13-22

Beckton Dominor Y052 N6 < Beckton Dominor W640 C5  
Beckton Indigo W772 N

**Beckton Dominor H382 N7**  
Ref. D-3 < Beckton Nebula Z111 N5  
Beckton Coca E847 N < Beckton Coca A271 N

**Beckton Indigo H033 L**  
< Beckton Likable F520 N5 < Beckton Likable Z057 L4  
Beckton Sierra A836 N < Beckton Heritage D195 L4  
Beckton Indigo F114 H < Beckton Indigo C018 N

BWt	52
WR	103
YWt.	960
YR	99
FebADG	3.08
Frame	5.0
Feet	Good

DAM	
Age	2
Wt	760
Prog. BW	52
WR	103
YR	99
Udder	Very Good
Wean Pct.	49%
Cow Eff.	104

Calv.Ease	BW	WW	YW	Milk	HPG	Stay	Maint.En.	
EPDs	14	-4.0	65	109	26	13	16	7.0
Marb	+5.0		REA		-0.4	Bfat		+0.4
Beef Tenderness	→		DNA: 7 / Very Good		Scan: 1.4 / Tender +			
HerdBuilder Index:	45	Pct.: 70%	ProS: 90		Pct.: 53%			

★★★★★ for Marbling, Calving Ease.

## 226 Beckton Jet K488 N3

1-A 100% # 4676315 Tat: BSF2 K488



Birth: 3-31-22

Beckton Jet L P491 < TR Julian Lt151  
Beckton Minerva L278 LN

**Beckton Jet G441 N2**  
Ref. J-5 < Beckton New Era Y194  
Beckton Susan B246 N < Beckton Susan R022 CQ

**Beckton Barmaid X231 N**  
< Beckton Nebula T269 E2 < Beckton Nebula M045  
Beckton Ruth M967 EP < Beckton Lancer T A664  
Beckton Barmaid G565 LN < Bkt Barmaid 9517 RN

BWt	58
WR	89
YWt.	920
YR	92
FebADG	2.92
Frame	4.5
Feet	Good

DAM	
Age	12
Wt	935
Prog. BW	64
WR	101
YR	98
Udder	Very Good
Wean Pct.	44%
Cow Eff.	93

Calv.Ease	BW	WW	YW	Milk	HPG	Stay	Maint.En.	
EPDs	21	-9.5	30	43	30	11	17	-8.0
Marb	+5.3		REA		-0.28	Bfat		+0.3
Beef Tenderness	→		DNA: 10 / Outstanding		Scan: 1.4 / Tender +			
HerdBuilder Index:	71	Pct.: 20%	ProS: 93		Pct.: 49%			

★★★★★ for Low Maintenance, Marbling, Calving Ease.

## 224 Beckton Oracle K331 D3

1-A 100% # 4675695 Tat: BKT2 K331



Birth: 3-22-22

Schuler Oracte-7142E < Schuler Sudden Impact 0004X  
Sor Marlee Cmmmtnt 0470X

**Beckton Oracle G222 J2**  
Ref. O-4 < Beckton Julian GG B571  
Beckton Rose W346 E

**Beckton Maiata F342 D**  
< TR Double Eagle ZT220 < TR Ricardo DOS  
Beckton Lana U182 JC < Beckton Accent W180 C2  
Beckton Maiata Y201 A < Beckton Maiata W189 J

BWt	58
WR	89
YWt.	896
YR	90
FebADG	2.67
Frame	5.0
Feet	Good

DAM	
Age	4
Wt	915
Prog. BW	61
WR	101
YR	98
Udder	Very Good
Wean Pct.	45%
Cow Eff.	95

Calv.Ease	BW	WW	YW	Milk	HPG	Stay	Maint.En.	
EPDs	22	-7.5	42	65	29	11	20	0.0
Marb	+6.2		REA		+0.3	Bfat		+0.3
Beef Tenderness	→		DNA: 7 / Very Good		Scan: 1.9 / Tender			
HerdBuilder Index:	87	Pct.: 5%	ProS: 136		Pct.: 4%			

★★★★★ for Low Maintenance, Marbling, Calving Ease.



Lot 224

\*Note: Scrotal and ultrasound data will be available later

**227****Beckton Scamp K821 J6**

1-A 100% # 4675337 Tat: BKT2 K821



Birth: 4-29-22

Beckton Scamp B720 L4 < Beckton Scamp X458 H3  
 Beckton Scamp E175 N5 < Beckton Larkaba Y448 L  
 Ref. S-1 < Beckton Nebula T398 V3  
 Beckton Belga W103 N < Beckton Belga T551 EP  
 Beckton Julian GG B571 < Beckton Julian 7526G  
 Beckton Angel C791 J < Bkt Marta 9A13 JL  
 Beckton Angel T652 NB < Beckton Nebula L P093  
 Beckton Angel H164 LO

BWt 53  
 WR 93  
 YWt. 981  
 YR 98  
 FebADG 2.98  
 Frame 5.0  
 Feet Good

**DAM**  
 Age 7  
 Wt 1045  
 Prog. BW 64  
 WR 102  
 YR 105  
 Udder Very Good  
 Wean Pct. 43%  
 Cow Eff. 91

Calv.Ease	BW	WW	YW	Milk	HPG	Stay	Maint.En.
EPDs 20	-6.7	51	89	27	12	17	1.0
Marb +.44		REA +.07				Bfat +.03	
Beef Tenderness →	DNA: 10 / Outstanding	Scan: 1.6 / Tender +					
HerdBuilder Index: 65	Pct.: 32%	ProS: 116	Pct.: 16%				

★★★★★ for Marbling, Calving Ease.

**228****Beckton Accent K599 L4**

1-A 100% # 4675871 Tat: BKT2 K599



Birth: 4-7-22

Beckton Accent W180 C2 < Beckton Cody K1 P014  
 Beckton Accent F602 L3 < Beckton Christy R046 CQ  
 Ref. A-4 < Beckton Likable U130 L2  
 Beckton Lana B670 L < Beckton Lana Y541 W  
 Beckton Likable B032 C5 < Beckton Likable Z057 L4  
 Beckton Lana G344 L < Beckton Mona Z270 C  
 Beckton Lana C676 A < Beckton Accent Y260 L3  
 Beckton Lana Z724 A

BWt 58  
 WR 95  
 YWt. 924  
 YR 94  
 FebADG 3.21  
 Frame 5.0  
 Feet Good

**DAM**  
 Age 3  
 Wt 850  
 Prog. BW 58  
 WR 96  
 YR 96  
 Udder NA  
 Wean Pct. 47%  
 Cow Eff. 100

Calv.Ease	BW	WW	YW	Milk	HPG	Stay	Maint.En.
EPDs 18	-5.9	52	89	24	13	18	-4.0
Marb +.48		REA +.08				Bfat +.03	
Beef Tenderness →	DNA: 9 / Outstanding	Scan: 2.1 / Tender					
HerdBuilder Index: 81	Pct.: 9%	ProS: 121	Pct.: 12%				

★★★★★ for Low Maintenance, Marbling, Calving Ease.

**229****Beckton Nebula K271 E5**

1-A 100% # 4676453 Tat: BSF2 K271



Birth: 3-18-22

Beckton Nebula B557 J3 < Beckton Nebula P P707  
 Beckton Nebula G249 N4 < Beckton Larkaba T813 JC  
 Ref. N-4 < Beckton Nebula W022 D3  
 Beckton Lana Y130 N < Beckton Lana W525 D  
 Beckton Emperor Z750 N3 < Beckton Emperor T641 E2  
 Beckton Minola B063 E < Beckton Lana U789 NB  
 Beckton Minola Z752 N < Beckton Nebula W130 D3  
 Beckton Minola N751 JL

BWt 64  
 WR 85  
 YWt. 907  
 YR 90  
 FebADG 3.33  
 Frame 4.5  
 Feet Good

**DAM**  
 Age 8  
 Wt 1110  
 Prog. BW 67  
 WR 102  
 YR 103  
 Udder NA  
 Wean Pct. 36%  
 Cow Eff. 75

Calv.Ease	BW	WW	YW	Milk	HPG	Stay	Maint.En.
EPDs 18	-6.0	42	74	28	13	16	1.0
Marb +.45		REA -.27				Bfat +.03	
Beef Tenderness →	DNA: 9 / Outstanding	Scan: 1.9 / Tender					
HerdBuilder Index: 59	Pct.: 43%	ProS: 95	Pct.: 46%				

★★★★★ for Marbling, Calving Ease.

**230****Beckton Likable K728 L4**

1-A 100% # 4675935 Tat: BKT2 K728



Birth: 4-19-22

Beckton Likable U130 L2 < Beckton Likable S633  
 Beckton Likable E636 C3 < Beckton Kit S478 LN  
 Ref. L-3 < BKT Clifftop TP R288  
 Beckton Minola W808 C < Beckton Minola R604 CD  
 Beckton Likable E391 N4 < Beckton Likable Y124 L3  
 Beckton Lakme G011 L < Beckton Lana X466 N  
 Beckton Lakme E370 L < Beckton Likable Y124 L3  
 Beckton Lakme Y027 A

BWt 64  
 WR 105  
 YWt. 949  
 YR 97  
 FebADG 3.39  
 Frame 5.0  
 Feet Good

**DAM**  
 Age 3  
 Wt 900  
 Prog. BW 64  
 WR 105  
 YR 97  
 Udder Very Good  
 Wean Pct. 47%  
 Cow Eff. 99

Calv.Ease	BW	WW	YW	Milk	HPG	Stay	Maint.En.
EPDs 16	-3.8	57	80	26	13	18	-1.0
Marb +.31		REA +.11				Bfat +.03	
Beef Tenderness →	DNA: 10 / Outstanding	Scan: 1.9 / Tender					
HerdBuilder Index: 76	Pct.: 13%	ProS: 82	Pct.: 67%				

★★★★★ for Low Maintenance, Marbling, Calving Ease.

**231****Beckton Accent K663 S4**

1-A 100% # 4675373 Tat: BKT2 K663



Birth: 4-13-22

Beckton Accent B553 L2 < Beckton Accent U777 C2  
 Beckton Accent F895 E3 < Beckton Lana X839 L  
 Ref. A < Beckton Epic K6 S569  
 Beckton Indigo U504 EP < Beckton Indigo S016 NB  
 Beckton Scamp A626 H3 < Beckton Scamp T A825  
 Beckton Susan C047 S < Beckton Rose T770 HI  
 Beckton Susan A112 S < Beckton Scamp X494 E3  
 Beckton Susan T199 CT

BWt 64  
 WR 91  
 YWt. 938  
 YR 93  
 FebADG 2.70  
 Frame 4.5  
 Feet Good

**DAM**  
 Age 7  
 Wt 1005  
 Prog. BW 63  
 WR 103  
 YR 102  
 Udder Very Good  
 Wean Pct. 43%  
 Cow Eff. 89

Calv.Ease	BW	WW	YW	Milk	HPG	Stay	Maint.En.
EPDs 17	-4.9	49	78	30	11	14	-4.0
Marb +.43		REA -.06				Bfat +.04	
Beef Tenderness →	DNA: 10 / Outstanding	Scan: 1.8 / Tender					
HerdBuilder Index: 53	Pct.: 55%	ProS: 79	Pct.: 72%				

★★★★★ for Low Maintenance, Marbling, Calving Ease.



Lot 231

\*Note: Scrotal and ultrasound data will be available later

## 232 Beckton New Era K644 L2

1-A 100% # 4675239 Tat: BKT2 K644



Birth: 4-11-22

Beckton New Era Y194  
 Ref. N-1

Beckton Christy A231 L

Beckton Nebula P P707  
 Beckton Nebula M045  
 Beckton Lana M809 EP

BKT Larkeisa T310 JC  
 Beckton Justice C1 R483  
 BKT Larkeisa R775 JC

Beckton Likable Y675 E3  
 Beckton Likable U120 L2  
 Beckton Firefly T331 EP

Beckton Nebula U206 V3  
 Beckton Christy S475 EP

BWt	73
WR	89
YWt.	898
YR	90
FebADG	3.08
Frame	5.0
Feet	Good

DAM	
Age	9
Wt	975
Prog. BW	65
WR	98
YR	93
Udder	Very Good
Wean Pct.	44%
Cow Eff.	93

Calv.Ease	BW	WW	YW	Milk	HPG	Stay	Maint.En.	
EPDs	15	-3.8	49	77	28	13	20	-5.0
Marb	+0.30		REA		-0.06	Bfat		+0.02
Beef Tenderness	→ DNA: 10 / Outstanding		Scan:		2.2 / Tender			
HerdBuilder Index:	72	Pct.: 19%	ProS:		93	Pct.: 50%		

★★★★★ for Low Maintenance, Marbling, Calving Ease.

## 235 Beckton Cardinal K753 E2

1-A 100% # 4676771 Tat: BSF2 K753



Birth: 4-21-22

Beckton Cardinal E673 L  
 Ref. C-1

Beckton Larkabel G636 E

TR Double Eagle ZT220  
 Beckton Lana U182 JC

Beckton Legend U331 E2  
 Beckton Larkaba T418 WA

Beckton Epic U749 D5  
 Beckton Indigo U504 EP

Beckton Epic U749 D5  
 Bkt Larkabel K768 EP

BWt	57
WR	103
YWt.	1014
YR	104
FebADG	3.40
Frame	5.0
Feet	Good

DAM	
Age	3
Wt	975
Prog. BW	49
WR	98
YR	98
Udder	Very Good
Wean Pct.	45%
Cow Eff.	96

Calv.Ease	BW	WW	YW	Milk	HPG	Stay	Maint.En.	
EPDs	21	-6.6	58	95	28	11	15	3.0
Marb	+0.47		REA		+0.20	Bfat		+0.05
Beef Tenderness	→ DNA: 9 / Outstanding		Scan:		1.7 / Tender			
HerdBuilder Index:	57	Pct.: 47%	ProS:		98	Pct.: 40%		

★★★★★ for Marbling, Rib-eye area, Calving Ease.

## 233 Beckton Likable K491 A6

1-A 100% # 4675953 Tat: BKT2 K491



Birth: 3-31-22

Beckton Likable G289 J5  
 Ref. L-5

Beckton Belga G094 A

Beckton Likable X445 J3  
 Beckton Minola X107 L

Beckton Julian GG B571  
 Beckton Coca X787 N

Beckton Accent A175 O3  
 Beckton Eola U027 NB

Beckton Warrior Y108 E5  
 Beckton Belga A160 A

BWt	60
WR	96
YWt.	955
YR	98
FebADG	2.86
Frame	5.0
Feet	Good

DAM	
Age	3
Wt	730
Prog. BW	58
WR	100
YR	99
Udder	Very Good
Wean Pct.	56%
Cow Eff.	119

Calv.Ease	BW	WW	YW	Milk	HPG	Stay	Maint.En.	
EPDs	17	-4.3	57	94	27	14	16	-2.0
Marb	+0.41		REA		-0.02	Bfat		+0.03
Beef Tenderness	→ DNA: 10 / Outstanding		Scan:		1.9 / Tender			
HerdBuilder Index:	60	Pct.: 40%	ProS:		99	Pct.: 40%		

★★★★★ for Low Maintenance, Marbling, Cow Efficiency, Calving Ease.



Lot 236

## 234 Beckton Accent K274 A6

1-A 100% # 4675997 Tat: BKT2 K274



Birth: 3-18-22

Beckton Accent H059 N5  
 Ref. A-7

Beckton Minola H815 A

Beckton Accent F363 L4  
 Beckton Coca B062 L

Beckton Nebula X603 J4  
 Beckton Encino A442 J

Beckton Accent Y312 N3  
 Beckton Minerva Y654 N

Beckton Epic B545 N7  
 Beckton Minola B538 E

BWt	57
WR	97
YWt.	929
YR	94
FebADG	3.27
Frame	5.0
Feet	Good

DAM	
Age	2
Wt	775
Prog. BW	57
WR	97
YR	94
Udder	Very Good
Wean Pct.	49%
Cow Eff.	103

Calv.Ease	BW	WW	YW	Milk	HPG	Stay	Maint.En.	
EPDs	17	-4.3	54	92	27	13	15	4.0
Marb	+0.45		REA		+0.07	Bfat		+0.04
Beef Tenderness	→ DNA: 9 / Outstanding		Scan:		1.5 / Tender +			
HerdBuilder Index:	52	Pct.: 58%	ProS:		88	Pct.: 57%		

★★★★★ for Marbling, Calving Ease.

## 236 Beckton Accent K419 E4

1-A 100% # 4675573 Tat: BKT2 K419



Birth: 3-28-22

Beckton Accent B740 W3  
 Ref. A-3

Beckton Firefly E679 E

Beckton Accent W180 C2  
 Beckton Christy R046 CQ

Beckton Warrior W534 N4  
 Beckton Lana W370 E

Beckton Emperor Y459 J3  
 Beckton Minola Y634 W

Beckton Accent W180 C2  
 Beckton Firefly X336 H

BWt	59
WR	99
YWt.	956
YR	96
FebADG	2.95
Frame	5.0
Feet	Good

DAM	
Age	5
Wt	1035
Prog. BW	58
WR	103
YR	99
Udder	Very Good
Wean Pct.	46%
Cow Eff.	98

Calv.Ease	BW	WW	YW	Milk	HPG	Stay	Maint.En.	
EPDs	20	-5.7	60	94	27	12	15	-1.0
Marb	+0.39		REA		+0.20	Bfat		+0.03
Beef Tenderness	→ DNA: 9 / Outstanding		Scan:		1.3 / Tender +			
HerdBuilder Index:	67	Pct.: 27%	ProS:		88	Pct.: 57%		

★★★★★ for Low Maintenance, Marbling, Rib-eye area, Calving Ease.

\*Note: Scrotal and ultrasound data will be available later

# 237

## WCRA Dominor K209

A 100% # 4659659 Tat: WCRA2K209



Birth: 4-3-22

Beckton Dominor D254 N8 < Beckton Dominor A378 W7  
 Beckton Indigo W772 N  
**Beckton Dominor H423 N9**  
 Ref. D-4 < Beckton Lana Y130 N < Beckton Nebula W022 D3  
 Beckton Lana W525 D  
 < Beckton Nebula P P707  
**WCRA Pine Marie E122 N**  
 < Carpenter Nebula B002 N < Beckton Rose Z266 E  
 < WCRA Pine Marir C 108 C < HXC Conquest 4405P  
 BKT Pine Marie Z513 W

BWt 68  
 WR 108  
 YWt. 851  
 YR 92  
 FebADG 2.38  
 Frame 5.0  
 Feet Good

DAM		Calv.Ease	BW	WW	YW	Milk	HPG	Stay	Maint.En.	
Age	5	EPDs	19	-7.0	47	71	32	12	17	-3.0
Wt	960	Marb	+4.5		REA	-0.6		Bfat	+0.4	
Prog. BW	62	Beef Tenderness →	DNA: NA / NA		Scan:	1.2 / Tender +				
WR	101	HerdBuilder Index:	73	Pct.: 71%	ProS:	91	Pct.: 52%			
YR	97	★★★★★ for Low Maintenance, Marbling, Calving Ease.								
Udder	Very Good									
Wean Pct.	56%									
Cow Eff.	NA									



Lot 237

# 238

## Beckton Nebula K327 E5

1-A 100% # 4675243 Tat: BKT2 K327



Birth: 3-22-22

Beckton Nebula B557 J3 < Beckton Nebula P P707  
 Beckton Larkaba T813 JC  
**Beckton Nebula G249 N4**  
 Ref. N-4 < Beckton Lana Y130 N < Beckton Nebula W022 D3  
 Beckton Lana W525 D  
 < Beckton Epic X464 L5 < Beckton Epic K6 S569  
**Beckton Indigo B204 E**  
 < Beckton Indigo P043 L0 < Beckton Loki C M740  
 Beckton Indigo M571 EP

BWt 57  
 WR 110  
 YWt. 872  
 YR 88  
 FebADG 1.46  
 Frame 5.0  
 Feet Good

DAM		Calv.Ease	BW	WW	YW	Milk	HPG	Stay	Maint.En.	
Age	8	EPDs	16	-4.6	53	84	31	13	16	10.0
Wt	1150	Marb	+4.0		REA	-0.6		Bfat	+0.3	
Prog. BW	74	Beef Tenderness →	DNA: 9 / Outstanding		Scan:	1.4 / Tender +				
WR	113	HerdBuilder Index:	57	Pct.: 47%	ProS:	79	Pct.: 72%			
YR	107	★★★★★ for Marbling, Superior Cow, Calving Ease.								
Udder	Very Good									
Wean Pct.	46%									
Cow Eff.	97									

# 239

## Beckton Warrior K486 W8

1-A 100% # 4675577 Tat: BKT2 K486



Birth: 3-31-22

Beckton Warrior D359 L6 < Beckton Warrior Y108 E5  
 Beckton Lana W463 L  
**Beckton Warrior G356 N7**  
 Ref. W-1 < Beckton Larkaba B277 N < Beckton New Era Y194  
 Beckton Larkaba U062 CB  
 < Beckton Warrior Y108 E5 < Beckton Susan W058 E  
**Beckton Lana E278 W**  
 < Beckton Ranger Z225 J4  
 Beckton Lana B028 R < Beckton Lana Z730 J

BWt 60  
 WR 102  
 YWt. 827  
 YR 83  
 FebADG NA  
 Frame 4.5  
 Feet Good

DAM		Calv.Ease	BW	WW	YW	Milk	HPG	Stay	Maint.En.	
Age	5	EPDs	20	-6.8	38	53	31	12	14	-3.0
Wt	NA	Marb	+3.6		REA	-3.9		Bfat	+0.3	
Prog. BW	60	Beef Tenderness →	DNA: 10 / Outstanding		Scan:	1.7 / Tender				
WR	103	HerdBuilder Index:	55	Pct.: 51%	ProS:	44	Pct.: 98%			
YR	100	★★★★★ for Low Maintenance, Marbling, Calving Ease.								
Udder	Very Good									
Wean Pct.	NA%									
Cow Eff.	NA									

# 240

## Beckton Likable K244 N7

1-A 100% # 4675133 Tat: BKT2 K244



Birth: 3-17-22

Beckton Likable B032 C5 < Beckton Likable Z057 L4  
 Beckton Mona Z270 C  
**Beckton Likable F287 J6**  
 Ref. L-4 < Beckton Larkaba X064 J < Beckton Julian U699 L5  
 Beckton Larkaba U475 CT  
 < Beckton Nebula U206 V3 < Beckton Nebula P P707  
**Beckton Minerva X047 N**  
 < Beckton Minerva U205 NB < Beckton Minerva J615 VG  
 Beckton Minerva F495 CH

BWt 67  
 WR 108  
 YWt. 897  
 YR 89  
 FebADG 1.30  
 Frame 4.5  
 Feet Good

DAM		Calv.Ease	BW	WW	YW	Milk	HPG	Stay	Maint.En.	
Age	12	EPDs	16	-4.6	55	88	27	13	18	2.0
Wt	1170	Marb	+4.6		REA	-2.5		Bfat	+0.4	
Prog. BW	68	Beef Tenderness →	DNA: 9 / Outstanding		Scan:	1.6 / Tender +				
WR	109	HerdBuilder Index:	73	Pct.: 17%	ProS:	90	Pct.: 54%			
YR	104	★★★★★ for Marbling, Superior Cow, Calving Ease.								
Udder	Very Good									
Wean Pct.	42%									
Cow Eff.	88									



Lot 238

\*Note: Scrotal and ultrasound data will be available later

# The Yearling Heifers



Beckton females are nearly ideal for today's industry – moderately sized, efficient producers. They combine calving ease, growth, and desirable carcass traits. They are feminine, maternal and quiet, with nice udders and sound feet. All of our heifer calves trailed up with their mothers into the Bighorn Mountains to spend their first summer. They have learned the meaning of mothering ability. And they have the productive

capacity to produce the bulls that you see in our sale. The sale heifers are a select group from the top of our replacements.

If you wish, we can also keep any sale heifers through the summer and breed them in natural service to the same herd sires we use with our own replacements. There will be a charge of \$250 per heifer plus delivery at cost in the fall. Visit with Cam about this program.



Beckton is offering two straws of P707 semen or any other sire (for which we have adequate supply) to go with every heifer purchased. The buyer will only be responsible for shipping from Billings, MT and semen may be used on any animal the buyer would like.

## 301 Beckton Suffeina K158 S

1-A 100% # 4675235 Tattoo: BKT2 K158

Birth: 3-7-22

Beckton Scamp G236 L6  
 Ref. S-3

Beckton Suffeina A190 A

**DAM**

Age	9
Wt	1280
Prog. BW	79
WR	114
YR	114
Udder	Very Good

Calv.Ease	BW	WW	YW	Milk	HPG	Stay	Maint.En.	
EPDs	11	-1.1	65	106	30	12	18	3.0
Marb	+0.40		REA	-0.02		Bfat		+0.03
Sire Tenderness: 10 / Outstanding								
Cow Eff.	89	CEM	4	HB		35%		

★★★★★ for Growth, Marbling, Superior Cow, Stayability.

## 304 Beckton Indigo K535 H

1-A 100% # 4676527 Tattoo: BKB2 K535

Birth: 4-3-22

Beckton Hughes F076 H3  
 Ref. B-1

Beckton Indigo D465 A

**DAM**

Age	6
Wt	920
Prog. BW	76
WR	120
YR	121
Udder	Good

Calv.Ease	BW	WW	YW	Milk	HPG	Stay	Maint.En.	
EPDs	16	-2.6	58	96	31	13	17	2.0
Marb	+0.33		REA	-0.07		Bfat		+0.04
Sire Tenderness: 9 / Outstanding								
Cow Eff.	129	CEM	8	HB		16%		

★★★★★ for Growth, Marbling, Superior Cow, High Cow Efficiency, Calving Ease, Stayability.

## 302 Beckton Lydia K326 S

1-A 100% # 4675387 Tattoo: BKT2 K326

Birth: 3-22-22

Beckton Scamp G325 N6  
 Ref. S

Beckton Lydia D366 A

**DAM**

Age	6
Wt	1130
Prog. BW	75
WR	111
YR	111
Udder	Very Good

Calv.Ease	BW	WW	YW	Milk	HPG	Stay	Maint.En.	
EPDs	9	0.5	60	99	30	12	17	-1.0
Marb	+0.41		REA	-0.03		Bfat		+0.03
Sire Tenderness: 10 / Outstanding								
Cow Eff.	88	CEM	2	HB		51%		

★★★★★ for Low Maintenance, Growth, Marbling, Superior Cow, Stayability.



## 303 Beckton Pine Marie K222 L

1-A 100% # 4675461 Tattoo: BKT2 K222

Birth: 3-15-22

Beckton Likable F287 J6  
 Ref. L-4

Beckton Pine Marie D563 E

**DAM**

Age	6
Wt	1180
Prog. BW	57
WR	105
YR	101
Udder	Very Good

Calv.Ease	BW	WW	YW	Milk	HPG	Stay	Maint.En.	
EPDs	16	-4.9	63	105	26	12	15	5.0
Marb	+0.47		REA	+0.00		Bfat		+0.05
Sire Tenderness: 9 / Outstanding								
Cow Eff.	98	CEM	7	HB		61%		

★★★★★ for Growth, Marbling, Calving Ease, Stayability.

## 305 Beckton Minola K380 N

1-A 100% # 4676571 Tattoo: BSF2 K380

Birth: 3-26-22

Beckton Nebula F440 H4  
 Ref. N-3

Beckton Minola E209 S

**DAM**

Age	5
Wt	1105
Prog. BW	69
WR	110
YR	106
Udder	Very Good

Calv.Ease	BW	WW	YW	Milk	HPG	Stay	Maint.En.	
EPDs	15	-2.4	59	99	26	9	13	2.0
Marb	+0.42		REA	+0.02		Bfat		+0.02
Sire Tenderness: 9 / Outstanding								
Cow Eff.	99	CEM	6	HB		84%		

★★★★★ for Marbling, Superior Cow, Calving Ease, Stayability.



## 306 Beckton Minola K347 A

1-A 100% # 4676749 Tattoo: BKT2 K347

Birth: 3-23-22

Beckton Accent B549 N3  
 Ref. A-2

Beckton Minola F010 N

Beckton Accent W180 C2  
 Beckton Minerva Y654 N  
 Beckton New Era D478 C2  
 Beckton Minola D350 A

Beckton Cody K1 P014  
 Beckton Christy R046 CQ  
 Beckton Nebula T398 V3  
 Beckton Minerva M369 L0  
 Beckton New Era Y194  
 Beckton Coca X734 C  
 Beckton Accent U777 C2  
 Beckton Minola S464 EP

BWt	78
WR	111
YR	114
Fr.	Med

DAM	
Age	4
Wt	1040
Prog. BW	70
WR	112
YR	106
Udder	Very Good

Calv.Ease	BW	WW	YW	Milk	HPG	Stay	Maint.En.	
EPDs	11	-1.5	69	114	26	11	17	8.0
Marb	+0.47		REA	+0.05		Bfat		+0.03
Sire Tenderness: 9 / Outstanding								
Cow Eff.	104	CEM	4	HB	56%			

★★★★★ for Growth, Marbling, Superior Cow, Stayability.

## 308 Beckton Minola K211 L

1-A 100% # 4675845 Tattoo: BKT2 K211

Birth: 3-13-22

Beckton Likable F287 J6  
 Ref. L-4

Beckton Minola G141 N

Beckton Likable B032 C5  
 Beckton Larkaba X064 J  
 Beckton Nebula B557 J3  
 Beckton Minola B160 N

Beckton Likable Z057 L4  
 Beckton Mona Z270 C  
 Beckton Julian U699 L5  
 Beckton Larkaba U475 CT  
 Beckton Nebula P P707  
 Beckton Larkaba T813 JC  
 Beckton New Era Y194  
 Beckton Minola U839 CT

BWt	65
WR	115
YR	114
Fr.	Med

DAM	
Age	3
Wt	1120
Prog. BW	56
WR	96
YR	114
Udder	Very Good

Calv.Ease	BW	WW	YW	Milk	HPG	Stay	Maint.En.	
EPDs	16	-4.5	65	112	21	13	17	7.0
Marb	+0.52		REA	-0.03		Bfat		+0.05
Sire Tenderness: 9 / Outstanding								
Cow Eff.	93	CEM	6	HB	41%			

★★★★★ for Growth, Marbling, Calving Ease, Stayability.

## 307 Beckton Minerva K342 S

1-A 100% # 4675397 Tattoo: BKT2 K342

Birth: 3-23-22

Beckton Scamp E175 N5  
 Ref. S-1

Beckton Minerva D506 D

Beckton Scamp B720 L4  
 Beckton Belga W103 N  
 Beckton Dominor A378 W7  
 Beckton Minerva A885 E

Beckton Scamp X458 H3  
 Beckton Larkaba Y448 L  
 Beckton Nebula T398 V3  
 Beckton Belga T551 EP  
 Beckton Dominor Y005 V6  
 Beckton Lana Y541 W  
 Beckton Epic Y484 N6  
 Beckton Minerva Y324 N

BWt	77
WR	101
YR	108
Fr.	Med

DAM	
Age	6
Wt	1070
Prog. BW	69
WR	103
YR	105
Udder	Very Good

Calv.Ease	BW	WW	YW	Milk	HPG	Stay	Maint.En.	
EPDs	17	-3.4	54	97	30	11	16	5.0
Marb	+0.43		REA	+0.10		Bfat		+0.03
Sire Tenderness: 9 / Outstanding								
Cow Eff.	99	CEM	8	HB	54%			

★★★★★ for Growth, Marbling, Superior Cow, Calving Ease, Stayability.

## 309 Beckton Coca K332 S

1-A 100% # 4676699 Tattoo: BSF2 K332

Birth: 3-22-22

Beckton Scamp E175 N5  
 Ref. S-1

Beckton Coca F310 E

Beckton Scamp B720 L4  
 Beckton Belga W103 N  
 Beckton Epic Z674 E6  
 Beckton Coca C518 L

Beckton Scamp X458 H3  
 Beckton Larkaba Y448 L  
 Beckton Nebula T398 V3  
 Beckton Belga T551 EP  
 Beckton Epic U749 D5  
 Beckton Indigo U504 EP  
 Beckton Legend S670  
 Beckton Coca X734 C

BWt	52
WR	84
YR	115
Fr.	Med

DAM	
Age	4
Wt	1005
Prog. BW	59
WR	105
YR	112
Udder	Very Good

Calv.Ease	BW	WW	YW	Milk	HPG	Stay	Maint.En.	
EPDs	19	-6.6	44	78	29	10	17	2.0
Marb	+0.44		REA	-0.05		Bfat		+0.04
Sire Tenderness: 9 / Outstanding								
Cow Eff.	84	CEM	7	HB	70%			

★★★★★ for Growth, Marbling, Superior Cow, Calving Ease, Stayability.



Cody Cunningham (brand inspector), Sarah Schreiber (veterinarian), and Janet Drake (health permit expert)

## 310 Beckton Jane K282 L

1-A 100% # 4676491 Tattoo: BSF2 K282

Birth: 3-19-22

Beckton Likable F287 J6  
 Ref. L-4

Beckton Jane C065 E

Beckton Likable B032 C5  
 Beckton Larkaba X064 J  
 Beckton Epic A286 E7  
 Beckton Jane A724 E

Beckton Likable Z057 L4  
 Beckton Mona Z270 C  
 Beckton Julian U699 L5  
 Beckton Larkaba U475 CT  
 Beckton Epic Y484 N6  
 Beckton Larkaba Y648 E  
 Beckton Epic U749 D5  
 Beckton Jane X164 N

BWt	69
WR	106
YR	102
Fr.	Sml

DAM	
Age	7
Wt	1230
Prog. BW	67
WR	116
YR	112
Udder	Fair

Calv.Ease	BW	WW	YW	Milk	HPG	Stay	Maint.En.	
EPDs	15	-3.7	60	105	29	12	13	7.0
Marb	+0.47		REA	-0.03		Bfat		+0.06
Sire Tenderness: 9 / Outstanding								
Cow Eff.	90	CEM	6	HB	91%			

★★★★★ for Marbling, Superior Cow, Calving Ease, Stayability.

# 311

## Beckton Minola K425 L

1-A 100% # 4675813 Tattoo: BKT2 K425

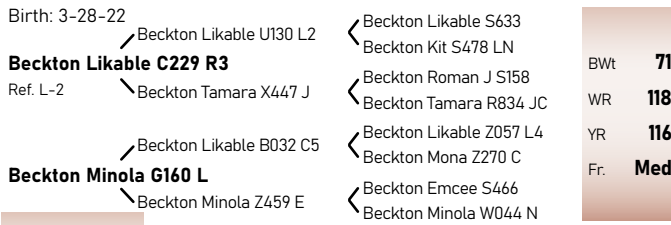

BWt **71**  
WR **118**  
YR **116**  
Fr. **Med**

DAM		Calv.Ease	BW	WW	YW	Milk	HPG	Stay	Maint.En.	
Age	3	EPDs	13	-1.6	70	115	28	11	15	7.0
Wt	1010	Marb	+0.41		REA	+0.23		Bfat +0.03		
Prog. BW	61	Sire Tenderness: 9 / Outstanding								
WR	118	Cow Eff.	106		CEM	5		HB 77%		
YR	116									
Udder	Very Good									

★★★★★ for Growth, Marbling, Rib-eye area, Superior Cow, Calving Ease, Stayability.

# 314

## Beckton Tamara K433 S

1-A 100% # 4675635 Tattoo: BKT2 K433

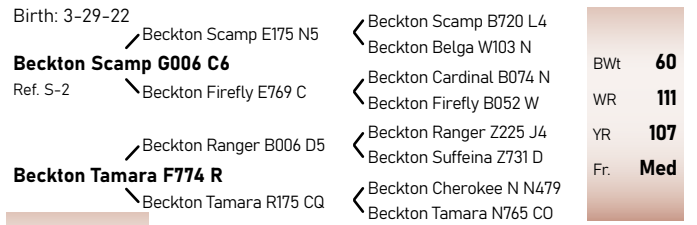

BWt **60**  
WR **111**  
YR **107**  
Fr. **Med**

DAM		Calv.Ease	BW	WW	YW	Milk	HPG	Stay	Maint.En.	
Age	4	EPDs	19	-6.1	56	96	32	10	16	7.0
Wt	1010	Marb	+0.47		REA	-0.01		Bfat +0.05		
Prog. BW	60	Sire Tenderness: 9 / Outstanding								
WR	110	Cow Eff.	107		CEM	9		HB 51%		
YR	106									
Udder	Very Good									

★★★★★ for Growth, Marbling, Superior Cow, Calving Ease, Stayability.

# 312

## Beckton Sierra K484 L

1-A 100% # 4675931 Tattoo: BKT2 K484

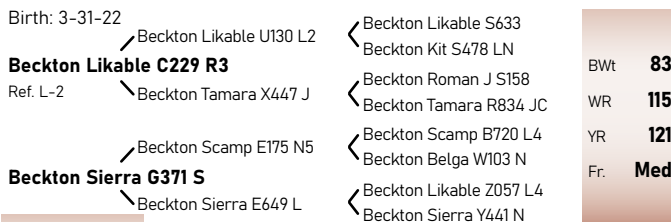

BWt **83**  
WR **115**  
YR **121**  
Fr. **Med**

DAM		Calv.Ease	BW	WW	YW	Milk	HPG	Stay	Maint.En.	
Age	3	EPDs	10	0.2	70	114	27	11	15	4.0
Wt	910	Marb	+0.41		REA	+0.18		Bfat +0.03		
Prog. BW	77	Sire Tenderness: 9 / Outstanding								
WR	115	Cow Eff.	114		CEM	3		HB 77%		
YR	121									
Udder	Very Good									

★★★★★ for Growth, Marbling, Rib-eye area, Superior Cow, Stayability.

# 315

## Beckton Lana K507 L

1-A 100% # 4675403 Tattoo: BKT2 K507

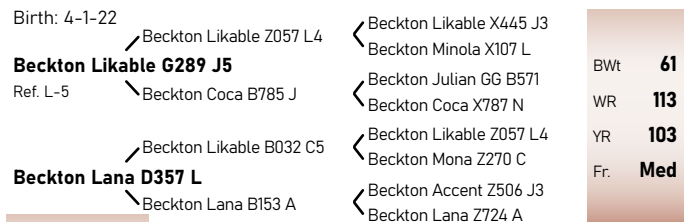

BWt **61**  
WR **113**  
YR **103**  
Fr. **Med**

DAM		Calv.Ease	BW	WW	YW	Milk	HPG	Stay	Maint.En.	
Age	6	EPDs	16	-4.7	59	103	28	14	16	8.0
Wt	1180	Marb	+0.49		REA	+0.04		Bfat +0.04		
Prog. BW	64	Sire Tenderness: 10 / Outstanding								
WR	109	Cow Eff.	100		CEM	5		HB 70%		
YR	109									
Udder	Good									

★★★★★ for Marbling, Superior Cow, Calving Ease, Stayability.

# 313

## Beckton Emera K722 L

1-A 100% # 4676731 Tattoo: BKT2 K722

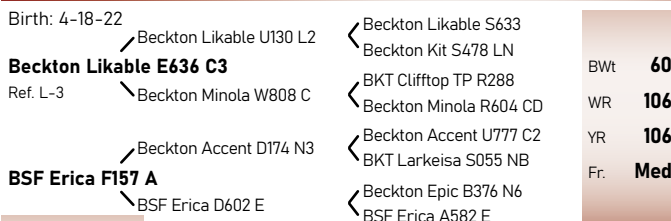

BWt **60**  
WR **106**  
YR **106**  
Fr. **Med**

DAM		Calv.Ease	BW	WW	YW	Milk	HPG	Stay	Maint.En.	
Age	6	EPDs	16	-5.3	55	85	29	14	14	-2.0
Wt	1090	Marb	+0.36		REA	+0.20		Bfat +0.04		
Prog. BW	58	Sire Tenderness: NA / NA								
WR	115	Cow Eff.	102		CEM	6		HB 71%		
YR	109									
Udder	NA									

★★★★★ for Low Maintenance, Growth, Marbling, Rib-eye area, Superior Cow, Calving Ease, Stayability.

# 316

## Beckton Larkaba K559 A

1-A 100% # 4675201 Tattoo: BKT2 K559

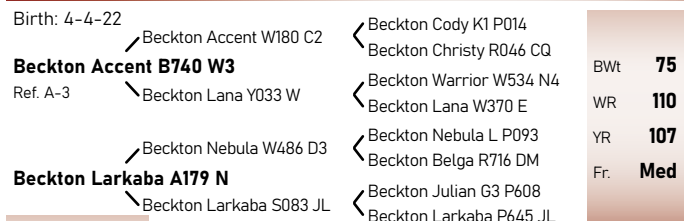

BWt **75**  
WR **110**  
YR **107**  
Fr. **Med**

DAM		Calv.Ease	BW	WW	YW	Milk	HPG	Stay	Maint.En.	
Age	9	EPDs	16	-3.4	63	101	25	13	15	-1.0
Wt	1130	Marb	+0.46		REA	+0.16		Bfat +0.03		
Prog. BW	69	Sire Tenderness: 9 / Outstanding								
WR	105	Cow Eff.	102		CEM	6		HB 64%		
YR	103									
Udder	Very Good									

★★★★★ for Low Maintenance, Growth, Marbling, Rib-eye area, Superior Cow, Calving Ease, Stayability.

## 317 BSF Julianne K554 L

1-B 99% # 4676609 Tattoo: BSF2 K554

Birth: 4-4-22

Beckton Likable F520 N5  
 Ref. L

Beckton Likable Z057 L4  
 Beckton Sierra A836 N

Beckton Jet L P491  
 BSF Julianne E555 J

Beckton Likable X445 J3  
 Beckton Minola X107 L  
 Beckton New Era Y194  
 Beckton Sierra S847 WR  
 TR Julian Lt151  
 Beckton Minerva L278 LN  
 Beckton Nebula W486 D3  
 BSF Julianne U532 WR

BWt	85
WR	125
YR	124
Fr.	Med

DAM	
Age	5
Wt	1065
Prog. BW	74
WR	112
YR	109
Udder	Very Good

Calv.Ease	BW	WW	YW	Milk	HPG	Stay	Maint.En.	
EPDs	8	0.4	75	121	25	13	16	8.0
Marb	+0.46		REA	+0.10		Bfat	+0.03	
Sire Tenderness: 9 / Outstanding								
Cow Eff.	123	CEM	2	HB	79%			

★★★★★ for Growth, Marbling, Superior Cow, High Cow Efficiency, Stayability.

## 320 BSF Helena K357 S

1-B 99% # 4677037 Tattoo: BKB2 K357

Birth: 3-24-22

Beckton Scamp E175 N5  
 Ref. S-1

Beckton Scamp B720 L4  
 Beckton Belga W103 N

Beckton New Era A409 N2  
 BSF Helena C408 N

Beckton Scamp X458 H3  
 Beckton Larkaba Y448 L  
 Beckton Nebula T398 V3  
 Beckton Belga T551 EP  
 Beckton New Era Y194  
 Beckton Eola W796 N  
 Beckton Scamp X458 H3  
 BSF Helena W042 W

BWt	82
WR	101
YR	101
Fr.	Med

DAM	
Age	7
Wt	1280
Prog. BW	81
WR	108
YR	110
Udder	Fair

Calv.Ease	BW	WW	YW	Milk	HPG	Stay	Maint.En.	
EPDs	14	-1.8	60	105	29	10	15	6.0
Marb	+0.38		REA	+0.01		Bfat	+0.02	
Sire Tenderness: 9 / Outstanding								
Cow Eff.	83	CEM	6	HB	80%			

★★★★★ for Marbling, Superior Cow, Calving Ease, Stayability.

## 318 BSF Nebulann K226 S

1-B 99% # 4676365 Tattoo: BSF2 K226

Birth: 3-15-22

Beckton Scamp E175 N5  
 Ref. S-1

Beckton Scamp B720 L4  
 Beckton Belga W103 N

Beckton Loki X833 H4  
 BSF Nebulann Z012 L

Beckton Scamp X458 H3  
 Beckton Larkaba Y448 L  
 Beckton Nebula T398 V3  
 Beckton Belga T551 EP  
 Beckton Loki CL S284  
 Beckton Vernice T447 HT  
 Beckton Nebula T269 E2  
 BSF Red G449

BWt	75
WR	110
YR	108
Fr.	Med

DAM	
Age	10
Wt	1190
Prog. BW	73
WR	108
YR	107
Udder	Very Good

Calv.Ease	BW	WW	YW	Milk	HPG	Stay	Maint.En.	
EPDs	14	-2.9	58	100	30	8	14	8.0
Marb	+0.41		REA	-0.06		Bfat	+0.03	
Sire Tenderness: 9 / Outstanding								
Cow Eff.	97	CEM	6	HB	91%			

★★★★★ for Growth, Marbling, Superior Cow, Calving Ease, Stayability.

## 321 Beckton Pine Marie K195 D

1-A 100% # 4675579 Tattoo: BKT2 K195

Birth: 3-11-22

Beckton Dominor D254 N8  
 Ref. D

Beckton Dominor A378 W7  
 Beckton Indigo W772 N

Beckton Dominor C052 E8  
 Beckton Pine Marie E185 D

Beckton Dominor Y005 V6  
 Beckton Lana Y541 W  
 Beckton Nebula T398 V3  
 Beckton Indigo T613 JT  
 Beckton Dominor A378 W7  
 Beckton Scarlett A406 E  
 Beckton Janus X799 L2  
 BKT Pine Marie X339 N

BWt	74
WR	104
YR	100
Fr.	Med

DAM	
Age	5
Wt	945
Prog. BW	70
WR	111
YR	101
Udder	Very Good

Calv.Ease	BW	WW	YW	Milk	HPG	Stay	Maint.En.	
EPDs	18	-3.2	49	84	36	13	14	4.0
Marb	+0.44		REA	+0.13		Bfat	+0.03	
Sire Tenderness: 10 / Outstanding								
Cow Eff.	107	CEM	9	HB	68%			

★★★★★ for Marbling, Rib-eye area, Calving Ease, Stayability.

## 319 BSF Codette K234 N

1-B 99% # 4676461 Tattoo: BSF2 K234

Birth: 3-15-22

Beckton Nebula F440 H4  
 Ref. N-3

Beckton Nebula B557 J3  
 Beckton Minola X638 H

Beckton Nebula X096 N4  
 BSF Codette C556 N

Beckton Nebula P P707  
 Beckton Larkaba T813 JC  
 Beckton Hasten H S462  
 Beckton Minola N751 JL  
 Beckton Nebula U206 V3  
 Beckton Tamara U185 NB  
 Beckton Nebula X353 E3  
 BSF Codette X384 E

BWt	65
WR	114
YR	104
Fr.	Med

DAM	
Age	7
Wt	1240
Prog. BW	59
WR	99
YR	96
Udder	Very Good

Calv.Ease	BW	WW	YW	Milk	HPG	Stay	Maint.En.	
EPDs	15	-4.1	63	99	28	11	18	3.0
Marb	+0.49		REA	-0.11		Bfat	+0.03	
Sire Tenderness: 9 / Outstanding								
Cow Eff.	97	CEM	6	HB	28%			

★★★★★ for Marbling, Calving Ease, Stayability.

## 322 Beckton Lydia K655 J

1-A 100% # 4675663 Tattoo: BKT2 K655

Birth: 4-12-22

Beckton Julian F067 L7  
 Ref. J-4

Beckton Julian D551 C6  
 Beckton Indigo D786 L

Beckton Likable D063 N4  
 Beckton Lydia F528 L

Beckton Julian X465 J5  
 Beckton Tamara W550 A  
 Beckton Likable Z057 L4  
 Beckton Indigo Y026 N  
 Beckton Likable Y124 L3  
 Beckton Serena W738 N  
 Beckton Accent Y260 L3  
 Beckton Lydia A246 L

BWt	75
WR	109
YR	106
Fr.	Med

DAM	
Age	4
Wt	1010
Prog. BW	64
WR	103
YR	106
Udder	Very Good

Calv.Ease	BW	WW	YW	Milk	HPG	Stay	Maint.En.	
EPDs	14	-2.3	63	113	26	13	15	14.0
Marb	+0.58		REA	+0.08		Bfat	+0.03	
Sire Tenderness: 9 / Outstanding								
Cow Eff.	109	CEM	5	HB	89%			

★★★★★ for Growth, Marbling, Calving Ease, Stayability.



Full house

### 325 Beckton Larkaba K635 S

1-A 100% # 4676591 Tattoo: BSF2 K635

Birth: 4-10-22

Beckton Scamp G236 L6  
Ref. S-3

Beckton Larkaba E728 A

Beckton Scamp D325 N5  
Beckton Indigo Y406 L  
Beckton Accent B653 C3  
Beckton Larkaba Z603 E

Beckton Scamp A627 J4  
Beckton Tamara Y039 N  
Beckton Likable U130 L2  
Beckton Indigo R745 WR  
Beckton Accent U777 C2  
Beckton Christy W779 C  
Beckton Emcee W526 J2  
Beckton Larkaba U274 JL

BWt	63
WR	101
YR	99
Fr.	Med

DAM		Calv.Ease	BW	WW	YW	Milk	HPG	Stay	Maint.En.	
Age	5	EPDs	17	-5.9	50	81	32	10	15	-5.0
Wt	1130	Marb	+5.2		REA	-0.7		Bfat	+0.2	
Prog. BW	59	Sire Tenderness: 10 / Outstanding								
WR	108	Cow Eff.	94		CEM	7		HB	47%	
YR	103									
Udder	NA									

★★★★★ for Low Maintenance, Marbling, Calving Ease, Stayability.

### 323 Beckton Suffeina K596 N

1-A 100% # 4675383 Tattoo: BKT2 K596

Birth: 4-7-22

Beckton Nebula F440 H4  
Ref. N-3

Beckton Suffeina D287 A

Beckton Nebula B557 J3  
Beckton Larkaba T813 JC  
Beckton Hasten H S462  
Beckton Minola N751 JL  
Beckton Cody K1 P014  
Beckton Susan R022 CQ  
Beckton Accent U777 C2  
Beckton Susan Y260 L3  
Beckton Suffeina A190 A  
Beckton Suffeina Y242 N

BWt	81
WR	112
YR	114
Fr.	Med

DAM		Calv.Ease	BW	WW	YW	Milk	HPG	Stay	Maint.En.	
Age	6	EPDs	11	-0.5	69	110	27	13	19	7.0
Wt	1170	Marb	+4.6		REA	-1.0		Bfat	+0.4	
Prog. BW	74	Sire Tenderness: 9 / Outstanding								
WR	103	Cow Eff.	93		CEM	3		HB	43%	
YR	105									
Udder	Good									

★★★★★ for Growth, Marbling, Stayability.

### 326 Beckton Sierra K675 S

1-A 100% # 4675605 Tattoo: BKT2 K675

Birth: 4-14-22

Beckton Scamp E175 N5  
Ref. S-1

Beckton Sierra E048 C

Beckton Scamp B720 L4  
Beckton Larkaba Y448 L  
Beckton Nebula T398 V3  
Beckton Belga W103 N  
Beckton Cliffot C201 A5  
Beckton Minola X198 A  
Beckton Sierra C324 L  
Mushrush Lunesta A007  
Beckton Sierra A245 L

BWt	69
WR	106
YR	108
Fr.	Sml

DAM		Calv.Ease	BW	WW	YW	Milk	HPG	Stay	Maint.En.	
Age	5	EPDs	16	-4.7	50	88	32	7	18	4.0
Wt	1000	Marb	+4.0		REA	-1.3		Bfat	+0.4	
Prog. BW	68	Sire Tenderness: 9 / Outstanding								
WR	108	Cow Eff.	107		CEM	7		HB	54%	
YR	105									
Udder	Very Good									

★★★★★ for Growth, Marbling, Superior Cow, Calving Ease, Stayability.

### 324 Beckton Coca K494 W

1-A 100% # 4675567 Tattoo: BKT2 K494

Birth: 3-31-22

Beckton Warrior G356 N7  
Ref. W-1

Beckton Coca E605 E

Beckton Warrior D359 L6  
Beckton Larkaba B277 N  
Beckton Epic Z674 E6  
Beckton Coca B550 W

Beckton Warrior Y108 E5  
Beckton Lana W463 L  
Beckton New Era Y194  
Beckton Larkaba U062 CB  
Beckton Epic U749 D5  
Beckton Indigo U504 EP  
Beckton Warrior W534 N4  
Beckton Coca T419 NB

BWt	76
WR	99
YR	101
Fr.	Med

DAM		Calv.Ease	BW	WW	YW	Milk	HPG	Stay	Maint.En.	
Age	5	EPDs	14	-3.1	56	90	30	11	14	-1.0
Wt	985	Marb	+4.0		REA	-1.6		Bfat	+0.4	
Prog. BW	66	Sire Tenderness: 10 / Outstanding								
WR	107	Cow Eff.	102		CEM	5		HB	80%	
YR	104									
Udder	Very Good									

★★★★★ for Low Maintenance, Marbling, Superior Cow, Calving Ease, Stayability.

### 327 Beckton Belga K228 D

1-A 100% # 4675795 Tattoo: BKT2 K228

Birth: 3-15-22

Beckton Dominor F263 N8  
Ref. D-1

Beckton Belga G135 L

Beckton Dominor A378 W7  
Beckton Larkaba W272 N  
Beckton Likable Z057 L4  
Beckton Belga Y254 N

Beckton Dominor Y005 V6  
Beckton Lana Y541 W  
Beckton Nebula EN S347  
Beckton Larkaba N643 HR  
Beckton Likable X445 J3  
Beckton Minola X107 L  
Beckton Nebula P P707  
Beckton Belga S747 EP

BWt	58
WR	102
YR	106
Fr.	Sml

DAM		Calv.Ease	BW	WW	YW	Milk	HPG	Stay	Maint.En.	
Age	3	EPDs	18	-5.1	52	89	29	14	14	0.0
Wt	995	Marb	+5.1		REA	-0.1		Bfat	+0.4	
Prog. BW	58	Sire Tenderness: 10 / Outstanding								
WR	96	Cow Eff.	92		CEM	8		HB	51%	
YR	100									
Udder	Very Good									

★★★★★ for Low Maintenance, Growth, Marbling, Calving Ease, Stayability.

## 328 Beckton Susan K026 E

1-A 100% # 4676039 Tattoo: BKT2 K026

Birth: 2-16-22

Beckton Epic H335 A8  
 Ref. E-3

Beckton Susan H682 D

Beckton Epic D001 L7  
 Beckton Coca D239 A

Beckton Epic B483 N6  
 Beckton Mona B713 L

Beckton Accent W180 C2  
 Beckton Coca T454 NX

Beckton Dominor E693 D9  
 Beckton Susan W058 E

Beckton Dominor C052 E8  
 Beckton Christy C149 D

Beckton Epic T330 L5  
 Beckton Susan T048 NB

BWt **47**  
 WR **110**  
 YR **102**  
 Fr. **Med**

DAM		Calv.Ease	BW	WW	YW	Milk	HPG	Stay	Maint.En.	
Age	2	EPDs	<b>19</b>	<b>-5.6</b>	<b>59</b>	<b>104</b>	<b>35</b>	<b>NA</b>	<b>16</b>	<b>9.0</b>
Wt	<b>865</b>	Marb	<b>+4.5</b>		REA	<b>+13</b>		Bfat <b>+0.5</b>		
Prog. BW	<b>47</b>	Sire Tenderness: <b>9 / Outstanding</b>								
WR	<b>110</b>	Cow Eff.	<b>103</b>		CEM	<b>9</b>		HB <b>52%</b>		
YR	<b>102</b>									
Udder	<b>Very Good</b>									



★★★★★ for Marbling, Rib-eye area, Calving Ease, Stayability.

## 329 Beckton Indigo K413 E

1-A 100% # 4675589 Tattoo: BKT2 K413

Birth: 3-27-22

Beckton Epic B545 N7  
 Ref. E

Beckton Indigo E705 A

Beckton Epic Y484 N6  
 Beckton Serena X338 N

Beckton Epic U749 D5  
 Beckton Lydia S069 NB

Beckton Nebula T398 V3  
 Beckton Serena S649 L0

Beckton Accent C557 N4  
 Beckton Indigo C261 E

Beckton Accent Y312 N3  
 Beckton Minerva Y654 N

Beckton Epic Y484 N6  
 Beckton Indigo U504 EP

BWt **60**  
 WR **99**  
 YR **102**  
 Fr. **Med**

DAM		Calv.Ease	BW	WW	YW	Milk	HPG	Stay	Maint.En.	
Age	5	EPDs	<b>14</b>	<b>-3.2</b>	<b>60</b>	<b>100</b>	<b>28</b>	<b>11</b>	<b>13</b>	<b>8.0</b>
Wt	<b>1015</b>	Marb	<b>+4.7</b>		REA	<b>+18</b>		Bfat <b>+0.5</b>		
Prog. BW	<b>63</b>	Sire Tenderness: <b>10 / Outstanding</b>								
WR	<b>105</b>	Cow Eff.	<b>98</b>		CEM	<b>6</b>		HB <b>93%</b>		
YR	<b>102</b>									
Udder	<b>Very Good</b>									

★★★★★ for Marbling, Rib-eye area, Calving Ease, Stayability.

## 331 Beckton Vernice K115 D

1-A 100% # 4676225 Tattoo: BKT2 K115

Birth: 3-2-22

Beckton Dominor H382 N7  
 Ref. D-3

Beckton Vernice H149 L

Beckton Dominor Y052 N6  
 Beckton Coca E847 N

Beckton Dominor W640 C5  
 Beckton Indigo W772 N

Beckton Nebula Z111 N5  
 Beckton Coca A271 N

Beckton Scamp E175 N5  
 Beckton Vernice C782 L

Beckton Scamp B720 L4  
 Beckton Belga W103 N

Beckton Likable Y124 L3  
 Beckton Vernice X754 L

BWt **56**  
 WR **113**  
 YR **109**  
 Fr. **Med**

DAM		Calv.Ease	BW	WW	YW	Milk	HPG	Stay	Maint.En.	
Age	2	EPDs	<b>16</b>	<b>-4.1</b>	<b>63</b>	<b>106</b>	<b>30</b>	<b>13</b>	<b>17</b>	<b>11.0</b>
Wt	<b>820</b>	Marb	<b>+4.6</b>		REA	<b>-0.4</b>		Bfat <b>+0.4</b>		
Prog. BW	<b>56</b>	Sire Tenderness: <b>7 / Very Good</b>								
WR	<b>113</b>	Cow Eff.	<b>113</b>		CEM	<b>6</b>		HB <b>47%</b>		
YR	<b>109</b>									
Udder	<b>Very Good</b>									

★★★★★ for Growth, Marbling, Superior Cow, Calving Ease, Stayability.

## 330 Beckton Christy K763 S

1-A 100% # 4676451 Tattoo: BSF2 K763

Birth: 4-22-22

Beckton Scamp E175 N5  
 Ref. S-1

Beckton Christy B147 A

Beckton Scamp B720 L4  
 Beckton Belga W103 N

Beckton Scamp X458 H3  
 Beckton Larkaba Y448 L

Beckton Nebula T398 V3  
 Beckton Belga T551 EP

Beckton Accent Z506 J3  
 Beckton Christy Z533 C

Beckton Accent W180 C2  
 Beckton Susan P857 JO

Beckton Clifftop W692 E3  
 Beckton Christy S151 NB

BWt **69**  
 WR **111**  
 YR **102**  
 Fr. **Med**

DAM		Calv.Ease	BW	WW	YW	Milk	HPG	Stay	Maint.En.	
Age	8	EPDs	<b>15</b>	<b>-3.7</b>	<b>57</b>	<b>96</b>	<b>34</b>	<b>10</b>	<b>17</b>	<b>5.0</b>
Wt	<b>1130</b>	Marb	<b>+3.9</b>		REA	<b>-0.7</b>		Bfat <b>+0.4</b>		
Prog. BW	<b>69</b>	Sire Tenderness: <b>9 / Outstanding</b>								
WR	<b>116</b>	Cow Eff.	<b>103</b>		CEM	<b>4</b>		HB <b>72%</b>		
YR	<b>105</b>									
Udder	<b>Very Good</b>									

★★★★★ for Marbling, Superior Cow, Calving Ease, Stayability.

## 332 Beckton Larkaba K204 S

1-A 100% # 4675257 Tattoo: BKT2 K214

Birth: 3-14-22

Beckton Scamp E175 N5  
 Ref. S-1

Beckton Larkaba B704 C

Beckton Scamp B720 L4  
 Beckton Belga W103 N

Beckton Scamp X458 H3  
 Beckton Larkaba Y448 L

Beckton Nebula T398 V3  
 Beckton Belga T551 EP

BKT Clifftop TP R288  
 Beckton Lydia S274 EP

Beckton Clifftop W692 E3  
 Beckton Larkaba U619 CT

Beckton Clifftop T3 N800  
 Beckton Larkaba M116 CE

BWt **89**  
 WR **102**  
 YR **97**  
 Fr. **Med**

DAM		Calv.Ease	BW	WW	YW	Milk	HPG	Stay	Maint.En.	
Age	8	EPDs	<b>12</b>	<b>-1.0</b>	<b>60</b>	<b>106</b>	<b>26</b>	<b>7</b>	<b>15</b>	<b>6.0</b>
Wt	<b>1280</b>	Marb	<b>+4.1</b>		REA	<b>-1.3</b>		Bfat <b>+0.4</b>		
Prog. BW	<b>80</b>	Sire Tenderness: <b>9 / Outstanding</b>								
WR	<b>102</b>	Cow Eff.	<b>84</b>		CEM	<b>5</b>		HB <b>92%</b>		
YR	<b>103</b>									
Udder	<b>Very Good</b>									

★★★★★ for Marbling, Calving Ease, Stayability.



Beckton Accent W180 (A-1)

The goal for Beckton's program has always been to develop breeding seedstock which offer increased levels of performance for the commercial cattleman. Increased performance does not mean maximizing weight and size, which have already reached the upper limit of economic value for the packer and consumer. It does, however, mean increasing performance related to calving percentage and weaning percentage; and increasing performance related to cow maintenance requirements and "pounds of calf per acre" efficiency.

## A-1 Beckton Accent W180 C2

1-A 100% # 1331776 Tattoo: BKB9 W180

Birth: 3-12-09

- Beckton Cody KH M390
- Beckton Cody K G701
- Beckton Tamara J124 HR
- Beckton Cody K1 P014**
- Beckton Rose M126 WR
- Beckton Warrior T C371
- Beckton Rose D741 LN
- Beckton Cherokee N N479
- Beckton Christy R046 CQ**
- Beckton Christy N740 HR
- Beckton Herald FJ J776
- Beckton Christy K141 VG

BWt	<b>77</b>
WR	<b>116</b>
ADG	<b>4.23</b>
YR	<b>114</b>
Scr.	<b>39</b>
Fr.	<b>5.5</b>

DAM	
Age	4
Wt	1140
Wean Pct.	57%
Cow Eff.	121

Calv.Ease	BW	WW	YW	Milk	HPG	Stay	Maint.En.	
EPDs	<b>18</b>	<b>-4.7</b>	<b>62</b>	<b>95</b>	<b>27</b>	<b>15</b>	<b>22</b>	<b>-2.0</b>
Acc.	(.69)	(.86)	(.83)	(.84)	(.72)	(.61)	(.60)	(.54)
Marb	<b>+.39</b>	(.53)	REA	<b>+.14</b>	(.59)	Bfat	<b>+.03</b>	(.44)

★★★★★ for Low Maintenance, Growth, Gainability, Marbling, Rib-eye area, High Cow Efficiency, Calving Ease.

## A-3 Beckton Accent B740 W3

1-A 100% # 1705638 Tattoo: BKT4 B740

Birth: 4-16-14

- Beckton Cody K1 P014
- Beckton Cody KH M390
- Beckton Rose M126 WR
- Beckton Accent W180 C2**
- Beckton Christy R046 CQ
- Beckton Cherokee N N479
- Beckton Christy N740 HR
- Beckton Warrior W534 N4
- Beckton Lana Y033 W**
- Beckton Lana W370 E
- BKT Larkeisa S055 NB
- Beckton Epic K4 N795
- Beckton Lana P520 LN

BWt	<b>71</b>
WR	<b>104</b>
ADG	<b>3.93</b>
YR	<b>104</b>
Scr.	<b>35</b>
Fr.	<b>5.5</b>

DAM	
Age	3
Wt	982
Wean Pct.	50%
Cow Eff.	105

Calv.Ease	BW	WW	YW	Milk	HPG	Stay	Maint.En.	
EPDs	<b>20</b>	<b>-6.0</b>	<b>66</b>	<b>103</b>	<b>26</b>	<b>12</b>	<b>13</b>	<b>2.0</b>
Acc.	(.35)	(.62)	(.57)	(.57)	(.32)	(.11)	(.24)	(.23)
Marb	<b>+.43</b>	(.20)	REA	<b>+.33</b>	(.29)	Bfat	<b>+.03</b>	(.14)

★★★★★ for Gainability, Marbling, Rib-eye area, Calving Ease.

## A-2 Beckton Accent B549 N3

1-A 100% # 1705673 Tattoo: BKB4 B549

Birth: 3-31-14

- Beckton Cody K1 P014
- Beckton Cody KH M390
- Beckton Rose M126 WR
- Beckton Accent W180 C2**
- Beckton Christy R046 CQ
- Beckton Cherokee N N479
- Beckton Christy N740 HR
- Beckton Nebula T398 V3
- Beckton Minerva Y654 N**
- Beckton Minerva M369 LO
- Beckton Nebula L P093
- Beckton Minerva J615 VG
- Beckton Loki F251
- Beckton Minerva H403 LN

BWt	<b>75</b>
WR	<b>119</b>
ADG	<b>4.77</b>
YR	<b>122</b>
Scr.	<b>39</b>
Fr.	<b>6.0</b>

DAM	
Age	3
Wt	1046
Wean Pct.	54%
Cow Eff.	114

Calv.Ease	BW	WW	YW	Milk	HPG	Stay	Maint.En.	
EPDs	<b>13</b>	<b>-2.2</b>	<b>74</b>	<b>126</b>	<b>22</b>	<b>13</b>	<b>16</b>	<b>16.0</b>
Acc.	(.50)	(.76)	(.72)	(.73)	(.44)	(.19)	(.35)	(.32)
Marb	<b>+.49</b>	(.27)	REA	<b>+.22</b>	(.41)	Bfat	<b>+.04</b>	(.21)

★★★★★ for Growth, Gainability, Marbling, Rib-eye area, Calving Ease.

## A-4 Beckton Accent F602 L3

1-A 100% # 3987378 Tattoo: BKT8 F602

Birth: 4-2-18

- Beckton Cody K1 P014
- Beckton Cody KH M390
- Beckton Rose M126 WR
- Beckton Accent W180 C2**
- Beckton Christy R046 CQ
- Beckton Cherokee N N479
- Beckton Christy N740 HR
- Beckton Likable U130 L2
- Beckton Lana B670 L**
- Beckton Lana Y541 W
- Beckton Likable S633
- Beckton Kit S478 LN
- Beckton Warrior T248 L5
- Beckton Lana S074 EP

BWt	<b>61</b>
WR	<b>107</b>
ADG	<b>3.26</b>
YR	<b>111</b>
Scr.	<b>36</b>
Fr.	<b>5.5</b>

DAM	
Age	4
Wt	875
Wean Pct.	63%
Cow Eff.	133

Calv.Ease	BW	WW	YW	Milk	HPG	Stay	Maint.En.	
EPDs	<b>18</b>	<b>-4.8</b>	<b>62</b>	<b>100</b>	<b>25</b>	<b>14</b>	<b>19</b>	<b>-5.0</b>
Acc.	(.36)	(.60)	(.54)	(.55)	(.29)	(.11)	(.24)	(.24)
Marb	<b>+.37</b>	(.20)	REA	<b>+.35</b>	(.28)	Bfat	<b>+.03</b>	(.17)

★★★★★ for Low Maintenance, Growth, Marbling, Rib-eye area, High Cow Efficiency, Calving Ease.

## A-5 Beckton Accent G107 C4

1-A 100% # 4170888 Tattoo: BKT9 G107

Birth: 3-8-19

Beckton Accent E172 L3 Beckton Indigo Y406 L Beckton Pine Marie E206 D BKT Pine Marie W404 J	Beckton Accent W180 C2 Beckton Cody K1 P014 Beckton Christy R046 CQ Beckton Likable U130 L2 Beckton Indigo R745 WR TR Ricardo DOS Beckton Lana U182 JC Beckton Jet L P491 BKT Pine Marie R056 CQ	BWT <b>59</b> WR <b>115</b> ADG <b>3.82</b> YR <b>116</b> Scr. <b>34</b> Fr. <b>5.0</b>
---	--	--

DAM		Calv.Ease	BW	WW	YW	Milk	HPG	Stay	Maint.En.	
Age	2	EPDs	<b>22</b>	<b>-7.3</b>	<b>51</b>	<b>89</b>	<b>33</b>	<b>11</b>	<b>19</b>	<b>0.0</b>
Wt	885	Acc.	(.33)	(.58)	(.56)	(.55)	(.18)	(.08)	(.18)	(.16)
Wean Pct.	51%	Marb	<b>+0.43</b> (.16)		REA	<b>+0.23</b> (.26)		Bfat	<b>+0.03</b> (.11)	
Cow Eff.	108									

★★★★★ for Low Maintenance, Growth, Gainability, Marbling, Rib-eye area, Calving Ease.

## A-8 Beckton Accent H121 H5

1-A 100% # 4377431 Tattoo: BKT0 H121

Birth: 3-7-20

Beckton Accent F363 L4 Beckton Coca B062 L Beckton Christy F670 H Beckton Christy Z229 N	Beckton Accent B549 N3 Beckton Accent W180 C2 Beckton Minerva Y654 N Beckton Likable Z057 L4 Beckton Coca Z037 J Beckton Heritage B612 J4 Beckton Heritage X403 L3 Beckton Lana N291 JC Beckton Nebula X603 J4 Beckton Christy X457 N	BWT <b>57</b> WR <b>97</b> ADG <b>4.21</b> YR <b>108</b> Scr. <b>37</b> Fr. <b>5.5</b>
---	--	---

DAM		Calv.Ease	BW	WW	YW	Milk	HPG	Stay	Maint.En.	
Age	2	EPDs	<b>18</b>	<b>-3.3</b>	<b>58</b>	<b>95</b>	<b>32</b>	<b>13</b>	<b>15</b>	<b>2.0</b>
Wt	835	Acc.	(.30)	(.50)	(.44)	(.42)	(.18)	(.07)	(.17)	(.09)
Wean Pct.	50%	Marb	<b>+0.45</b> (.10)		REA	<b>+0.07</b> (.22)		Bfat	<b>+0.05</b> (.08)	
Cow Eff.	106									

★★★★★ for Growth, Gainability, Marbling, Calving Ease.

## A-6 Beckton Accent G208 N3

1-A 100% # 4170384 Tattoo: BKT9 G208

Birth: 3-15-19

Beckton Accent B553 L2 Beckton Lana X839 L Beckton Sierra A836 N Beckton Sierra S847 WR	Beckton Accent U777 C2 Beckton Cody K1 P014 Beckton Susan R022 CQ Beckton Legend S670 Beckton Lana S371 DM Beckton Nebula P P707 BKT Larkeisa T310 JC Beckton Warrior T1 H281 Beckton Sierra N766 HR	BWT <b>90</b> WR <b>118</b> ADG <b>4.08</b> YR <b>119</b> Scr. <b>37</b> Fr. <b>5.5</b>
--	--	--

DAM		Calv.Ease	BW	WW	YW	Milk	HPG	Stay	Maint.En.	
Age	6	EPDs	<b>10</b>	<b>1.0</b>	<b>77</b>	<b>127</b>	<b>21</b>	<b>13</b>	<b>16</b>	<b>10.0</b>
Wt	1200	Acc.	(.26)	(.50)	(.47)	(.48)	(.20)	(.05)	(.17)	(.19)
Wean Pct.	53%	Marb	<b>+0.30</b> (.15)		REA	<b>+0.18</b> (.23)		Bfat	<b>+0.03</b> (.11)	
Cow Eff.	112									

★★★★★ for Growth, Gainability, Marbling, Rib-eye area.

## A-9 Beckton Accent H410 A4

1-A 100% # 4378007 Tattoo: BSF0 H410

Birth: 3-28-20

Beckton Accent B549 N3 Beckton Minerva Y654 N Beckton Minola C198 A Beckton Minola A330 S	Beckton Accent W180 C2 Beckton Cody K1 P014 Beckton Christy R046 CQ Beckton Nebula T398 V3 Beckton Minerva M369 L0 Beckton Accent A485 C3 Beckton Accent U777 C2 Beckton Tamara R175 CQ Beckton Scamp X494 E3 Beckton Minola P611 JL	BWT <b>71</b> WR <b>124</b> ADG <b>3.45</b> YR <b>116</b> Scr. <b>36</b> Fr. <b>5.5</b>
--	---	--

DAM		Calv.Ease	BW	WW	YW	Milk	HPG	Stay	Maint.En.	
Age	5	EPDs	<b>16</b>	<b>-4.1</b>	<b>66</b>	<b>108</b>	<b>28</b>	<b>13</b>	<b>17</b>	<b>6.0</b>
Wt	960	Acc.	(.27)	(.45)	(.43)	(.44)	(.22)	(.02)	(.21)	(.17)
Wean Pct.	69%	Marb	<b>+0.33</b> (.14)		REA	<b>+0.35</b> (.22)		Bfat	<b>+0.04</b> (.10)	
Cow Eff.	144									

★★★★★ for Growth, Marbling, Rib-eye area, High Cow Efficiency, Calving Ease.

## A-7 Beckton Accent H059 N5

1-A 100% # 4378263 Tattoo: BSF0 H059

Birth: 2-24-20

Beckton Accent F363 L4 Beckton Coca B062 L Beckton Encino F751 N Beckton Encino A442 J	Beckton Accent B549 N3 Beckton Accent W180 C2 Beckton Minerva Y654 N Beckton Likable Z057 L4 Beckton Coca Z037 J Beckton Nebula T398 V3 Beckton Firefly T003 JC Beckton Julian W743 H5 Beckton Encino X075 C	BWT <b>57</b> WR <b>114</b> ADG <b>4.43</b> YR <b>123</b> Scr. <b>37</b> Fr. <b>5.5</b>
---	--	--

DAM		Calv.Ease	BW	WW	YW	Milk	HPG	Stay	Maint.En.	
Age	2	EPDs	<b>19</b>	<b>-4.9</b>	<b>64</b>	<b>119</b>	<b>27</b>	<b>12</b>	<b>16</b>	<b>11.0</b>
Wt	800	Acc.	(.28)	(.43)	(.39)	(.39)	(.16)	(.05)	(.14)	(.09)
Wean Pct.	63%	Marb	<b>+0.40</b> (.11)		REA	<b>+0.17</b> (.21)		Bfat	<b>+0.04</b> (.09)	
Cow Eff.	132									

★★★★★ for Growth, Gainability, Marbling, Rib-eye area, High Cow Efficiency, Calving Ease.

## B-1 Beckton Hughes F076 H3

1-A 100% # 3987998 Tattoo: BKT8 F076

Birth: 2-25-18

Beckton Hughes D589 S2 Beckton Sierra Z353 S Beckton Emera D487 B Beckton Emera A186 A	Bieber H Hughes W109 Basin Hobo 0545 Basin Rose 06T0 Beckton Scamp X494 E3 Beckton Sierra X555 N Bieber H Hughes W109 Basin Hobo 0545 Basin Rose 06T0 Beckton Accent W180 C2 Beckton Emera U675 CQ	BWT <b>64</b> WR <b>103</b> ADG <b>2.98</b> YR <b>103</b> Scr. <b>32</b> Fr. <b>5.5</b>
---	---	--

DAM		Calv.Ease	BW	WW	YW	Milk	HPG	Stay	Maint.En.	
Age	2	EPDs	<b>18</b>	<b>-3.9</b>	<b>58</b>	<b>93</b>	<b>26</b>	<b>16</b>	<b>18</b>	<b>3.0</b>
Wt	930	Acc.	(.31)	(.58)	(.55)	(.54)	(.20)	(.06)	(.16)	(.15)
Wean Pct.	51%	Marb	<b>+0.28</b> (.18)		REA	<b>+0.00</b> (.23)		Bfat	<b>+0.03</b> (.15)	
Cow Eff.	106									

★★★★★ for Marbling, Calving Ease.

## C-1 Beckton Cardinal E673 L

1-A 100% # 3776785 Tattoo: BKT7 E673

Birth: 4-12-17	TR Ricardo DOS	BFCK Cherokee Cnyn 4912	BWt	<b>51</b>
	TR Double Eagle ZT220	TR Dyna LT111	WR	<b>104</b>
	Beckton Lana U182 JC	Beckton Justice C1 R483	ADG	<b>2.69</b>
		Beckton Lana H544 WR	YR	<b>97</b>
	Beckton Legend U331 E2	Beckton Legend S670	Scr.	<b>33</b>
<b>Beckton Larkaba A911 L</b>	Beckton Lana S669 EP	Beckton Warhawk N560	Fr.	<b>5.0</b>
	Beckton Larkaba T418 WA	Beckton Larkaba P783 JL		

<b>DAM</b>	Calv.Ease	BW	WW	YW	Milk	HPG	Stay	Maint.En.
Age <b>4</b>	EPDs <b>24</b>	<b>-8.1</b>	<b>64</b>	<b>104</b>	<b>29</b>	<b>13</b>	<b>19</b>	<b>6.0</b>
Wt <b>1035</b>	Acc. (.34)	(.71)	(.66)	(.66)	(.27)	(.07)	(.23)	(.24)
Wean Pct. <b>51%</b>								
Cow Eff. <b>108</b>	Marb <b>+.59</b>	(.21)	REA <b>+.36</b>	(.28)	Bfat <b>+.04</b>	(.17)		

★★★★★ for Marbling, Rib-eye area, Calving Ease.

## D-1 Beckton Dominor F263 N8

1-A 100% # 3987796 Tattoo: BKT8 F263

Birth: 3-15-18	Beckton Dominor Y005 V6	Beckton Dominor W640 C5	BWt	<b>72</b>
	Beckton Dominor A378 W7	Beckton Belga W108 V	WR	<b>119</b>
	Beckton Lana Y541 W	Beckton Warrior T248 L5	ADG	<b>2.50</b>
		Beckton Lana S074 EP	YR	<b>107</b>
	Beckton Nebula EN S347	Beckton Nebula E P084	Scr.	<b>36</b>
<b>Beckton Larkaba W272 N</b>	Beckton Lana E P530 NB	Beckton Herald FJ J776	Fr.	<b>5.5</b>
	Beckton Larkaba N643 HR	Beckton Larkaba J765 CH		

<b>DAM</b>	Calv.Ease	BW	WW	YW	Milk	HPG	Stay	Maint.En.
Age <b>9</b>	EPDs <b>20</b>	<b>-3.8</b>	<b>54</b>	<b>87</b>	<b>36</b>	<b>16</b>	<b>15</b>	<b>2.0</b>
Wt <b>980</b>	Acc. (.36)	(.67)	(.63)	(.64)	(.27)	(.15)	(.29)	(.22)
Wean Pct. <b>65%</b>								
Cow Eff. <b>137</b>	Marb <b>+.49</b>	(.17)	REA <b>+.14</b>	(.28)	Bfat <b>+.05</b>	(.16)		

★★★★★ for Growth, Marbling, Rib-eye area, High Cow Efficiency, Calving Ease.

## C-2 Beckton Cardinal G043 C2

1-A 100% # 4170880 Tattoo: BKT9 G043

Birth: 2-24-19	TR Double Eagle ZT220	TR Ricardo DOS	BWt	<b>59</b>
	Beckton Cardinal E673 L	Beckton Lana U182 JC	WR	<b>117</b>
	Beckton Larkaba A911 L	Beckton Legend U331 E2	ADG	<b>3.87</b>
		Beckton Larkaba T418 WA	YR	<b>119</b>
	TR Double Eagle ZT220	TR Ricardo DOS	Scr.	<b>34</b>
<b>Beckton Minerva E181 D</b>	Beckton Lana U182 JC	Beckton Julian G3 P608	Fr.	<b>5.5</b>
	Beckton Minerva W901 J	Beckton Minerva L344 CH		

<b>DAM</b>	Calv.Ease	BW	WW	YW	Milk	HPG	Stay	Maint.En.
Age <b>2</b>	EPDs <b>21</b>	<b>-4.8</b>	<b>64</b>	<b>107</b>	<b>30</b>	<b>13</b>	<b>18</b>	<b>8.0</b>
Wt <b>725</b>	Acc. (.34)	(.57)	(.55)	(.54)	(.20)	(.06)	(.14)	(.15)
Wean Pct. <b>61%</b>								
Cow Eff. <b>127</b>	Marb <b>+.36</b>	(.19)	REA <b>+.40</b>	(.28)	Bfat <b>+.03</b>	(.12)		

★★★★★ for Growth, Gainability, Marbling, Rib-eye area, High Cow Efficiency, Calving Ease.

## D-2 Beckton Dominor G402 A9

1-A 100% # 4170856 Tattoo: BKT9 G402

Birth: 3-26-19	Beckton Dominor A378 W7	Beckton Dominor Y005 V6	BWt	<b>65</b>
	Beckton Dominor D254 N8	Beckton Lana Y541 W	WR	<b>117</b>
	Beckton Indigo W772 N	Beckton Nebula T398 V3	ADG	<b>3.98</b>
		Beckton Indigo T613 JT	YR	<b>119</b>
	Beckton Accent B549 N3	Beckton Accent W180 C2	Scr.	<b>36</b>
<b>Beckton Lana D273 A</b>	Beckton Minerva Y654 N	Beckton Scamp X494 E3	Fr.	<b>5.5</b>
	Beckton Lana B666 S	Beckton Lana Y022 N		

<b>DAM</b>	Calv.Ease	BW	WW	YW	Milk	HPG	Stay	Maint.En.
Age <b>3</b>	EPDs <b>21</b>	<b>-7.0</b>	<b>48</b>	<b>81</b>	<b>25</b>	<b>13</b>	<b>16</b>	<b>2.0</b>
Wt <b>1120</b>	Acc. (.24)	(.56)	(.49)	(.46)	(.19)	(.04)	(.16)	(.16)
Wean Pct. <b>47%</b>								
Cow Eff. <b>99</b>	Marb <b>+.37</b>	(.15)	REA <b>+.13</b>	(.24)	Bfat <b>+.05</b>	(.09)		

★★★★★ for Growth, Gainability, Marbling, Rib-eye area, Calving Ease.

## C-3 Beckton Cardinal H671 E2

1-A 100% # 4376801 Tattoo: BKT0 H671

Birth: 4-18-20	TR Double Eagle ZT220	TR Ricardo DOS	BWt	<b>74</b>
	Beckton Cardinal E673 L	Beckton Lana U182 JC	WR	<b>113</b>
	Beckton Larkaba A911 L	Beckton Legend U331 E2	ADG	<b>4.25</b>
		Beckton Larkaba T418 WA	YR	<b>121</b>
	Beckton Epic X464 L5	Beckton Epic K6 S569	Scr.	<b>34</b>
<b>Beckton Tamara B700 E</b>	Beckton Lana M393 LN	Beckton Nebula U206 V3	Fr.	<b>5.5</b>
	Beckton Tamara Y585 N	Beckton Tamara U770 JL		

<b>DAM</b>	Calv.Ease	BW	WW	YW	Milk	HPG	Stay	Maint.En.
Age <b>6</b>	EPDs <b>18</b>	<b>-4.5</b>	<b>67</b>	<b>114</b>	<b>30</b>	<b>12</b>	<b>17</b>	<b>1.0</b>
Wt <b>985</b>	Acc. (.20)	(.44)	(.38)	(.39)	(.18)	(.03)	(.19)	(.11)
Wean Pct. <b>61%</b>								
Cow Eff. <b>129</b>	Marb <b>+.55</b>	(.12)	REA <b>+.25</b>	(.18)	Bfat <b>+.05</b>	(.08)		

★★★★★ for Growth, Gainability, Marbling, Rib-eye area, High Cow Efficiency, Calving Ease.

## D-3 Beckton Dominor H382 N7

1-A 100% # 4377121 Tattoo: BKT0 H382

Birth: 3-27-20	Beckton Dominor W640 C5	Beckton Dominor Z1 R610	BWt	<b>67</b>
	Beckton Dominor Y052 N6	Beckton Mona R166 CQ	WR	<b>131</b>
	Beckton Indigo W772 N	Beckton Nebula T398 V3	ADG	<b>4.60</b>
		Beckton Indigo T613 JT	YR	<b>133</b>
	Beckton Nebula Z111 N5	Beckton Nebula X096 N4	Scr.	<b>35</b>
<b>Beckton Coca E847 N</b>	Beckton Minola X670 N	Beckton Nebula P P707	Fr.	<b>5.5</b>
	Beckton Coca A271 N	Beckton Coca X675 N		

<b>DAM</b>	Calv.Ease	BW	WW	YW	Milk	HPG	Stay	Maint.En.
Age <b>3</b>	EPDs <b>13</b>	<b>-3.4</b>	<b>69</b>	<b>119</b>	<b>26</b>	<b>15</b>	<b>15</b>	<b>13.0</b>
Wt <b>1000</b>	Acc. (.27)	(.45)	(.40)	(.40)	(.20)	(.08)	(.19)	(.13)
Wean Pct. <b>61%</b>								
Cow Eff. <b>129</b>	Marb <b>+.46</b>	(.13)	REA <b>-.11</b>	(.24)	Bfat <b>+.05</b>	(.11)		

★★★★★ for Growth, Gainability, Marbling, High Cow Efficiency, Calving Ease.



### D-4 Beckton Dominor H423 N9

1-A 100% # 4377997 Tattoo: BSF0 H423

Birth: 3-28-20

- Beckton Dominor A378 W7 < Beckton Dominor Y005 V6
- Beckton Dominor D254 N8 < Beckton Lana Y541 W
- Beckton Indigo W772 N < Beckton Nebula T398 V3
- Beckton Indigo T613 JT < Beckton Indigo T613 JT
- Beckton Nebula W022 D3 < Beckton Nebula T269 E2
- Beckton Lana Y130 N < Beckton Eola T070 DM
- Beckton Lana W525 D < Beckton Dominor Z1 R610
- Beckton Lana S520 JO < Beckton Lana S520 JO

<b>DAM</b>	Age <b>9</b>	Calv.Ease	BW	WW	YW	Milk	HPG	Stay	Maint.En.	
Age	9	EPDs	<b>19</b>	<b>-5.8</b>	<b>51</b>	<b>85</b>	<b>31</b>	<b>13</b>	<b>19</b>	<b>4.0</b>
Wt	1115	Acc.	(.26)	(.44)	(.41)	(.42)	(.22)	(.17)	(.17)	
Wean Pct.	50%	Marb	<b>+.43</b> (.14)		REA	<b>+.05</b> (.21)		Bfat	<b>+.04</b> (.10)	
Cow Eff.	105									

★★★★★ for Growth, Gainability, Marbling, Calving Ease.

### E-3 Beckton Epic H335 A8

1-A 100% # 4377181 Tattoo: BKT0 H335

Birth: 3-24-20

- Beckton Epic B483 N6 < Beckton Epic U749 D5
- Beckton Epic D001 L7 < BKT Pine Marie X339 N
- Beckton Legend U331 E2 < Beckton Legend U331 E2
- Beckton Mona B713 L < Beckton Mona U564 JT
- Beckton Accent W180 C2 < Beckton Cody K1 P014
- Beckton Coca D239 A < Beckton Christy R046 CQ
- Beckton Coca T454 NX < Beckton Nexus L016
- Beckton Coca P597 CD < Beckton Coca P597 CD

<b>DAM</b>	Age <b>4</b>	Calv.Ease	BW	WW	YW	Milk	HPG	Stay	Maint.En.	
Age	4	EPDs	<b>17</b>	<b>-5.4</b>	<b>64</b>	<b>114</b>	<b>30</b>	<b>12</b>	<b>18</b>	<b>10.0</b>
Wt	1075	Acc.	(.20)	(.45)	(.38)	(.40)	(.16)	(.04)	(.16)	(.14)
Wean Pct.	54%	Marb	<b>+.39</b> (.11)		REA	<b>+.15</b> (.19)		Bfat	<b>+.05</b> (.08)	
Cow Eff.	113									

★★★★★ for Growth, Gainability, Marbling, Rib-eye area, Calving Ease.

### E-1 Beckton Epic G227 A7

1-A 100% # 4170306 Tattoo: BKT9 G227

Birth: 3-16-19

- Beckton Epic X464 L5 < Beckton Epic K6 S569
- Beckton Epic B310 J6 < Beckton Lana M393 LN
- Beckton Minerva Y116 J < Beckton Julian W743 H5
- Beckton Minerva W081 N < Beckton Minerva W081 N
- Beckton Accent W180 C2 < Beckton Cody K1 P014
- Beckton Lana Z916 A < Beckton Christy R046 CQ
- Beckton Lana N664 JL < Beckton Julian G1 J526
- Beckton Lana H533 LN < Beckton Lana H533 LN

<b>DAM</b>	Age <b>7</b>	Calv.Ease	BW	WW	YW	Milk	HPG	Stay	Maint.En.	
Age	7	EPDs	<b>15</b>	<b>-2.5</b>	<b>67</b>	<b>101</b>	<b>28</b>	<b>14</b>	<b>17</b>	<b>2.0</b>
Wt	1180	Acc.	(.27)	(.52)	(.47)	(.46)	(.23)	(.06)	(.20)	(.16)
Wean Pct.	51%	Marb	<b>+.37</b> (.13)		REA	<b>+.01</b> (.23)		Bfat	<b>+.03</b> (.10)	
Cow Eff.	107									

★★★★★ for Growth, Marbling, Calving Ease.

### H-1 Beckton Heritage F615 L5

1-A 100% # 3988420 Tattoo: BSF8 F615

Birth: 4-4-18

- Beckton Heritage X403 L3 < Beckton Heritage T270 J2
- Beckton Heritage B612 J4 < Beckton Indigo H150 LN
- Beckton Lana N291 JC < Beckton Justice G302
- Beckton Lana H725 CH < Beckton Lana H725 CH
- Beckton Likable U130 L2 < Beckton Likable S633
- Beckton Mona X022 L < Beckton Kit S478 LN
- Beckton Mona U584 CD < Beckton Cody K2 R168
- Beckton Mona P539 CH < Beckton Mona P539 CH

<b>DAM</b>	Age <b>8</b>	Calv.Ease	BW	WW	YW	Milk	HPG	Stay	Maint.En.	
Age	8	EPDs	<b>9</b>	<b>-2.5</b>	<b>66</b>	<b>97</b>	<b>28</b>	<b>13</b>	<b>16</b>	<b>-6.0</b>
Wt	1105	Acc.	(.37)	(.62)	(.56)	(.57)	(.28)	(.06)	(.21)	(.23)
Wean Pct.	58%	Marb	<b>+.41</b> (.19)		REA	<b>+.11</b> (.28)		Bfat	<b>+.04</b> (.13)	
Cow Eff.	121									

★★★★★ for Low Maintenance, Growth, Gainability, Marbling, High Cow Efficiency, Calving Ease.

### E-2 Beckton Epic H312 A8

1-A 100% # 4378077 Tattoo: BSF0 H312

Birth: 3-23-20

- Beckton Epic B483 N6 < Beckton Epic U749 D5
- Beckton Epic D001 L7 < BKT Pine Marie X339 N
- Beckton Mona B713 L < Beckton Legend U331 E2
- Beckton Legend U331 E2 < Beckton Mona U564 JT
- Beckton Accent Y260 L3 < Beckton Accent W180 C2
- Beckton Larkaba B352 A < Beckton Lana W463 L
- Beckton Larkaba Y156 N < Beckton Nebula T398 V3
- Beckton Larkaba U274 JL < Beckton Larkaba U274 JL

<b>DAM</b>	Age <b>6</b>	Calv.Ease	BW	WW	YW	Milk	HPG	Stay	Maint.En.	
Age	6	EPDs	<b>14</b>	<b>-2.9</b>	<b>65</b>	<b>106</b>	<b>31</b>	<b>11</b>	<b>20</b>	<b>13.0</b>
Wt	1210	Acc.	(.20)	(.45)	(.40)	(.43)	(.17)	(.02)	(.13)	(.15)
Wean Pct.	51%	Marb	<b>+.41</b> (.13)		REA	<b>+.11</b> (.19)		Bfat	<b>+.05</b> (.08)	
Cow Eff.	108									

★★★★★ for Growth, Gainability, Marbling, Calving Ease.

### H-2 Beckton Heritage H181 N5

1-A 100% # 4377359 Tattoo: BKT0 H181

Birth: 3-14-20

- Beckton Heritage X403 L3 < Beckton Heritage T270 J2
- Beckton Heritage C477 J4 < Beckton Indigo H150 LN
- Beckton Ruth Z858 J < Beckton Julian U699 L5
- Beckton Ruth U557 JT < Beckton Ruth U557 JT
- Beckton Nebula T269 E2 < Beckton Nebula M045
- Beckton Sierra Y441 N < Beckton Ruth M967 EP
- Beckton Sierra S120 HW < Beckton Hawk P248
- Beckton Sierra P348 JO < Beckton Sierra P348 JO

<b>DAM</b>	Age <b>9</b>	Calv.Ease	BW	WW	YW	Milk	HPG	Stay	Maint.En.	
Age	9	EPDs	<b>13</b>	<b>-2.9</b>	<b>60</b>	<b>97</b>	<b>34</b>	<b>11</b>	<b>16</b>	<b>0.0</b>
Wt	1115	Acc.	(.25)	(.46)	(.41)	(.42)	(.21)	(.04)	(.17)	(.17)
Wean Pct.	54%	Marb	<b>+.29</b> (.13)		REA	<b>+.11</b> (.22)		Bfat	<b>+.04</b> (.10)	
Cow Eff.	113									

★★★★★ for Low Maintenance, Growth, Gainability, Marbling, Calving Ease.

## J-1 Beckton Julian GG B571

1-A 100% # 387580 Tattoo: WF2 B571

Birth: 3-27-92	Beckton Julian 6592	Beckton Trojan 5253	BWt	<b>65</b>
		Lchmn Christy 2339	WR	<b>113</b>
<b>Beckton Julian 7526G</b>	Bkt Belga 6746 GS	Beckton Gisa 4454	ADG	<b>3.18</b>
		Beckton Lalaxigu -2	YR	<b>112</b>
	Beckton Julian 7526G	Beckton Julian 6592	Scr.	<b>33</b>
<b>Bkt Marta 9A13 JL</b>	Bkt Marta 6498 XM	Bkt Belga 6746 GS	Fr.	<b>5.0</b>
		Beckton Xime 4736		
		Beckton Marwa -K		

<b>DAM</b>	Calv.Ease	BW	WW	YW	Milk	HPG	Stay	Maint.En.
Age <b>3</b>	EPDs <b>20</b>	<b>-7.3</b>	<b>48</b>	<b>75</b>	<b>24</b>	<b>17</b>	<b>14</b>	<b>-7.0</b>
Wt <b>1015</b>	Acc. (.88)	(.94)	(.92)	(.92)	(.89)	(.82)	(.82)	(.58)
Wean Pct. <b>56%</b>								
Cow Eff. <b>118</b>	Marb <b>+.48</b> (.80)		REA <b>+.11</b> (.83)		Bfat <b>+.04</b> (.77)			

★★★★★ for Low Maintenance, Growth, Marbling, High Cow Efficiency, Calving Ease.



Beckton Julian B571 (J-1)

## J-2 Beckton Julian Z382 J7

1-A 100% # 1544962 Tattoo: BKT3 Z382

Birth: 3-20-12	Beckton Julian U699 L5	Beckton Julian G1 J526	BWt	<b>47</b>
		Beckton Rose L311 LN	WR	<b>125</b>
<b>Beckton Julian X721 E6</b>	Beckton Lana U329 EP	Beckton Epic K6 S569	ADG	<b>2.99</b>
		Beckton Lana S477 LN	YR	<b>113</b>
	Beckton Julian U699 L5	Beckton Julian G1 J526	Scr.	<b>33</b>
<b>Beckton Larkaba X064 J</b>	Beckton Larkaba U475 CT	Beckton Rose L311 LN	Fr.	<b>5.0</b>
		BKT Clifftop TP R288		
		Beckton Larkaba R809 NB		

<b>DAM</b>	Calv.Ease	BW	WW	YW	Milk	HPG	Stay	Maint.En.
Age <b>2</b>	EPDs <b>23</b>	<b>-8.7</b>	<b>57</b>	<b>88</b>	<b>28</b>	<b>14</b>	<b>21</b>	<b>-5.0</b>
Wt <b>755</b>	Acc. (.51)	(.71)	(.67)	(.68)	(.51)	(.37)	(.34)	(.41)
Wean Pct. <b>80%</b>								
Cow Eff. <b>168</b>	Marb <b>+.37</b> (.34)		REA <b>-.05</b> (.39)		Bfat <b>+.06</b> (.29)			

★★★★★ for Low Maintenance, Growth, Marbling, High Cow Efficiency, Calving Ease.

## J-4 Beckton Julian F067 L7

1-A 100% # 3988836 Tattoo: BSF8 F067

Birth: 2-23-18	Beckton Julian X465 J5	Beckton Julian G5 S107	BWt	<b>53</b>
		Beckton Suffeina P643 JL	WR	<b>113</b>
<b>Beckton Julian D551 C6</b>	Beckton Tamara W550 A	Beckton Cody K1 P014	ADG	<b>4.28</b>
		Beckton Tamara R175 CQ	YR	<b>120</b>
	Beckton Likable Z057 L4	Beckton Likable X445 J3	Scr.	<b>34</b>
<b>Beckton Indigo D786 L</b>	Beckton Indigo Y026 N	Beckton Minola X107 L	Fr.	<b>6.0</b>
		Beckton Nebula W065 C3		
		Beckton Indigo W866 A		

<b>DAM</b>	Calv.Ease	BW	WW	YW	Milk	HPG	Stay	Maint.En.
Age <b>2</b>	EPDs <b>19</b>	<b>-3.9</b>	<b>60</b>	<b>125</b>	<b>24</b>	<b>13</b>	<b>12</b>	<b>18.0</b>
Wt <b>800</b>	Acc. (.39)	(.67)	(.61)	(.59)	(.20)	(.07)	(.15)	(.17)
Wean Pct. <b>61%</b>								
Cow Eff. <b>128</b>	Marb <b>+.51</b> (.23)		REA <b>+.05</b> (.29)		Bfat <b>+.04</b> (.18)			

★★★★★ for Growth, Gainability, Marbling, High Cow Efficiency, Calving Ease.

## J-3 Beckton Julian E423 N8

1-A 100% # 3777967 Tattoo: BSF7 E423

Birth: 3-24-17	Beckton Julian X721 E6	Beckton Julian U699 L5	BWt	<b>53</b>
		Beckton Lana U329 EP	WR	<b>106</b>
<b>Beckton Julian Z382 J7</b>	Beckton Larkaba X064 J	Beckton Julian U699 L5	ADG	<b>2.97</b>
		Beckton Larkaba U475 CT	YR	<b>105</b>
	Beckton Nebula Z111 N5	Beckton Nebula X096 N4	Scr.	<b>37</b>
<b>Beckton Belga B004 N</b>	Beckton Belga Z031 N	Beckton Minola X670 N	Fr.	<b>5.0</b>
		Beckton Nebula X096 N4		
		Beckton Belga X736 E		

<b>DAM</b>	Calv.Ease	BW	WW	YW	Milk	HPG	Stay	Maint.En.
Age <b>3</b>	EPDs <b>22</b>	<b>-8.3</b>	<b>53</b>	<b>84</b>	<b>27</b>	<b>13</b>	<b>17</b>	<b>1.0</b>
Wt <b>1010</b>	Acc. (.38)	(.64)	(.61)	(.62)	(.31)	(.08)	(.22)	(.28)
Wean Pct. <b>52%</b>								
Cow Eff. <b>109</b>	Marb <b>+.54</b> (.20)		REA <b>-.30</b> (.30)		Bfat <b>+.05</b> (.17)			

★★★★★ for Growth, Marbling, Calving Ease.

## J-5 Beckton Jet G441 N2

1-A 100% # 4170464 Tattoo: BKT9 G441

Birth: 3-27-19	TR Julian Lt151	Beckton Julian GG B571	BWt	<b>66</b>
		MS Geometric 917	WR	<b>104</b>
<b>Beckton Jet L P491</b>	Beckton Minerva L278 LN	Beckton Lancer TS D390	ADG	<b>3.33</b>
		Beckton Minerva F495 CH	YR	<b>108</b>
	Beckton New Era Y194	Beckton Nebula P P707	Scr.	<b>39</b>
<b>Beckton Susan B246 N</b>	Beckton Susan R022 CQ	BKT Larkeisa T310 JC	Fr.	<b>5.0</b>
		Beckton Cherokee N N479		
		Beckton Susan N023 JE		

<b>DAM</b>	Calv.Ease	BW	WW	YW	Milk	HPG	Stay	Maint.En.
Age <b>5</b>	EPDs <b>22</b>	<b>-9.7</b>	<b>49</b>	<b>71</b>	<b>30</b>	<b>12</b>	<b>19</b>	<b>-2.0</b>
Wt <b>1040</b>	Acc. (.28)	(.62)	(.57)	(.57)	(.25)	(.11)	(.22)	(.21)
Wean Pct. <b>51%</b>								
Cow Eff. <b>106</b>	Marb <b>+.53</b> (.22)		REA <b>-.11</b> (.26)		Bfat <b>+.03</b> (.17)			

★★★★★ for Low Maintenance, Growth, Marbling, Calving Ease.

## J-6 Beckton Julian H023 E8

1-A 100% # 4378289 Tattoo: BSF0 H023

Birth: 2-18-20	Beckton Julian D551 C6	Beckton Julian X465 J5		Bwt <b>70</b>
		Beckton Tamara W550 A		WR <b>106</b>
<b>Beckton Julian F067 L7</b>	Beckton Indigo D786 L	Beckton Likable Z057 L4		ADG <b>4.43</b>
		Beckton Indigo Y026 N		YR <b>113</b>
	Beckton Epic B310 J6	Beckton Epic X464 L5		Scr. <b>36</b>
<b>Beckton Encino F334 E</b>	Beckton Encino B056 R	Beckton Minerva Y116 J		Fr. <b>6.0</b>
		Beckton Ranger Z225 J4		
		Beckton Encino Z782 D		

DAM	Calv.Ease	BW	WW	YW	Milk	HPG	Stay	Maint.En.
Age <b>2</b>	EPDs <b>18</b>	<b>-3.4</b>	<b>62</b>	<b>118</b>	<b>28</b>	<b>11</b>	<b>11</b>	<b>8.0</b>
Wt <b>830</b>	Acc. (.30)	(.46)	(.41)	(.41)	(.16)	(.05)	(.14)	(.09)
Wean Pct. <b>56%</b>	Marb <b>+.38</b> (.12)		REA <b>-.01</b> (.21)		Bfat <b>+.03</b> (.09)			
Cow Eff. <b>118</b>								

★★★★★ for Growth, Gainability, Marbling, High Cow Efficiency, Calving Ease.

## L-2 Beckton Likable C229 R3

1-A 100% # 3487279 Tattoo: BKT5 C229

Birth: 3-16-15	Beckton Likable S633	Beckton Lancer F442 T		Bwt <b>84</b>
		Beckton Kit F468 JL		WR <b>119</b>
<b>Beckton Likable U130 L2</b>	Beckton Kit S478 LN	Beckton Lancer F442 T		ADG <b>3.91</b>
		Beckton Kit F468 JL		YR <b>117</b>
	Beckton Roman J S158	TR Romeo NT379		Scr. <b>37</b>
<b>Beckton Tamara X447 J</b>	Beckton Tamara R834 JC	Beckton Belga K285 JL		Fr. <b>5.0</b>
		Beckton Justice CH M056		
		Beckton Tamara J229 NP		

DAM	Calv.Ease	BW	WW	YW	Milk	HPG	Stay	Maint.En.
Age <b>5</b>	EPDs <b>10</b>	<b>0.9</b>	<b>77</b>	<b>119</b>	<b>26</b>	<b>11</b>	<b>15</b>	<b>2.0</b>
Wt <b>1240</b>	Acc. (.45)	(.71)	(.65)	(.66)	(.34)	(.18)	(.32)	(.31)
Wean Pct. <b>57%</b>	Marb <b>+.37</b> (.29)		REA <b>+.42</b> (.36)		Bfat <b>+.03</b> (.23)			
Cow Eff. <b>120</b>								

★★★★★ for Growth, Gainability, Marbling, Rib-eye area, High Cow Efficiency.

## J-7 Beckton Julian H042 S8

1-A 100% # 4377525 Tattoo: BKT0 H042

Birth: 2-21-20	Beckton Julian D551 C6	Beckton Julian X465 J5		Bwt <b>72</b>
		Beckton Tamara W550 A		WR <b>112</b>
<b>Beckton Julian F067 L7</b>	Beckton Indigo D786 L	Beckton Likable Z057 L4		ADG <b>4.60</b>
		Beckton Indigo Y026 N		YR <b>121</b>
	Beckton Scamp B720 L4	Beckton Scamp X458 H3		Scr. <b>33</b>
<b>Beckton Indigo F643 S</b>	Beckton Indigo A849 N	Beckton Larkaba Y448 L		Fr. <b>6.0</b>
		Beckton Nebula T398 V3		
		Beckton Indigo U465 EP		

DAM	Calv.Ease	BW	WW	YW	Milk	HPG	Stay	Maint.En.
Age <b>2</b>	EPDs <b>21</b>	<b>-4.5</b>	<b>65</b>	<b>124</b>	<b>26</b>	<b>14</b>	<b>14</b>	<b>19.0</b>
Wt <b>820</b>	Acc. (.26)	(.47)	(.42)	(.39)	(.17)	(.01)	(.15)	(.09)
Wean Pct. <b>60%</b>	Marb <b>+.52</b> (.11)		REA <b>+.10</b> (.19)		Bfat <b>+.04</b> (.09)			
Cow Eff. <b>127</b>								

★★★★★ for Growth, Gainability, Marbling, High Cow Efficiency, Calving Ease.

## L-3 Beckton Likable E636 C3

1-A 100% # 3777515 Tattoo: BKB7 E636

Birth: 4-7-17	Beckton Likable S633	Beckton Lancer F442 T		Bwt <b>82</b>
		Beckton Kit F468 JL		WR <b>105</b>
<b>Beckton Likable U130 L2</b>	Beckton Kit S478 LN	Beckton Lancer F442 T		ADG <b>3.17</b>
		Beckton Kit F468 JL		YR <b>109</b>
	BKT Clifftop TP R288	Beckton Clifftop T C075		Scr. <b>33</b>
<b>Beckton Minola W808 C</b>	Beckton Minola R604 CD	Beckton Christy K209 CO		Fr. <b>5.0</b>
		Beckton Cody KH M390		
		Beckton Minola M310 CD		

DAM	Calv.Ease	BW	WW	YW	Milk	HPG	Stay	Maint.En.
Age <b>8</b>	EPDs <b>14</b>	<b>-2.0</b>	<b>60</b>	<b>93</b>	<b>27</b>	<b>13</b>	<b>15</b>	<b>-3.0</b>
Wt <b>1240</b>	Acc. (.28)	(.40)	(.37)	(.38)	(.28)	(.10)	(.24)	(.23)
Wean Pct. <b>47%</b>	Marb <b>+.26</b> (.18)		REA <b>+.38</b> (.23)		Bfat <b>+.03</b> (.14)			
Cow Eff. <b>100</b>								

★★★★★ for Low Maintenance, Growth, Marbling, Rib-eye area, Calving Ease.

## L-1 Beckton Likable B032 C5

1-A 100% # 1705725 Tattoo: BKB4 B032

Birth: 2-17-14	Beckton Likable X445 J3	Beckton Likable U130 L2		Bwt <b>63</b>
		Beckton Indigo U658 JL		WR <b>110</b>
<b>Beckton Likable Z057 L4</b>	Beckton Minola X107 L	Beckton Likable U120 L2		ADG <b>4.72</b>
		Beckton Minola U188 NB		YR <b>119</b>
	Beckton Clifftop W577 E3	BKT Clifftop TP R288		Scr. <b>35</b>
<b>Beckton Mona Z270 C</b>	Beckton Mona U584 CD	BKT Pine Marie R213 EP		Fr. <b>6.0</b>
		Beckton Cody K2 R168		
		Beckton Mona P539 CH		

DAM	Calv.Ease	BW	WW	YW	Milk	HPG	Stay	Maint.En.
Age <b>2</b>	EPDs <b>18</b>	<b>-5.7</b>	<b>52</b>	<b>110</b>	<b>21</b>	<b>15</b>	<b>13</b>	<b>17.0</b>
Wt <b>884</b>	Acc. (.56)	(.76)	(.72)	(.73)	(.50)	(.28)	(.34)	(.36)
Wean Pct. <b>50%</b>	Marb <b>+.58</b> (.35)		REA <b>-.04</b> (.42)		Bfat <b>+.03</b> (.25)			
Cow Eff. <b>106</b>								

★★★★★ for Growth, Gainability, Marbling, Calving Ease.



Beckton Likeable B032 (L-1)

## L-4 Beckton Likable F287 J6

1-A 100% # 3987766 Tattoo: BKT8 F287

Birth: 3-16-18

- Beckton Likable Z057 L4
  - Beckton Likable X445 J3
  - Beckton Minola X107 L
- Beckton Likable B032 C5**
  - Beckton Clifftop W577 E3
  - Beckton Mona U584 CD
- Beckton Mona Z270 C
  - Beckton Julian G1 J526
  - Beckton Rose L311 LN
- Beckton Larkaba X064 J**
  - BKT Clifftop TP R288
  - Beckton Larkaba R809 NB
- Beckton Julian U699 L5
- Beckton Larkaba U475 CT

<b>DAM</b>	Calv.Ease	BW	WW	YW	Milk	HPG	Stay	Maint.En.
Age <b>8</b>	EPDs <b>18</b>	<b>-5.7</b>	<b>61</b>	<b>109</b>	<b>22</b>	<b>15</b>	<b>17</b>	<b>6.0</b>
Wt <b>915</b>	Acc. (.35)	(.64)	(.59)	(.58)	(.26)	(.14)	(.21)	(.22)
Wean Pct. <b>60%</b>	Marb <b>+0.55</b> (.19)		REA <b>-0.09</b> (.28)		Bfat <b>+0.06</b> (.14)			
Cow Eff. <b>126</b>								

★★★★★ for Growth, Gainability, Marbling, High Cow Efficiency, Calving Ease.

## L-7 Beckton Likable H518 N5

1-A 100% # 4376971 Tattoo: BKT0 H518

Birth: 4-4-20

- Beckton Likable Y124 L3
  - Beckton Likable U130 L2
  - BKT Pine Marie S802 L0
- Beckton Likable E391 N4**
  - Beckton Nebula T398 V3
  - Beckton Lana T226 NB
- Beckton Lana X466 N
  - Beckton Nebula L P093
  - Beckton Minerva J615 VG
- Beckton Serena X338 N**
  - Beckton Loki C M740
  - Beckton Serena F248 CZ
- Beckton Nebula T398 V3
- Beckton Serena S649 L0

<b>DAM</b>	Calv.Ease	BW	WW	YW	Milk	HPG	Stay	Maint.En.
Age <b>10</b>	EPDs <b>11</b>	<b>0.0</b>	<b>73</b>	<b>114</b>	<b>25</b>	<b>12</b>	<b>21</b>	<b>4.0</b>
Wt <b>1180</b>	Acc. (.26)	(.49)	(.43)	(.45)	(.22)	(.07)	(.17)	(.14)
Wean Pct. <b>52%</b>	Marb <b>+0.46</b> (.14)		REA <b>+0.01</b> (.22)		Bfat <b>+0.04</b> (.09)			
Cow Eff. <b>109</b>								

★★★★★ for Growth, Gainability, Marbling.

## L-5 Beckton Likable G289 J5

1-A 100% # 4170516 Tattoo: BKT9 G289

Birth: 3-20-19

- Beckton Likable X445 J3
  - Beckton Likable U130 L2
  - Beckton Indigo U658 JL
- Beckton Likable Z057 L4**
  - Beckton Likable U120 L2
  - Beckton Minola U188 NB
- Beckton Minola X107 L
  - Beckton Julian 7526G
  - Bkt Marta 9A13 JL
- Beckton Coca B785 J**
  - Beckton Nebula T398 V3
  - Beckton Coca P602 JL
- Beckton Julian GG B571
- Beckton Coca X787 N

<b>DAM</b>	Calv.Ease	BW	WW	YW	Milk	HPG	Stay	Maint.En.
Age <b>5</b>	EPDs <b>14</b>	<b>-4.1</b>	<b>57</b>	<b>97</b>	<b>26</b>	<b>15</b>	<b>16</b>	<b>-1.0</b>
Wt <b>985</b>	Acc. (.34)	(.55)	(.52)	(.53)	(.30)	(.07)	(.27)	(.23)
Wean Pct. <b>56%</b>	Marb <b>+0.48</b> (.24)		REA <b>+0.09</b> (.31)		Bfat <b>+0.03</b> (.20)			
Cow Eff. <b>118</b>								

★★★★★ for Low Maintenance, Growth, Gainability, Marbling, High Cow Efficiency, Calving Ease.

## N-1 Beckton New Era Y194

1-A 100% # 1451309 Tattoo: BKB1 Y194

Birth: 3-20-11

- Beckton Nebula M045
  - Beckton Neptune R2 K065
  - Beckton Belga K285 JL
- Beckton Nebula P P707**
  - Beckton Epic K1 K863
  - Beckton Lana K253 DM
- Beckton Lana M809 EP
  - Beckton Justice CH M056
  - Beckton Tamara J124 HR
- BKT Larkeisa T310 JC**
  - Beckton Justice C K449
  - BKT Larkeisa L149 CK
- Beckton Justice C1 R483
- BKT Larkeisa R775 JC

<b>DAM</b>	Calv.Ease	BW	WW	YW	Milk	HPG	Stay	Maint.En.
Age <b>4</b>	EPDs <b>15</b>	<b>-3.3</b>	<b>60</b>	<b>97</b>	<b>28</b>	<b>14</b>	<b>20</b>	<b>1.0</b>
Wt <b>950</b>	Acc. (.70)	(.85)	(.81)	(.83)	(.70)	(.67)	(.56)	(.53)
Wean Pct. <b>82%</b>	Marb <b>+0.36</b> (.59)		REA <b>-0.13</b> (.59)		Bfat <b>+0.03</b> (.45)			
Cow Eff. <b>174</b>								

★★★★★ for Growth, Gainability, Marbling, High Cow Efficiency, Calving Ease.

## L-6 Beckton Likable G403 N4

1-A 100% # 4170280 Tattoo: BKT9 G403

Birth: 3-26-19

- Beckton Likable U130 L2
  - Beckton Likable S633
  - Beckton Kit S478 LN
- Beckton Likable C229 R3**
  - Beckton Roman J S158
  - Beckton Tamara R834 JC
- Beckton Tamara X447 J
  - Beckton Nebula L P093
  - Beckton Minerva J615 VG
- Beckton Minerva Y385 N**
  - Beckton Loki CL S284
  - Beckton Minerva S283 HU
- Beckton Nebula T398 V3
- Beckton Minerva U310 LO

<b>DAM</b>	Calv.Ease	BW	WW	YW	Milk	HPG	Stay	Maint.En.
Age <b>8</b>	EPDs <b>20</b>	<b>-7.8</b>	<b>55</b>	<b>89</b>	<b>28</b>	<b>9</b>	<b>21</b>	<b>-3.0</b>
Wt <b>1050</b>	Acc. (.27)	(.59)	(.54)	(.52)	(.21)	(.07)	(.19)	(.16)
Wean Pct. <b>58%</b>	Marb <b>+0.30</b> (.17)		REA <b>+0.14</b> (.24)		Bfat <b>+0.04</b> (.12)			
Cow Eff. <b>122</b>								

★★★★★ for Low Maintenance, Growth, Gainability, Marbling, Rib-eye area, High Cow Efficiency, Calving Ease.



Beckton New Era Y194 (N-1)

## N-2 Beckton Nebula A773 L4

1-A 100% # 1625980 Tattoo: BKB3 A773

Birth: 4-13-13

- Beckton Nebula L P093 < Beckton Nebula M045
- Beckton Nebula T398 V3 < Beckton Marta M021 LN
- Beckton Minerva J615 VG < Beckton Vegas PK F485
- Beckton Likable U130 L2 < Beckton Minerva F433 VG
- Beckton Likable U130 L2 < Beckton Likable S633
- Beckton Kit S478 LN < Beckton Kit S478 LN
- Beckton Cody K2 R168 < Beckton Cody K2 R168
- Beckton Mona U584 CD < Beckton Mona P539 CH

BWT	66	WR	118	ADG	3.54	YR	109	Scr.	36	Fr.	5.5
-----	----	----	-----	-----	------	----	-----	------	----	-----	-----

DAM		Calv.Ease	BW	WW	YW	Milk	HPG	Stay	Maint.En.	
Age	3	EPDs	12	-2.5	65	100	30	14	27	4.0
Wt	955	Acc.	(.44)	(.72)	(.68)	(.69)	(.41)	(.11)	(.31)	(.31)
Wean Pct.	61%	Marb	+.30 (.26)		REA	+.01 (.36)		Bfat	+.04 (.17)	
Cow Eff.	128									

★★★★★ for Growth, Gainability, Marbling, High Cow Efficiency, Calving Ease.

## N-5 Beckton Nebula H566 L5

1-A 100% # 4376917 Tattoo: BKT0 H566

Birth: 4-7-20

- Beckton Nebula T398 V3 < Beckton Nebula L P093
- Beckton Minerva J615 VG < Beckton Minerva J615 VG
- Beckton Likable U130 L2 < Beckton Likable U130 L2
- Beckton Mona X022 L < Beckton Mona U584 CD
- Beckton Likable U120 L2 < Beckton Likable U120 L2
- Beckton Lana N869 LO < Beckton Lana N869 LO
- Beckton Clifftop Y012 C4 < Beckton Clifftop Y012 C4
- Beckton Maiaata A091 C < Beckton Maiaata Y266 J

BWT	78	WR	110	ADG	4.16	YR	113	Scr.	39	Fr.	5.5
-----	----	----	-----	-----	------	----	-----	------	----	-----	-----

DAM		Calv.Ease	BW	WW	YW	Milk	HPG	Stay	Maint.En.	
Age	5	EPDs	14	-2.3	61	100	33	11	21	10.0
Wt	1180	Acc.	(.23)	(.46)	(.40)	(.42)	(.20)	(.03)	(.18)	(.15)
Wean Pct.	50%	Marb	+.39 (.14)		REA	+.05 (.20)		Bfat	+.03 (.09)	
Cow Eff.	105									

★★★★★ for Growth, Gainability, Marbling, Calving Ease.

## N-3 Beckton Nebula F440 H4

1-A 100% # 3988546 Tattoo: BSF8 F440

Birth: 3-23-18

- Beckton Nebula P P707 < Beckton Nebula M045
- Beckton Lana M809 EP < Beckton Lana M809 EP
- Beckton Justice CH M056 < Beckton Justice CH M056
- Beckton Larkaba T813 JC < Beckton Larkaba P645 JL
- Beckton Hasten H S462 < Beckton Hasten P292
- Beckton Lakme G128 HD < Beckton Lakme G128 HD
- Beckton Julian G1 J526 < Beckton Julian G1 J526
- Beckton Minola N751 JL < Beckton Minola J091 JL

BWT	84	WR	116	ADG	3.28	YR	116	Scr.	37	Fr.	5.5
-----	----	----	-----	-----	------	----	-----	------	----	-----	-----

DAM		Calv.Ease	BW	WW	YW	Milk	HPG	Stay	Maint.En.	
Age	8	EPDs	14	-3.8	58	91	25	13	16	2.0
Wt	1140	Acc.	(.36)	(.63)	(.58)	(.56)	(.26)	(.07)	(.23)	(.20)
Wean Pct.	55%	Marb	+.52 (.19)		REA	-.19 (.29)		Bfat	+.04 (.15)	
Cow Eff.	115									

★★★★★ for Growth, Marbling, Calving Ease.

## O-1 Redhill 9B Lancer 11E

1-A 100% # 3627551 Tattoo: NA

Birth: 1-3-17

- Buf Crk The Right Kind U199 < Buf Crk Lancer R017
- Buf Crk Shoshone R353 < Buf Crk Shoshone R353
- Beckton Julian GG B571 < Beckton Julian GG B571
- MRM 832 8664 9005 < MRM 832 8664 9005
- Buf Crk Nice'N Easy T189 < Buf Crk Medallion N328
- Buf Crk Redpride P154 < Buf Crk Redpride P154
- BFCk Cherokee Cnyn 4912 < BFCk Cherokee Cnyn 4912
- Beckton Barmaid M554 CH < Beckton Barmaid M554 CH

BWT	85	WR	NA	ADG	NA	YR	NA	Scr.	NA	Fr.	NA
-----	----	----	----	-----	----	----	----	------	----	-----	----

DAM		Calv.Ease	BW	WW	YW	Milk	HPG	Stay	Maint.En.	
Age	8	EPDs	8	-0.8	70	106	29	16	13	14.0
Wt	NA	Acc.	(.55)	(.60)	(.57)	(.57)	(.31)	(.34)	(.40)	(.23)
Wean Pct.	NA%	Marb	+.51 (.42)		REA	-.20 (.44)		Bfat	+.03 (.37)	
Cow Eff.	NA									

★★★★★ for Marbling.

## N-4 Beckton Nebula G249 N4

1-A 100% # 4171298 Tattoo: BSF9 G249

Birth: 3-18-19

- Beckton Nebula P P707 < Beckton Nebula M045
- Beckton Lana M809 EP < Beckton Lana M809 EP
- Beckton Justice CH M056 < Beckton Justice CH M056
- Beckton Larkaba T813 JC < Beckton Larkaba P645 JL
- Beckton Nebula W022 D3 < Beckton Nebula T269 E2
- Beckton Eola T070 DM < Beckton Eola T070 DM
- Beckton Dominor Z1 R610 < Beckton Dominor Z1 R610
- Beckton Lana W525 D < Beckton Lana S520 JO

BWT	75	WR	121	ADG	4.02	YR	120	Scr.	38	Fr.	5.5
-----	----	----	-----	-----	------	----	-----	------	----	-----	-----

DAM		Calv.Ease	BW	WW	YW	Milk	HPG	Stay	Maint.En.	
Age	8	EPDs	16	-4.9	49	91	30	14	17	7.0
Wt	1120	Acc.	(.31)	(.60)	(.57)	(.55)	(.24)	(.07)	(.21)	(.18)
Wean Pct.	55%	Marb	+.58 (.18)		REA	-.13 (.26)		Bfat	+.04 (.13)	
Cow Eff.	115									

★★★★★ for Growth, Gainability, Marbling, Calving Ease.

## O-2 Schuler Oracle-7142E

1-A 100% # 3778379 Tattoo: NA

Birth: 3-10-17

- Red Crowfoot Ole's Oscar < Mlk Crk Cub 722
- Red Crowfoot Omega 9179J < Red Crowfoot Omega 9179J
- Basin Trend Setter 6074 < Basin Trend Setter 6074
- SOR Duchess TS 8915U < SOR Duchess BC 4425P
- LJC Lancer 806 < LJC Lancer 806
- Brown MS Shazzam P7940 < Brown MS Shazzam P7940
- Lonerock Beefstake 0024 < Lonerock Beefstake 0024
- Sor Marlee Bur 0019K < Sor Marlee Bur 0019K

BWT	76	WR	98	ADG	NA	YR	98	Scr.	37	Fr.	5.5
-----	----	----	----	-----	----	----	----	------	----	-----	-----

DAM		Calv.Ease	BW	WW	YW	Milk	HPG	Stay	Maint.En.	
Age	5	EPDs	19	-4.3	59	109	21	10	16	5.0
Wt	NA	Acc.	(.40)	(.74)	(.70)	(.70)	(.33)	(.22)	(.25)	(.26)
Wean Pct.	NA%	Marb	+.90 (.26)		REA	+.33 (.34)		Bfat	+.02 (.23)	
Cow Eff.	NA									

★★★★★ for Marbling, Rib-eye area, Calving Ease.

### 0-3 LSF SRR President 8177F

1-A 100% # 3925037 Tattoo: NA

Birth: 2-16-18

LSF SRR Commander 5906C

LSF SRR Flo-Marie 961 D6451

HXC Conquest 4405P  
LSF Crystal R5145 X0414  
Messmer Packer S008  
LSF Della P4078 U8051

Beckton Julian GG B571  
HXC Ellie May MA638  
Messmer Packer S008  
LSF Crystal LA394 R5145  
Messmer Joshua 019P  
Messmer Millie 124P  
Feddes Big Sky R9  
LSF Della G1372 P4078

BWt	67
WR	103
ADG	NA
YR	106
Scr.	NA
Fr.	NA

DAM		Calv.Ease	BW	WW	YW	Milk	HPG	Stay	Maint.En.	
Age	2	EPDs	15	-4.8	72	106	32	17	19	-9.0
Wt	NA	Acc.	(.71)	(.86)	(.83)	(.83)	(.27)	(.46)	(.27)	(.35)
Wean Pct.	NA%	Marb	+.91 (.50)		REA	+.33 (.44)		Bfat	+.03 (.37)	
Cow Eff.	NA									

### R-1 Beckton Ranger G299 N6

1-A 100% # 4170624 Tattoo: BKT9 G299

Birth: 3-20-19

Beckton Ranger B006 D5

Beckton Indigo C018 N

Beckton Ranger Z225 J4  
Beckton Suffeina Z731 D  
Beckton Nebula A773 L4  
Beckton Indigo A849 N

Beckton Ranger T603 H3  
Beckton Mona U564 JT  
Beckton Dominor W640 C5  
Beckton Suffeina W471 W  
Beckton Nebula T398 V3  
Beckton Mona X022 L  
Beckton Nebula T398 V3  
Beckton Indigo U465 EP

BWt	74
WR	106
ADG	3.98
YR	109
Scr.	36
Fr.	5.5

DAM		Calv.Ease	BW	WW	YW	Milk	HPG	Stay	Maint.En.	
Age	4	EPDs	18	-4.8	58	101	30	10	17	2.0
Wt	1030	Acc.	(.26)	(.55)	(.53)	(.52)	(.23)	(.02)	(.19)	(.19)
Wean Pct.	50%	Marb	+.47 (.14)		REA	+.04 (.26)		Bfat	+.05 (.10)	
Cow Eff.	105									

★★★★★ for Low Maintenance, Growth, Marbling, Rib-eye area, Calving Ease.

★★★★★ for Growth, Gainability, Marbling, Calving Ease.

### 0-4 Beckton Oracle G222 J2

1-A 100% # 4170878 Tattoo: BKT9 G222

Birth: 3-16-19

Schuler Oracle-7142E

Beckton Rose E470 J

Schuler Sudden Impact 0004X  
Sor Marlee Cmmmtnt 0470X  
Beckton Julian GG B571  
Beckton Rose W346 E

Red Crowfoot Ole's Oscar  
SOR Duchess TS 8915U  
Brown Commitment S7206  
SOR Marlee Beef 4511P  
Beckton Julian 7526G  
Bkt Marta 9A13 JL  
Beckton Emcee S466  
Beckton Rose L083 LN

BWt	59
WR	121
ADG	3.28
YR	114
Scr.	33
Fr.	5.0

DAM		Calv.Ease	BW	WW	YW	Milk	HPG	Stay	Maint.En.	
Age	2	EPDs	23	-8.1	55	92	26	12	15	6.0
Wt	770	Acc.	(.33)	(.59)	(.55)	(.55)	(.20)	(.11)	(.22)	(.16)
Wean Pct.	59%	Marb	+.72 (.17)		REA	+.15 (.27)		Bfat	+.04 (.14)	
Cow Eff.	124									

★★★★★ for Growth, Marbling, Rib-eye area, High Cow Efficiency, Calving Ease.

### S-1 Beckton Scamp E175 N5

1-A 100% # 3776509 Tattoo: BKT7 E175

Birth: 3-7-17

Beckton Scamp B720 L4

Beckton Belga W103 N

Beckton Scamp X458 H3  
Beckton Larkaba Y448 L  
Beckton Nebula T398 V3  
Beckton Belga T551 EP

Beckton Scamp T A825  
BKT Pine Marie R401 HU  
Beckton Likable U130 L2  
Beckton Larkaba T655 NB  
Beckton Nebula L P093  
Beckton Minerva J615 VG  
Beckton Epic K3 M606  
Beckton Belga K285 JL

BWt	78
WR	106
ADG	4.06
YR	114
Scr.	41
Fr.	5.5

DAM		Calv.Ease	BW	WW	YW	Milk	HPG	Stay	Maint.En.	
Age	8	EPDs	20	-6.6	50	93	27	9	16	9.0
Wt	1015	Acc.	(.45)	(.75)	(.72)	(.72)	(.34)	(.06)	(.24)	(.29)
Wean Pct.	55%	Marb	+.45 (.27)		REA	-.02 (.35)		Bfat	+.03 (.20)	
Cow Eff.	116									

★★★★★ for Growth, Gainability, Marbling, High Cow Efficiency, Calving Ease.

### 0-5 Beckton Oracle H390 L2

1-A 100% # 4377111 Tattoo: BKT0 H390

Birth: 3-27-20

Schuler Oracle-7142E

Beckton Lana D222 L

Schuler Sudden Impact 0004X  
Sor Marlee Cmmmtnt 0470X  
Beckton Legend S670  
Beckton Lana T348 NB

Red Crowfoot Ole's Oscar  
SOR Duchess TS 8915U  
Brown Commitment S7206  
SOR Marlee Beef 4511P  
Beckton Lancer F442 T  
Beckton Kit F468 JL  
Beckton Nebula E P084  
Beckton Lana M167 LN

BWt	75
WR	110
ADG	3.89
YR	116
Scr.	38
Fr.	5.5

DAM		Calv.Ease	BW	WW	YW	Milk	HPG	Stay	Maint.En.	
Age	4	EPDs	16	-1.8	74	128	25	11	18	10.0
Wt	1025	Acc.	(.22)	(.45)	(.42)	(.43)	(.18)	(.07)	(.16)	(.16)
Wean Pct.	55%	Marb	+.60 (.14)		REA	+.33 (.21)		Bfat	+.03 (.11)	
Cow Eff.	116									

★★★★★ for Growth, Gainability, Marbling, Rib-eye area, High Cow Efficiency, Calving Ease.

### S-2 Beckton Scamp G006 C6

1-A 100% # 4171814 Tattoo: BSF9 G006

Birth: 2-12-19

Beckton Scamp E175 N5

Beckton Firefly E769 C

Beckton Scamp B720 L4  
Beckton Belga W103 N  
Beckton Cardinal B074 N  
Beckton Firefly B052 W

Beckton Scamp X458 H3  
Beckton Larkaba Y448 L  
Beckton Nebula T398 V3  
Beckton Belga T551 EP  
TR Double Eagle ZT220  
BKT Pine Marie Z250 N  
Beckton Warrior Z936 N6  
Beckton Firefly Z663 N

BWt	54
WR	110
ADG	4.36
YR	122
Scr.	36
Fr.	5.5

DAM		Calv.Ease	BW	WW	YW	Milk	HPG	Stay	Maint.En.	
Age	2	EPDs	22	-9.1	49	97	29	10	17	10.0
Wt	720	Acc.	(.28)	(.56)	(.52)	(.50)	(.19)	(.02)	(.13)	(.14)
Wean Pct.	60%	Marb	+.40 (.15)		REA	-.02 (.21)		Bfat	+.03 (.12)	
Cow Eff.	126									

★★★★★ for Growth, Gainability, Marbling, High Cow Efficiency, Calving Ease.



# Reference Sire Lot Index

Lot	ID	Lot	ID	Lot	ID	Lot	ID	Lot	ID	Lot	ID	Lot	ID
<b>Accent F895 (A)</b>		<b>Cardinal E673 (C-1)</b>		<b>Epic H312 (E-2)</b>		<b>Legend E464 (L)</b>		<b>New Era Y194 (N-1)</b>		<b>President FL177 (O-3)</b>		<b>Scamp G006 (S-2)</b>	
231	.....K663	30	.....K266	35	.....K182	55	.....K496	5	.....K561	194	.....K412	43	.....K191
<b>Accent W180 (A-1)</b>		34	.....K446	41	.....K233	<b>Likable B032 (L-1)</b>		6	.....K726	<b>Oracle G222 (O-4)</b>		74	.....K213
36	.....K512	52	.....K636	87	.....K087	23	.....KC201	220	.....K468	38	.....K382	158	.....K575
71	.....K705	54	.....K532	<b>Epic H335 (E-3)</b>		135	.....KC206	232	.....K644	61	.....K378	314	.....K433(H)
<b>Accent B549 (A-2)</b>		67	.....K721	149	.....K079	191	.....KC204	<b>Nebula A773 (N-2)</b>		112	.....K653	<b>Scamp G236 (S-3)</b>	
28	.....K400	81	.....K235	328	..K026(H)	205	.....KC205	25	.....K421	224	.....K331	8	.....K188
116	.....K841	86	.....K609	<b>Heritage F615 (H-1)</b>		<b>Likable C229 (L-2)</b>		32	.....K360	<b>Oracle H390 (O-5)</b>		14	.....K698
151	.....K953	108	.....K313	78	.....K539	24	.....K505	76	.....K633	53	.....K126	82	.....K285
214	.....K864	128	.....K733	<b>Heritage H181 (H-2)</b>		27	.....K673	94	.....K848	57	.....K067	85	.....K741
309	..K332(H)	190	.....K610	97	.....K002	56	.....K767	142	.....K855	80	.....K172	96	.....K702
<b>Accent B740 (A-3)</b>		<b>Cardinal G043 (C-2)</b>		136	.....K205	95	.....K674	162	.....K656	179	.....K406	103	.....K458
26	.....K490	18	.....K396	138	.....K068	121	.....K826	166	.....K775	<b>Ranger G299 (R-1)</b>		118	.....K299
107	.....K650	125	.....K279	170	.....K055	217	.....K671	<b>Nebula F440 (N-3)</b>		9	.....K404	132	.....K516
182	.....K866	<b>Cardinal H671 (C-3)</b>		<b>Julian B571 (J-1)</b>		311	..K425(H)	119	.....K497	11	.....K361	206	.....K871
195	.....K683	59	.....K101	83	.....K460	312	..K484(H)	189	.....K823	75	.....K363	208	.....K365
236	.....K419	131	.....K098	<b>Julian Z382 (J-2)</b>		<b>Likable E636 (L-3)</b>		305	..K380(H)	176	.....K163	225	.....K383
316	..K559(H)	<b>Dominor D254 (D)</b>		140	.....K529	63	.....K839	319	..K234(H)	213	.....K275	301	..K158(H)
<b>Accent F602 (A-4)</b>		321	..K195(H)	<b>Julian E423 (J-3)</b>		73	.....K343	323	..K596(H)	<b>Scamp G325 (S)</b>		325	..K635(H)
4	.....K324	<b>Dominor F263 (D-1)</b>		203	.....K923	90	.....K723	<b>Nebula G249 (N-4)</b>		302	..K326(H)	<b>Scamp H076 (S-4)</b>	
29	.....K456	15	.....K322	<b>Julian F067 (J-4)</b>		181	.....K786	1	.....K302	<b>Scamp H215 (S)</b>		37	.....K124
126	.....K588	44	.....K509	12	.....K838	218	.....K634	10	.....K295	146	.....K242	84	.....K082
130	.....K629	88	.....K688	51	.....K440	230	.....K728	46	.....K583	<b>Scamp H356 (S)</b>		98	.....K095
172	.....K670	91	.....K466	60	.....K773	313	..K722(H)	62	.....K475	100	.....K152	154	.....K181
197	.....K837	148	.....K574	143	.....K410	<b>Likable F287 (L-4)</b>		64	.....K444	<b>Scamp E175 (S-1)</b>		185	.....K113
228	.....K599	155	.....K570	160	.....K840	31	.....K176	65	.....K429	33	.....K246	196	.....K131
<b>Accent G107 (A-5)</b>		156	.....K432	193	.....K576	49	.....K667	183	.....K681	39	.....K202	<b>Warrior G356 (W-1)</b>	
66	.....K338	171	.....K550	216	.....K761	92	.....K329	229	.....K271	68	.....K143	13	.....K108
104	.....K455	175	.....K564	322	..K655(H)	115	.....K232	238	.....K327	72	.....K241	16	.....K320
144	.....K815	209	.....K354	<b>Jet G441 (J-5)</b>		173	.....K684	<b>Nebula H566 (N-5)</b>		77	.....K508	42	.....K778
187	.....K525	327	..K228(H)	7	.....K247	240	.....K244	137	.....K178	89	.....K804	47	.....K782
192	.....K714	<b>Dominor G402 (D-2)</b>		58	.....K431	303	..K222(H)	150	.....K660	109	.....K225	93	.....K737
<b>Accent G208 (A-6)</b>		124	.....K604	153	.....K651	308	..K211(H)	221	.....K122	111	.....K148	99	.....K405
114	.....K391	<b>Dominor H382 (D-3)</b>		169	.....K358	310	..K282(H)	<b>Oracle H376 (O)</b>		133	.....K206	163	.....K784
201	.....K549	129	.....K051	199	.....K305	<b>Likable G289 (L-5)</b>		45	.....K130	145	.....K238	177	.....K317
<b>Accent H059 (A-7)</b>		165	.....K029	204	.....K585	3	.....K250	<b>Oracle H725 (O)</b>		157	.....K300	200	.....K619
141	.....K133	223	.....K212	211	.....K572	48	.....K284	168	.....K099	159	.....K252	219	.....K473
234	.....K274	331	..K115(H)	226	.....K488	233	.....K491	<b>RH Lancer ERH11 (O-1)</b>		212	.....K863	239	.....K486
<b>Accent H121 (A-8)</b>		<b>Dominor H423 (D-4)</b>		<b>Julian H023 (J-6)</b>		315	..K507(H)	70	.....K472	215	.....K223	324	..K494(H)
21	.....K186	69	.....KC215	184	.....K116	<b>Likable G403 (L-6)</b>		174	.....K445	222	.....K766		
139	.....K309	117	.....KC192	188	.....K073	2	.....K294	198	.....K577	227	.....K821		
<b>Accent H410 (A-9)</b>		237	..KC209	<b>Julian H042 (J-7)</b>		50	.....K379	<b>Oracle ES142 (O-2)</b>		307	..K342(H)		
20	.....K469	<b>Epic B545 (E)</b>		19	.....K154	106	.....K367	79	.....K467	309	..K332(H)		
123	.....K132	329	..K413(H)	102	.....K070	147	.....K771	105	.....K621	318	..K226(H)		
152	.....K435	<b>Epic G227 (E-1)</b>		120	.....K137	<b>Likable H518 (L-7)</b>		110	.....K197	320	..K357(H)		
<b>Hughes F076 (B-1)</b>		122	.....K676	<b>Likable F520 (L)</b>		22	.....K114	161	.....K641	326	..K675(H)		
17	.....K824	127	.....K595	40	.....K443	101	.....K145	164	.....K170	330	..K763(H)		
178	.....K441	134	.....K770	317	..K554(H)	<b>Legend E464 (L)</b>		180	.....K283	332	..K214(H)		
304	..K535(H)					<b>Legend E464 (L)</b>		202	.....K880				



# Sale Terms and Conditions

Except for those stated in the terms and conditions below, there are no warranties, either expressed or implied, as to the merchantability or fitness for a particular purpose with respect to the cattle being sold at this auction. The warranties and guarantees set forth in the "Terms and Conditions" are in lieu of all other warranties, either expressed or implied, and the remedies provided therein shall be the sole and exclusive remedy for the Buyer, or any party claiming through Buyer, for any breach of warranty or guarantee therein provided, and all other obligations or liabilities.

The information in the catalog is believed to be accurate, and the information seller believes to be most representative. It is the nature of seller's business that the seller engages in a continual process of collecting new data and information. Therefore, any information presented at the time of sale is always subject to revision, correction or update.

## I. BIDDING

The Auctioneer in charge will settle any disputes as to bids, and his decision on such matters shall be final.

## II. TERMS

Terms of sale are cash or personal check unless satisfactory credit arrangements have been made with vendor prior to sale.

## III. PURCHASER'S RISK

Each animal becomes the risk of the purchaser as soon as sold, but it shall be the obligation of the Seller to see that animals are fed and cared for free of charge to purchaser, until loaded for shipment or until the expiration of 48 hours after the sale, whichever occurs sooner.

## IV. DELIVERY

For any animals for which seller's arrange delivery, the following terms shall apply. Each animal becomes the risk of the purchaser as soon as sold, and through the time of delivery. The seller will arrange transportation and delivery schedules, and may combine animals from one or more purchasers for convenience and to reduce costs. If delivery is arranged, seller assumes no other liability. Once the purchaser has been notified of the date and approximate time of delivery (morning, afternoon, evening, etc.), it is the responsibility of the purchaser to arrange adequate and agreeable location and facilities for unloading each animal. When unloaded at the agreed upon location, all care and management of the animal is the responsibility of the purchaser.

## V. CERTIFICATE OF REGISTRY

A transferred certificate of registry will be furnished to the purchaser for each animal for which a Registration number is listed.

## VI. HEALTH

All animals are eligible for interstate shipment, except as otherwise announced. Interstate health papers will be furnished for each animal requiring T.B, Bang's, and trich tests in accordance with federal and state regulations.

## VII. DIVISIBILITY

The percentage of ownership interest received by the buyer, whether it is 100% or 2/3 or otherwise as defined in the catalog or by the auctioneer, may not be subsequently divided without the express written consent of the seller.

## VIII. ANNOUNCEMENTS

Any changes from information of any kind in this catalog will be announced from the auction box and such announcements shall take precedence.

## IX. BREEDING GUARANTEE

Any female that has had a calf prior to the date of sale shall be considered a breeder without further guarantee. All females sold as 'bred' or 'pregnant' have been pregnancy checked by a licensed veterinarian and are guaranteed bred on the day of sale. The purchaser may elect to have any female so listed rechecked at their cost within 30 days of delivery by a licensed veterinarian of their choice. Any such female determined open by this recheck may be returned to the seller for a full refund. Due to conditions out of seller's control, once a female leaves seller's possession, this is the only guarantee offered.

All bulls are sold as guaranteed breeders. Each bull has been officially fertility tested as "Satisfactory Breeder" prior to the sale. However, seller cannot guarantee against physical injury or illness following the sale. But if within 8 months following the sale, the buyer has evidence that the animal is not a breeder, the buyer may obtain a statement signed by a licensed veterinarian to that effect, such statement also indicating that there has been no injury or illness to the animal following the sale, and return the bull to the farm of the seller for adjustment. If the seller cannot then prove the animal to be a breeder, an adjustment will be made by the seller, either by substituting an animal of equal value, or by the refund of the full purchase price. Such adjustment shall be considered full settlement and satisfaction of all claims. No guarantees apply to animals which are shown following the sale.

## X. GENETIC DEFECT GUARANTEE AND PARENTAGE

All parentage and pedigrees presented in the catalog are believed accurate based upon the breeding and DNA information we have available. However, parentage and pedigree information cannot be guaranteed 100%, because it is always possible that new information or new DNA technology and testing might show that there have been inadvertent errors.

Osteopetrosis: The Red Angus Association along with animal scientists have developed a DNA marker test for osteopetrosis (OS), a genetic disorder which in rare instances can cause the loss of a calf at birth. Since the test was developed, Beckton has tested every sire being used in our breeding program. Only one sire, from outside our program, tested positive as a carrier of the gene. Every sire bred and raised at Beckton has tested 'Free'. All of our major semen sires have also been tested 'Free'. We guarantee every sale animal to be OS Free, and if you have a concern, we will have any sale animal tested on request. If an animal were to test positive, we would replace the animal or refund the purchase price. The testing we have done shows no incidence of occurrence in any Beckton bloodlines for the past 30 years, and so we believe there is no safer herd than ours.

## XI. RETAINED INTEREST AND SEMEN RIGHTS:

Beckton is selling full possession and one half semen interest in all the bulls in the catalog. Seller is retaining one half interest in all bulls in the catalog. This is done so we can use some of the bulls in herd and reserve the right to collect and market semen on these bulls. Any collection on our behalf would be at our expense and could be done during the off-season and at the convenience of the buyer. The buyer would have the option to share in the collection and retain semen for the buyer's use also. If semen is marketed by either party, Seller receives one half royalty interest on gross semen sales, and buyer receives one half interest. Regardless of semen collection and marketing, the buyer retains full possession, full pasture use rights, and full salvage value in these bulls.

## XII. RIGHTS AND OBLIGATIONS

A. The above terms and conditions of sale shall constitute a contract between the Buyer and Seller of each animal and shall be equally binding upon both. Each sale or resale of an animal constitutes a separate transaction.

B. Neither the sale manager, the owner, nor any other person connected with the management of the sale, assumes any liability, legal or otherwise.

# RAAA Herd EPD Tables

## Proven and Genetic Opportunity Sires (Spring 2023)

	ProS	HB	GM	CED	BW	WW	YW	ADG	DMI	MILK	ME	HPG	CEM	STAY	MARB	YG	CW	REA	FAT
Min.	-154	-152	-98	-4	-12.9	-15	-43	-.17	-1.11	-1	-35	-5	-9	-2	-.59	-1.05	-71	-1.13	-.22
<b>Avg.</b>	<b>91</b>	<b>54</b>	<b>37</b>	<b>13</b>	<b>-1.8</b>	<b>62</b>	<b>100</b>	<b>.23</b>	<b>1.46</b>	<b>25</b>	<b>3</b>	<b>11</b>	<b>7</b>	<b>15</b>	<b>.42</b>	<b>.06</b>	<b>24</b>	<b>.14</b>	<b>.02</b>
Max.	266	141	185	25	9.7	123	209	.54	3.60	44	37	23	19	27	1.90	.45	109	1.93	.11
1%	167	105	98	20	-6.9	92	151	.38	0.31	36	-23	18	12	22	.96	-.39	61	.96	-.08
2%	156	100	89	19	-6.3	88	144	.37	0.45	35	-17	18	12	21	.90	-.28	55	.81	-.05
3%	150	95	84	19	-6.0	86	140	.35	0.57	34	-14	17	11	21	.85	-.18	51	.70	-.03
4%	147	93	80	18	-5.6	84	137	.34	0.64	34	-12	17	11	20	.82	-.13	49	.64	-.02
5%	143	91	77	18	-5.5	82	135	.34	0.71	33	-11	16	11	20	.78	-.11	47	.60	-.02
<b>10%</b>	<b>132</b>	<b>82</b>	<b>67</b>	<b>17</b>	<b>-4.6</b>	<b>77</b>	<b>125</b>	<b>.31</b>	<b>0.90</b>	<b>31</b>	<b>-7</b>	<b>15</b>	<b>10</b>	<b>19</b>	<b>.71</b>	<b>-.05</b>	<b>41</b>	<b>.45</b>	<b>-.01</b>
15%	122	77	61	16	-4.1	74	120	.30	1.03	30	-4	15	9	18	.64	-.02	37	.38	.00
20%	116	73	55	15	-3.7	72	116	.28	1.12	29	-3	14	9	18	.59	.00	34	.32	.00
25%	111	69	51	15	-3.3	70	113	.27	1.20	29	-1	13	8	17	.56	.01	32	.28	.01
30%	106	66	48	14	-3.0	68	110	.27	1.27	28	0	13	8	17	.52	.03	30	.24	.01
35%	102	63	44	14	-2.6	66	107	.26	1.34	27	1	13	8	16	.49	.04	28	.20	.01
40%	98	60	41	13	-2.3	65	104	.25	1.40	27	2	12	8	16	.45	.05	26	.16	.01
45%	94	57	38	13	-2.1	63	102	.24	1.45	26	3	12	7	16	.43	.06	25	.13	.02
<b>50%</b>	<b>91</b>	<b>54</b>	<b>35</b>	<b>13</b>	<b>-1.8</b>	<b>62</b>	<b>100</b>	<b>.23</b>	<b>1.51</b>	<b>25</b>	<b>4</b>	<b>12</b>	<b>7</b>	<b>15</b>	<b>.41</b>	<b>.07</b>	<b>23</b>	<b>.11</b>	<b>.02</b>
55%	87	51	32	12	-1.5	60	97	.23	1.56	25	5	11	7	14	.38	.08	21	.08	.02
60%	83	48	29	12	-1.2	59	94	.22	1.62	24	6	11	6	14	.36	.09	20	.06	.02
65%	79	45	26	11	-0.9	58	92	.21	1.68	24	7	11	6	14	.33	.11	18	.02	.03
70%	75	42	23	11	-0.5	56	89	.20	1.74	23	8	10	6	13	.31	.12	16	.01	.03
75%	70	38	20	10	-0.2	54	86	.19	1.81	22	9	10	5	13	.28	.13	14	-.02	.03
80%	65	33	17	10	0.2	53	83	.18	1.89	21	10	9	5	12	.25	.14	13	-.06	.04
85%	58	28	12	9	0.7	50	79	.17	1.97	20	11	9	5	11	.21	.16	10	-.10	.04
<b>90%</b>	<b>50</b>	<b>21</b>	<b>7</b>	<b>8</b>	<b>1.3</b>	<b>47</b>	<b>74</b>	<b>.15</b>	<b>2.09</b>	<b>19</b>	<b>13</b>	<b>8</b>	<b>4</b>	<b>10</b>	<b>.16</b>	<b>.18</b>	<b>7</b>	<b>-.15</b>	<b>.05</b>
95%	38	9	-0.5	7	2.3	42	65	.13	2.26	17	16	7	3	9	.10	.22	2	-.23	.06

## Active Cows (Spring 2023)

	ProS	HB	GM	CED	BW	WW	YW	ADG	DMI	MILK	ME	HPG	CEM	STAY	MARB	YG	CW	REA	FAT
Min.	-117	-100	-50	-4	-12.0	0	0	-.02	-0.38	-3	-40	-2	-7	0	-.31	-.88	-30	-.84	-.19
<b>Avg.</b>	<b>91</b>	<b>60</b>	<b>31</b>	<b>12</b>	<b>-1.6</b>	<b>58</b>	<b>92</b>	<b>.21</b>	<b>1.37</b>	<b>25</b>	<b>2</b>	<b>11</b>	<b>7</b>	<b>16</b>	<b>.39</b>	<b>.06</b>	<b>20</b>	<b>.08</b>	<b>.02</b>
Max.	213	160	126	26	8.2	102	169	.47	3.22	51	61	26	15	29	1.41	.43	80	1.67	.10
1%	147	107	76	19	-6.4	81	132	.33	0.47	37	-16	18	11	23	.83	-.14	45	.58	-.02
2%	141	102	71	18	-5.9	79	128	.32	0.55	35	-14	17	11	22	.78	-.10	43	.52	-.02
3%	137	99	68	17	-5.6	77	125	.31	0.62	35	-12	17	10	22	.74	-.08	41	.48	-.01
4%	134	96	65	17	-5.3	76	123	.31	0.68	34	-11	16	10	21	.72	-.07	39	.44	-.01
5%	132	94	63	17	-5.1	75	121	.30	0.72	34	-10	16	10	21	.70	-.06	38	.42	-.01
<b>10%</b>	<b>122</b>	<b>86</b>	<b>56</b>	<b>16</b>	<b>-4.4</b>	<b>71</b>	<b>115</b>	<b>.28</b>	<b>0.88</b>	<b>32</b>	<b>-7</b>	<b>15</b>	<b>9</b>	<b>20</b>	<b>.62</b>	<b>-.03</b>	<b>34</b>	<b>.33</b>	<b>.00</b>
15%	116	81	51	15	-3.8	69	111	.27	0.99	30	-4	14	9	19	.57	-.01	31	.27	.00
20%	111	76	47	14	-3.4	67	108	.26	1.07	29	-3	14	8	19	.53	.01	29	.23	.00
25%	107	73	43	14	-3.1	65	105	.25	1.14	29	-2	13	8	18	.50	.02	27	.19	.00
30%	103	70	40	14	-2.7	64	102	.24	1.21	28	0	13	8	18	.47	.03	25	.16	.01
35%	99	67	38	13	-2.4	62	100	.24	1.26	27	1	12	8	17	.45	.04	24	.13	.01
40%	96	64	35	13	-2.1	61	98	.23	1.32	27	1	12	7	17	.42	.05	23	.11	.01
45%	93	61	33	12	-1.8	60	95	.22	1.37	26	2	12	7	16	.39	.06	21	.09	.01
<b>50%</b>	<b>90</b>	<b>58</b>	<b>30</b>	<b>12</b>	<b>-1.6</b>	<b>59</b>	<b>93</b>	<b>.22</b>	<b>1.42</b>	<b>25</b>	<b>3</b>	<b>11</b>	<b>7</b>	<b>16</b>	<b>.37</b>	<b>.07</b>	<b>20</b>	<b>.07</b>	<b>.01</b>
55%	87	56	28	12	-1.3	57	91	.21	1.47	25	4	11	7	16	.35	.08	18	.05	.01
60%	83	53	25	11	-1.1	56	89	.20	1.52	24	5	11	7	15	.33	.09	17	.03	.02
65%	80	50	23	11	-0.8	55	87	.20	1.57	23	6	10	6	15	.31	.10	16	.01	.02
70%	76	47	20	11	-0.5	53	84	.19	1.62	23	6	10	6	14	.29	.11	14	-.02	.02
75%	72	44	18	10	-0.2	52	81	.18	1.68	22	7	10	6	14	.27	.12	13	-.05	.03
80%	68	40	15	10	0.2	50	78	.17	1.75	21	8	9	5	13	.25	.13	11	-.08	.03
85%	63	35	12	9	0.6	48	74	.16	1.83	20	10	9	5	13	.22	.14	9	-.11	.04
<b>90%</b>	<b>56</b>	<b>29</b>	<b>8</b>	<b>8</b>	<b>1.1</b>	<b>45</b>	<b>69</b>	<b>.15</b>	<b>1.92</b>	<b>19</b>	<b>11</b>	<b>8</b>	<b>4</b>	<b>12</b>	<b>.19</b>	<b>.16</b>	<b>6</b>	<b>-.15</b>	<b>.04</b>
95%	45	20	2	7	2.0	41	62	.12	2.07	17	14	7	3	10	.15	.19	2	-.22	.05

## Non-Parents (Spring 2023)

	ProS	HB	GM	CED	BW	WW	YW	ADG	DMI	MILK	ME	HPG	CEM	STAY	MARB	YG	CW	REA	FAT
Min.	-81	-85	-56	-4	-12.1	0	0	.00	-0.39	0	-40	-2	-7	-2	-.52	-.76	-30	-.66	-.17
<b>Avg.</b>	<b>94</b>	<b>55</b>	<b>39</b>	<b>13</b>	<b>-1.9</b>	<b>60</b>	<b>96</b>	<b>.22</b>	<b>1.40</b>	<b>25</b>	<b>2</b>	<b>11</b>	<b>7</b>	<b>15</b>	<b>.43</b>	<b>.06</b>	<b>23</b>	<b>.14</b>	<b>.02</b>
Max.	256	169	196	26	10.8	118	190	.51	3.05	45	33	38	17	28	1.58	.43	88	1.59	.12
1%	150	98	82	19	-6.5	83	136	.34	0.01	34	-19	17	11	21	.89	-.15	47	.62	-.03
2%	143	94	77	18	-6.0	81	132	.33	0.28	34	-17	16	11	21	.83	-.11	44	.55	-.02
3%	139	90	74	18	-5.6	79	129	.32	0.47	33	-15	16	11	20	.80	-.09	42	.50	-.01
4%	136	88	72	17	-5.4	78	127	.32	0.56	33	-14	15	10	20	.77	-.07	41	.48	-.01
5%	133	86	70	17	-5.2	77	125	.31	0.63	32	-13	15	10	20	.74	-.06	40	.45	-.01
<b>10%</b>	<b>124</b>	<b>79</b>	<b>62</b>	<b>16</b>	<b>-4.4</b>	<b>73</b>	<b>119</b>	<b>.29</b>	<b>0.84</b>	<b>31</b>	<b>-8</b>	<b>14</b>	<b>9</b>	<b>19</b>	<b>.65</b>	<b>-.03</b>	<b>36</b>	<b>.37</b>	<b>.00</b>
15%	118	75	57	15	-3.9	71	115	.28	0.97	30	-5	14	9	18	.60	-.01	33	.31	.00
20%	113	71	53	15	-3.5	69	111	.27	1.08	29	-3	13	9	18	.56	.01	31	.28	.00
25%	109	68	50	14	-3.2	67	109	.26	1.17	28	-1	13	8	17	.53	.02	30	.24	.01
30%	105	65	47	14	-2.9	66	106	.25	1.24	28	0	12	8	17	.50	.03	28	.22	.01
35%	102	63	44	14	-2.6	64	104	.25	1.31	27	1	12	8	16	.47	.04	27	.19	.01
40%	99	60	42	13	-2.3	63	101	.24	1.36	27	2	12	8	16	.45	.05	25	.17	.01
45%	96	58	40	13	-2.1	62	99	.23	1.42	26	3	12	7	16	.43	.06	24	.14	.02
<b>50%</b>	<b>93</b>	<b>55</b>	<b>37</b>	<b>13</b>	<b>-1.8</b>	<b>60</b>	<b>97</b>	<b>.23</b>	<b>1.47</b>	<b>26</b>	<b>3</b>	<b>11</b>	<b>7</b>	<b>15</b>	<b>.41</b>	<b>.07</b>	<b>23</b>	<b>.12</b>	<b>.02</b>
55%	90	53	35	12	-1.6	59	95	.22	1.52	25	4	11	7	15	.39	.07	22	.10	.02
60%	87	50	33	12	-1.3	58	92	.21	1.57	24	5	11	7	15	.37	.08	21	.08	.02
65%	84	48	30	12	-1.0	56	90	.21	1.62	24	6	11	6	14	.35	.09	19	.06	.02
70%	80	45	28	11	-0.8	55	87	.20	1.67	23	7	10	6	14	.33	.10	18	.03	.03
75%	77	42	25	11	-0.5	53	84	.19	1.73	23	7	10	6	13	.31	.11	16	.01	.03
80%	73	39	22	10	-0.1	51	81	.18	1.79	22	8	10	6	13	.29	.12	15	-.02	.03
85%	69	35	19	10	0.2	49	77	.17	1.86	21	10	9	5	12	.26	.14	13	-.05	.04
<b>90%</b>	<b>63</b>	<b>30</b>	<b>14</b>	<b>9</b>	<b>0.7</b>	<b>46</b>	<b>71</b>	<b>.15</b>	<b>1.95</b>	<b>20</b>	<b>11</b>	<b>9</b>	<b>5</b>	<b>11</b>	<b>.23</b>	<b>.15</b>	<b>10</b>	<b>-.09</b>	<b>.04</b>
95%	54	23	8	8	1.6	41	62	.13	2.08	19	13	8	4	10	.18	.18	6	-.15	.05

## EPD Accuracies and Possible Change

EPDs are predictions, not true values, and we can therefore expect that EPDs will change from sire evaluation, as more information (i.e. progeny data) is included. A possible change value is an estimate of the amount of change (in trait units) that can be expected for a given EPD.

Technically, there is a 68% chance that the real genetic value (an EPD with an accuracy of 1.0) for any trait lies between its EPD plus its possible change value and its EPD minus its possible change value. For example, if a sire has a weaning EPD of +25 lb. and a possible change value of 10 lb., we can expect the true genetic value to be between +15 lb. (25 - 10) and +35 lb. (25 + 10) 68% of the time. We should not be surprised if his EPD in next year's evaluation is as high as +35 or as low as +15. If next year's EPD should happen to be slightly outside of this range, keep in mind

there is nearly a one-in-three chance of that happening; however, significantly larger deviations can occur.

Possible change is simply another way of expressing accuracy of an EPD. High accuracy sires will have small possible changes and vice versa. Many breeders feel that possible change values complement accuracies and help them determine just how thoroughly an animal has been evaluated. The accuracy/possible change chart lists possible changes in EPDs that can be expected with different levels of accuracy for the various traits.

For more information on possible change values, please see the article by Dr. Bob Hough titled "Understanding EPD Accuracies and Possible Change". This article can be downloaded from the Red Angus Association of America website at [www.redangus.org](http://www.redangus.org).

Accuracy	CED	BW	WW	YW	DMI	MILK	ME	HPG	CEM	STAY	MARB	YG	CW	REA	FAT
<b>0.0</b>	7.8	3.0	16.3	25.7	.92	11.9	3	11	7.9	7.1	.26	.20	19.3	.43	.04
<b>0.1</b>	7.0	2.7	14.7	23.1	.82	10.7	2	10	7.1	6.4	.23	.18	17.4	.39	.04
<b>0.2</b>	6.2	2.4	13.0	20.6	.73	9.5	2	9	6.3	5.7	.21	.16	15.4	.34	.03
<b>0.3</b>	5.4	2.1	11.4	18.0	.64	8.3	2	8	5.5	4.9	.18	.14	13.5	.30	.03
<b>0.4</b>	4.7	1.8	9.8	15.5	.55	7.1	2	7	4.7	4.2	.16	.12	11.6	.26	.02
<b>0.5</b>	3.9	1.5	8.2	12.9	.46	6.0	1	6	3.9	3.5	.13	.10	9.7	.22	.02
<b>0.6</b>	3.1	1.2	6.5	10.3	.37	4.8	1	4	3.1	2.8	.10	.08	7.7	.17	.02
<b>0.7</b>	2.3	0.9	4.9	7.7	.27	3.6	1	3	2.4	2.1	.08	.06	5.8	.13	.01
<b>0.8</b>	1.6	0.6	3.3	5.1	.18	2.4	1	2	1.6	1.4	.05	.04	3.9	.09	.01
<b>0.9</b>	0.8	0.3	1.6	2.6	.09	1.2	0	1	0.8	0.7	.03	.02	1.9	.04	.00
<b>1.0</b>	0.0	0.0	0.0	0.0	.00	0.0	0	0	0.0	0.0	.00	.00	0.0	.00	.00

# Sire Bloodline Charts

Name Family

- Accent A
- Allegiant O
- Cadinal C
- Cherokee C
- Clifftop C
- Clipper A
- Cody A
- Dominor D
- Epic E
- Herald H
- Heritage H
- Hughes B
- Hustler H
- Javelin J
- Jet J
- Julian J
- Lancer L
- RH Lancer O
- Legend L
- Likable L
- Nebula N
- New Era N
- Oracle O
- President O
- Ranger R
- Roosevelt B
- Scamp S
- Warrior W

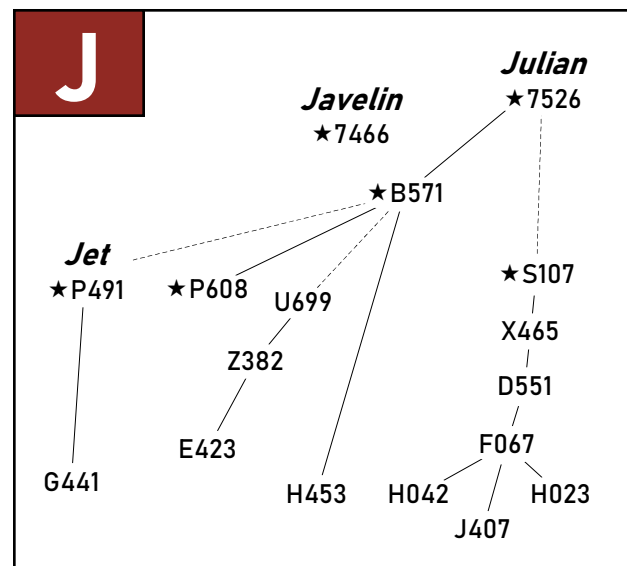
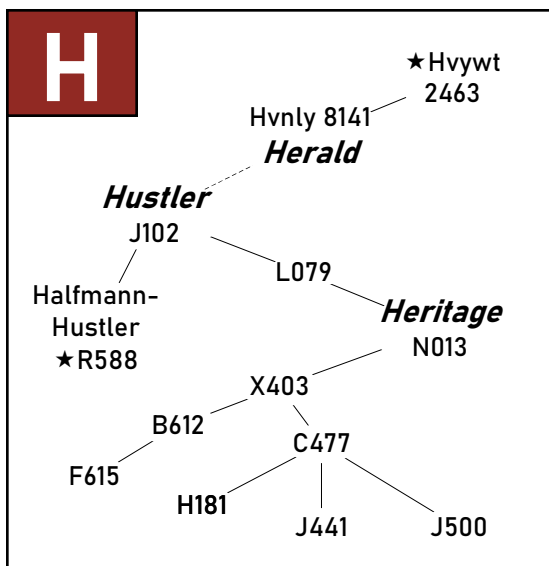
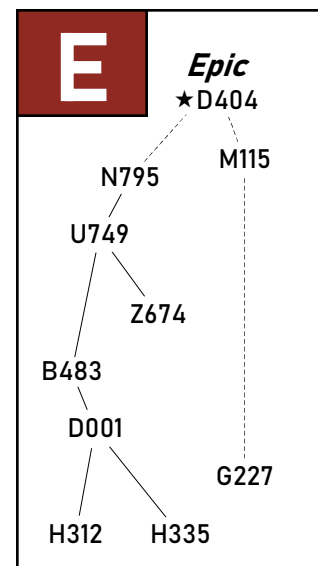
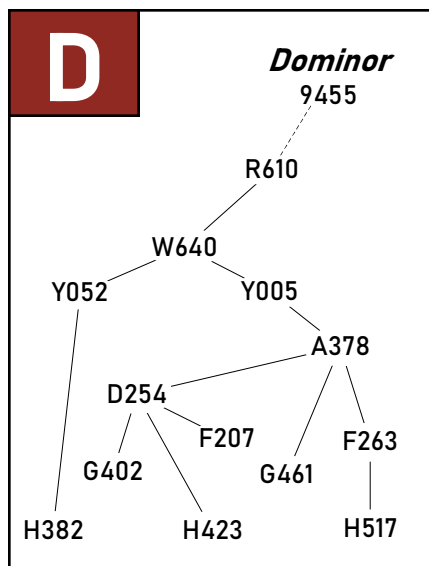
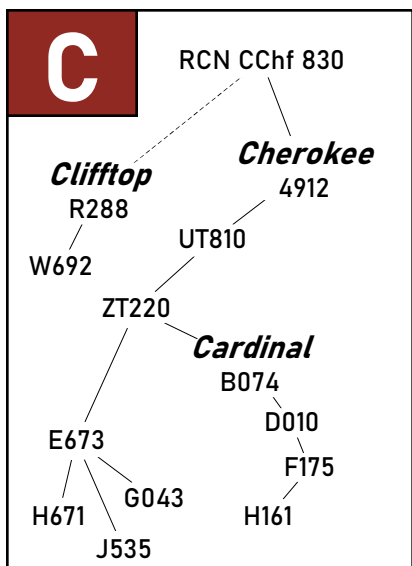
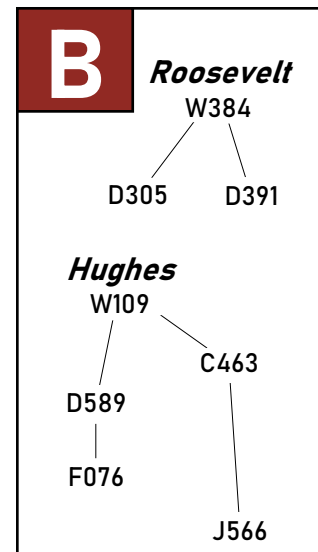
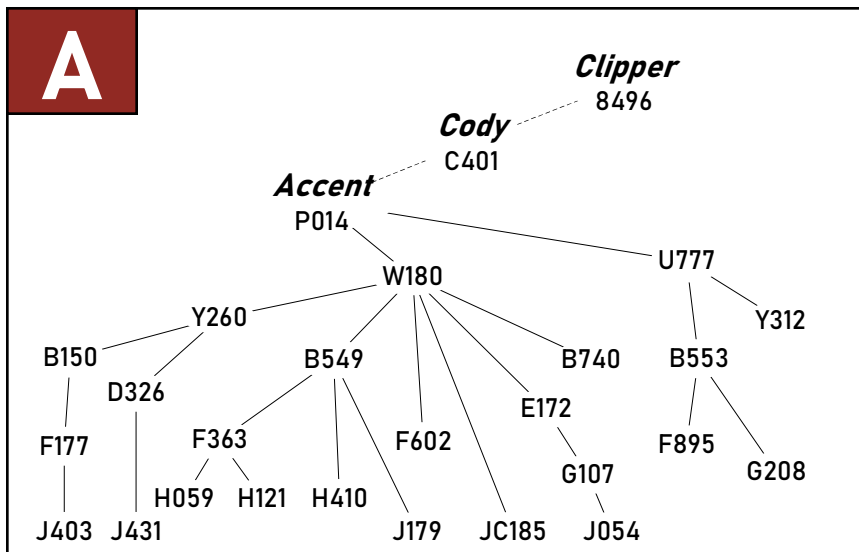

★ Red Angus Trait Leader

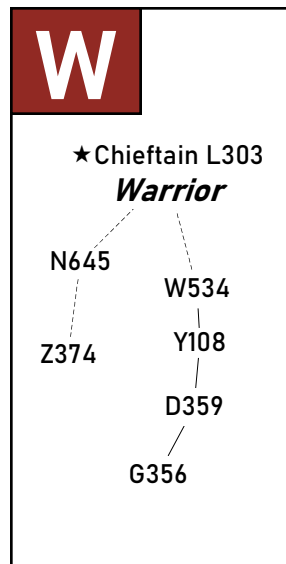
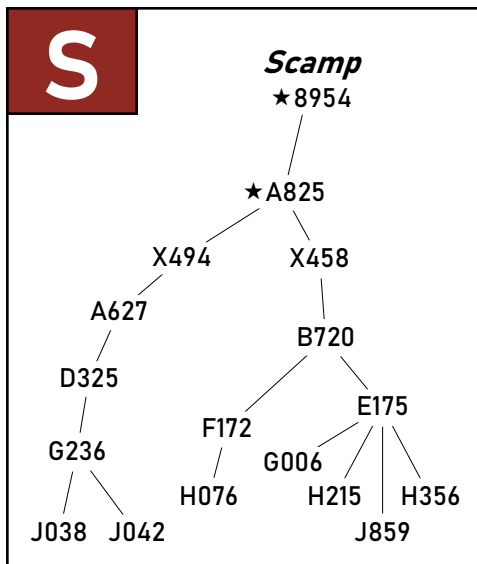
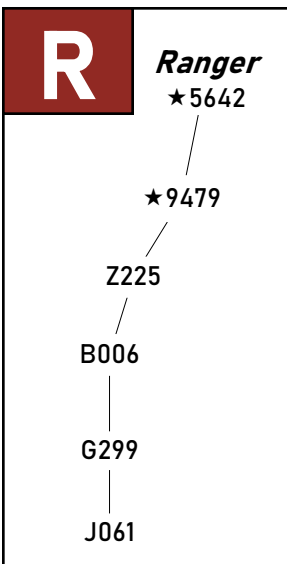
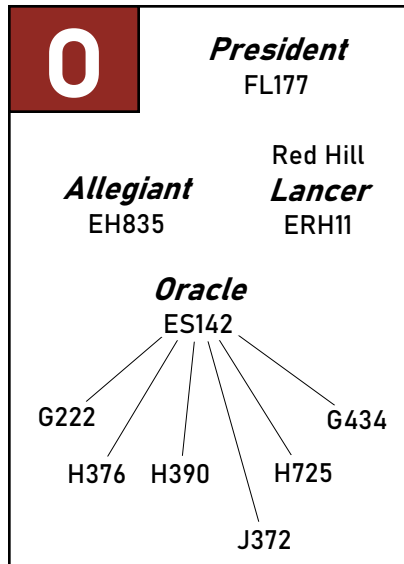
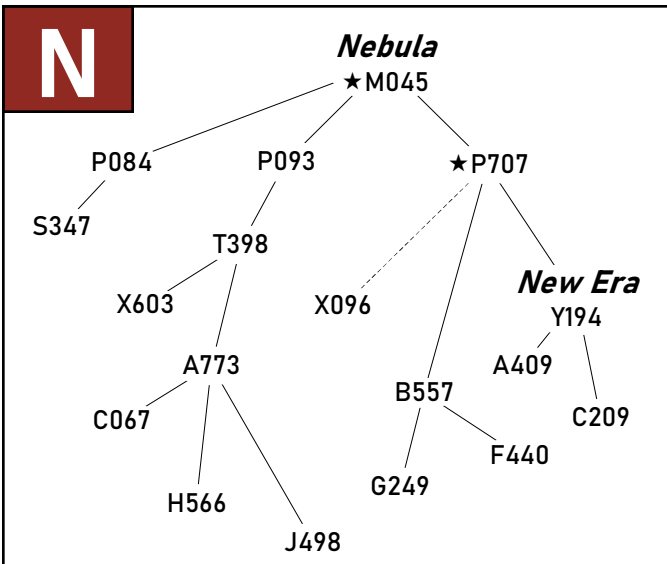
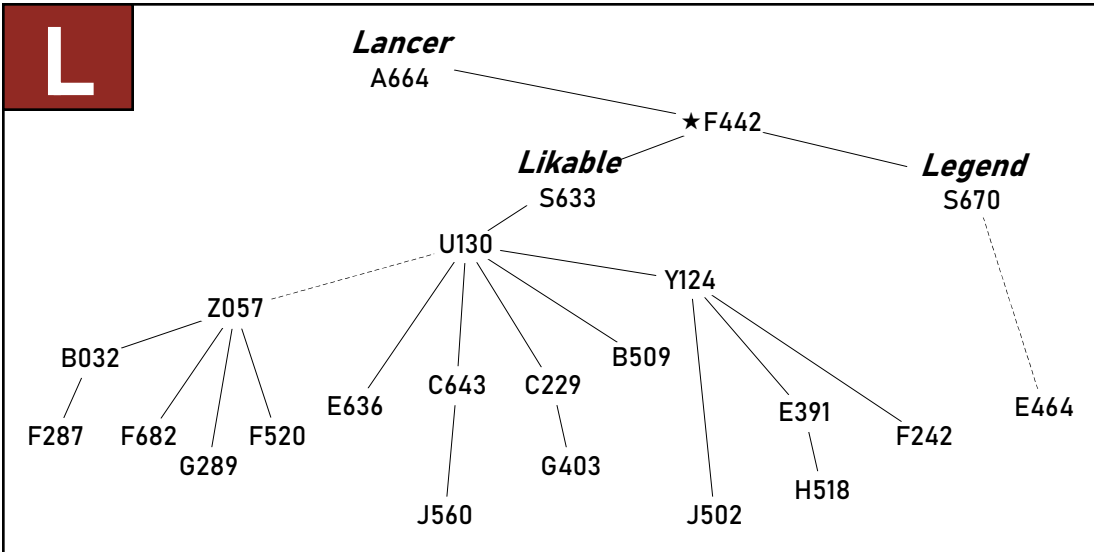

Name	Tag	Family
Nebula	A773	N-2
Likable	B032	L-1
Accent	B549	A-2
Julian	B571	J-1
Accent	B740	A-3
Likable	C229	L-2
Scamp	E175	S-1
Julian	E423	J-3
Likable	E636	L-3
Cardinal	E673	C-1
RH Lancer	ERH11	O-1
Oracle	ES142	O-2
Julian	F067	J-4
Hughes	F076	B-1
Dominator	F263	D-1
Likable	F287	L-4
Nebula	F440	N-3
Accent	F602	A-4
Heritage	F615	H-1
President	FL177	O-3
Scamp	G006	S-2
Cardinal	G043	C-2
Accent	G107	A-5
Accent	G208	A-6
Oracle	G222	O-4
Epic	G227	E-1
Scamp	G236	S-3
Nebula	G249	N-4
Likable	G289	L-5
Ranger	G299	R-1
Warrior	G356	W-1
Dominator	G402	D-2
Likable	G403	L-6
Jet	G441	J-5
Julian	H023	J-6
Julian	H042	J-7
Accent	H059	A-7
Scamp	H076	S-4
Accent	H121	A-8
Heritage	H181	H-2
Epic	H312	E-2
Epic	H335	E-3
Dominator	H382	D-3
Oracle	H390	O-5
Accent	H410	A-9
Dominator	H423	D-4
Likable	H518	L-7
Nebula	H566	N-5
Cardinal	H671	C-3
Accent	W180	A-1
New Erra	Y194	N-1
Julian	Z382	J-2

# Lot-Tag Cross Reference

ID	Lot	ID	Lot	ID	Lot	ID	Lot	ID	Lot	ID	Lot	ID	Lot
<b>Bulls</b>								<b>Heifers</b>				<b>Ref. Sires</b>	
K002	97	K233	41	K410	143	K588	126	K784	163	K026	328	A773	N-2
K024	113	K235	81	K412	194	K595	127	K786	181	K115	331	B032	L-1
K029	165	K238	145	K419	236	K599	228	K804	89	K158	301	B549	A-2
K051	129	K241	72	K421	25	K602	210	K815	144	K195	321	B571	J-1
K055	170	K242	146	K429	65	K604	124	K821	227	K211	308	B740	A-3
K067	57	K244	240	K431	58	K609	86	K823	189	K214	332	C229	L-2
K068	138	K246	33	K432	156	K610	190	K824	17	K222	303	E175	S-1
K070	102	K247	7	K435	152	K615	207	K826	121	K226	318	E423	J-3
K073	188	K250	3	K440	51	K619	200	K837	197	K228	327	E636	L-3
K079	149	K252	159	K441	178	K621	105	K838	12	K234	319	E673	C-1
K082	84	K266	30	K443	40	K629	130	K839	63	K282	310	ERH11	O-1
K087	87	K271	229	K444	64	K633	76	K840	160	K326	302	ES142	O-2
K095	98	K274	234	K445	174	K634	218	K841	116	K332	309	F067	J-4
K098	131	K275	213	K446	34	K636	52	K848	94	K342	307	F076	B-1
K099	168	K279	125	K455	104	K641	161	K855	142	K347	306	F263	D-1
K101	59	K283	180	K456	29	K644	232	K863	212	K357	320	F287	L-4
K108	13	K284	48	K458	103	K650	107	K864	214	K380	305	F440	N-3
K113	185	K285	82	K460	83	K651	153	K866	182	K413	329	F602	A-4
K114	22	K287	186	K466	91	K653	112	K871	206	K425	311	F615	H-1
K116	184	K294	2	K467	79	K656	162	K880	202	K433	314	FL177	O-3
K122	221	K295	10	K468	220	K660	150	K923	203	K484	312	G006	S-2
K124	37	K299	118	K469	20	K663	231	K953	151	K494	324	G043	C-2
K126	53	K300	157	K472	70	K667	49	KC192	117	K507	315	G107	A-5
K130	45	K302	1	K473	219	K670	172	KC201	23	K535	304	G208	A-6
K131	196	K305	199	K475	62	K671	217	KC204	191	K554	317	G222	O-4
K132	123	K309	139	K486	239	K673	27	KC205	205	K559	316	G227	E-1
K133	141	K313	108	K488	226	K674	95	KC206	135	K596	323	G236	S-3
K137	120	K317	177	K490	26	K676	122	KC209	237	K635	325	G249	N-4
K143	68	K320	16	K491	233	K681	183	KC215	69	K655	322	G289	L-5
K145	101	K322	15	K496	55	K683	195			K675	326	G299	R-1
K148	111	K324	4	K497	119	K684	173			K722	313	G356	W-1
K152	100	K327	238	K505	24	K688	88			K763	330	G402	D-2
K154	19	K329	92	K506	167	K698	14					G403	L-6
K163	176	K331	224	K508	77	K702	96					G441	J-5
K170	164	K338	66	K509	44	K705	71					H023	J-6
K172	80	K343	73	K512	36	K714	192					H042	J-7
K176	31	K354	209	K516	132	K721	67					H059	A-7
K178	137	K358	169	K525	187	K723	90					H076	S-4
K181	154	K360	32	K529	140	K726	6					H121	A-8
K182	35	K361	11	K532	54	K728	230					H181	H-2
K186	21	K363	75	K539	78	K733	128					H312	E-2
K188	8	K365	208	K549	201	K737	93					H335	E-3
K191	43	K367	106	K550	171	K741	85					H382	D-3
K197	110	K378	61	K561	5	K753	235					H390	O-5
K202	39	K379	50	K564	175	K761	216					H410	A-9
K205	136	K382	38	K570	155	K766	222					H423	D-4
K206	133	K383	225	K572	211	K767	56					H518	L-7
K212	223	K391	114	K574	148	K770	134					H566	N-5
K213	74	K396	18	K575	158	K771	147					H671	C-3
K223	215	K400	28	K576	193	K773	60					W180	A-1
K225	109	K404	9	K577	198	K775	166					Y194	N-1
K232	115	K405	99	K583	46	K778	42					Z382	J-2
		K406	179	K585	204	K782	47						

# Family who help us in many ways over the course of the year



Shelley Forbes and Jason Brown  
with Nolan and Emery



Tallie Forbes and Justin Lee  
with Claire and Ryan



Don Bingham and Alison Brody with Kate



Morgan Baldwin and Stephen Forbes



Cam and Trish Forbes  
wrangling grandkids Claire and Ryan



Doug Foster  
and Sarah Forbes



Julia Forbes & Ed Waddington  
(with Tazmin and Flinder)



Keenan Forbes and Onn Bunmat, Ellen Durkin,  
Jo and Spike Forbes, and Julia and Sarah Durkin



Sheila and Doug Bingham



Elfie Forbes

**Thank you!**

# Beckton Stock Farm

Cam Forbes  
37 Beckton Drive  
Sheridan, WY 82801

Tel.: 307.674.6095, 674.8162 (evening)

Email: [becktonwyo@gmail.com](mailto:becktonwyo@gmail.com)

Web: [www.BecktonRedAngus.com](http://www.BecktonRedAngus.com)

Video of Sale Bulls available on our Website

## FIRST CLASS

Industry leading genetics and the highest quality  
Red Angus, with 78 years of Satisfied Customers



Superior Productions will provide internet and representative bidding services for buyers who can't make it to the sale. Please see page 3 for more information.

**Free Delivery**  
anywhere in the Continental US